



# catalogue

Healthcare Equipment  
Products & Services















## VIC

-  **Thomastown**  
9 Temple Drive,  
Thomastown VIC  
Phone: 03 9981 2100
-  **Brunswick East**  
82 Albion Street,  
Brunswick East VIC  
Phone: 03 9981 2100
-  **Cheltenham**  
313 Warrigal Road,  
Cheltenham VIC  
Phone: 03 9584 1644
-  **Geelong**  
38-42 Mercer Street,  
Geelong VIC  
Phone: 03 5223 2263
-  **Bendigo**  
51 Bridge Street,  
Bendigo VIC  
Phone: 03 5441 8213
-  **Mildura**  
18 Eighth Street,  
Mildura VIC  
Phone: 03 5022 0755
-  **Epping**  
710 High Street,  
Epping VIC  
Phone: 03 9981 2220

## NSW

-  **Wollongong**  
140 Church Street,  
Wollongong NSW  
Phone: 02 8706 2359
-  **Moorebank**  
3A, 1 Moorebank Ave,  
Moorebank NSW  
Tel: 02 8706 2300
-  **Seven Hills**  
2/4 Stanton Road,  
Seven Hills NSW  
Phone: 02 8706 2330
-  **Blacktown**  
1/34 Campbell Street  
Blacktown NSW  
Phone: 02 9621 4077
-  **Central Coast**  
2/12 Aston Road,  
Erina NSW  
Phone: 02 4367 5751
-  **Albury**  
347 Urana Road,  
Lavington NSW  
Phone: 02 6040 3444
-  **Orange**  
Unit 1, 12-16 Ash Street,  
Orange NSW  
Phone: 0437 134 295

-  **Tamworth**  
3/248 Peel Street,  
Tamworth NSW  
Phone: 02 6761 2018
-  **Port Macquarie**  
1/171 Lake Rd  
Port Macquarie NSW  
Phone: 02 6581 0018
-  **Coffs Harbour**  
2/177 Orlando Street,  
Coffs Harbour NSW  
Phone: 02 6651 5333
-  **Ballina**  
18 Endeavour Close,  
Ballina NSW  
Phone: 02 6686 6644

-  **Toowoomba**  
3/342 Taylor Street,  
Toowoomba QLD  
Phone: 07 3086 2990
-  **Sunshine Coast**  
Unit 2, 35 Premier Circuit,  
Warana QLD  
Phone: 07 3086 2980
-  **Hervey Bay**  
Shop 3, 19 Islander Road,  
Pialba QLD  
Phone: 07 4194 5019

## TAS

-  **Hobart**  
18 Mertonvale Circuit,  
Kingston TAS  
Phone: 03 6229 4733



-  **Launceston**  
Unit 8, 34 Innocent Street,  
Kings Meadows TAS  
Phone: 03 6344 8922

## SA

-  **North Adelaide**  
21 - 23 Tikalara Street,  
Regency Park SA  
Phone: 08 8118 5600

-  **South Adelaide**  
550 Marion Road,  
Plympton Park SA  
Phone: 08 8118 5680

## QLD

-  **Acacia Ridge**  
30 Dulacca Street,  
Acacia Ridge QLD  
Phone: 07 3086 2900
-  **Geebung**  
354 Bilsen Road,  
Geebung QLD  
Phone: 07 3086 2950
-  **Gold Coast**  
Units 1-2, 48 Olympic Cct,  
Southport QLD  
Phone: 07 5532 6070

## National Distribution Network

- |   |  |
|---|--|
|  Thomastown     |  Tamworth       |
|  Brunswick East |  Port Macquarie |
|  Cheltenham     |  Coffs Harbour  |
|  Geelong        |  Ballina        |
|  Bendigo        |  Acacia Ridge   |
|  Mildura        |  Geebung        |
|  Epping         |  Gold Coast     |
|  Wollongong     |  Toowoomba      |
|  Moorebank      |  Sunshine Coast |
|  Seven Hills    |  Hervey Bay     |
|  Blacktown      |  Hobart         |
|  Central Coast  |  Launceston     |
|  Albury         |  Regency Park   |
|  Orange         |  Plympton Park  |

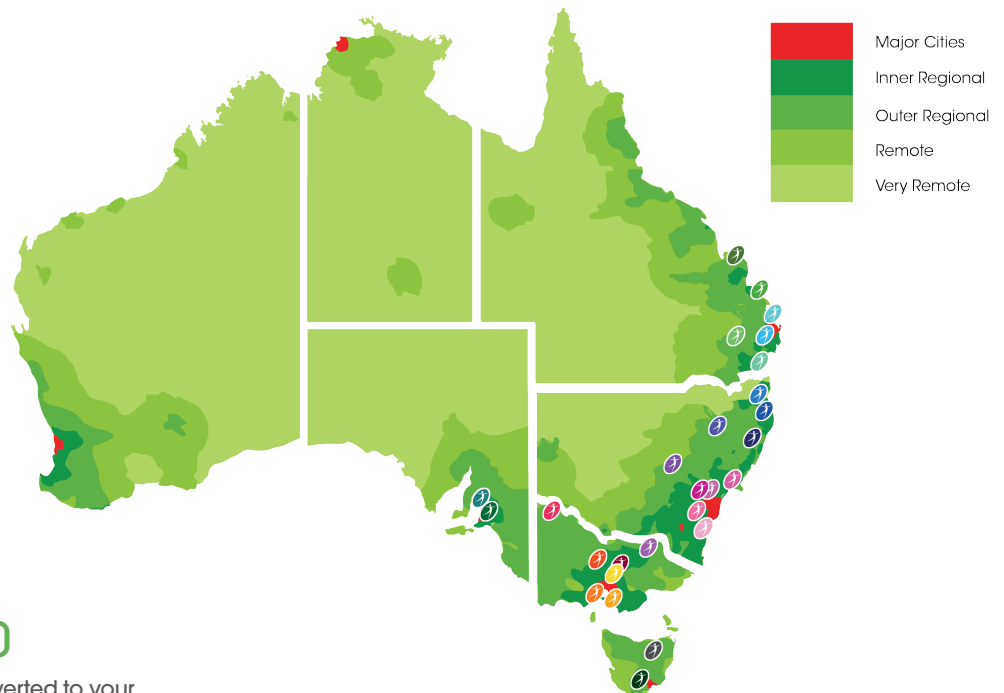

**CALL 1300 133 120**

Call this number to be automatically diverted to your local Aidacare office (for the price of a local call).

## Aged Care Facilities



Room Furnishings



Living Areas



Leisure

## Home & Community



Mobility



Care



Independence

## Hospitals



Ward Furnishings



Trolleys & Carts



Utility Rooms

## Complex Rehab



Consultation



Equipment



Training

## NDIS

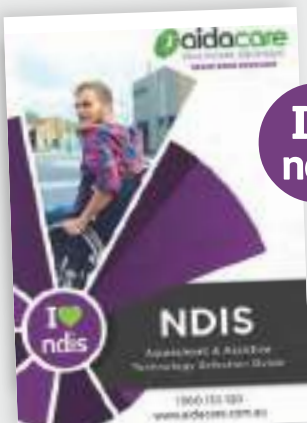

I ♥  
ndis

For NDIS Item Code,  
refer to page: 508

Look for this  
symbol for NDIS

## DVA



✓

Look for this symbol  
for DVA



## Rental Equipment & Discharge

The industry's most comprehensive range of equipment available for rental.  
Delivered and set-up in the home.  
Discharge and Package Management solutions available.  
Rental brochure available on request.



## Preventative Maintenance & Repairs

Risk Management - ensure your equipment is serviced and maintained regularly to reduce the risk of breakdowns and to assist managing your accreditation requirements.  
Asset tracking and equipment audit included.



## Fit-Outs & Refurbishment

We work with you and your Interior Architect to get the look and function you want in your facility.  
We install, commission and support all our equipment bringing you value and peace-of-mind. Featured ranges: Ceiling Hoist Systems; Sanitisers and Macerators; Bedroom Fit-out; Furniture & Furnishings; Laundry and Kitchen.



## Retail Showrooms

Visit one of our showrooms where our friendly staff can help you identify the right solution for your needs.  
Utilise our showrooms as training centres or locations to trial equipment with your clients.



## Home Modifications

We arrange installation of rails, ramps, non-slip flooring and many other items to ensure your home is safe and mobility friendly.

# Aidacare Resources

## Aidacare Online



[www.aidacare.com.au](http://www.aidacare.com.au)

## eRAP: DVA Prescriber Portal



[erap.aidacare.com.au](http://erap.aidacare.com.au)  
1300 888 052



## FF&E Experience Centre

Project & Fitout Solutions by Aidacare is a dedicated, visually-tailored solution for Furniture, Fittings & Equipment. A one-stop solution for Aged Care Greenfield & Brownfield developments and Commercial projects.

**Only 10 minutes from Melbourne Tullamarine Airport.**



## Product Application Guides Available on Request



### DVA Contact Details

P 1300 888 052 | F 1300 787 052 | E [dva@aidacare.com.au](mailto:dva@aidacare.com.au)



For NDIS Item Code, refer to page: 508





## Home Modifications

P 012

Home Modifications .....012



## Bariatric

P 013

What is Bariatric Equipment .....014	Mobility Scooters.....016
Bathroom & Toilet .....014	Mobility Ramps.....017
Bedroom.....015	Mobility Walking Frames & Aids .....017
Chairs - Therapeutic .....015	Mobility Wheelchairs & Positioning .....017
Cushions & Seating .....016	Hospital & Ward Equipment .....017
Manual Handling - Lifters & Slings.....016	



## Bathroom & Toilet

P 018

Aspire Shower Commodes.....020	Other Toileting Aids.....041
Verto Shower Commodes .....027	Transfer Aids .....044
Aquatec Shower Commodes.....028	Other Bathing .....047
K Care Shower Commodes .....029	Bathroom Trolleys .....051
Shower Seating .....032	Bed Pans, Urinals & Bowls .....053
Toileting Aids .....038	Grab Rails .....055



## Bedroom

P 060

Home Care Beds .....062	Bedside Commodes .....081
Aged Care Beds.....066	Overbed Tables .....083
Mattress Overview .....070	Bedroom Furnishings.....086
Mattress Safety, Support & Protection.....071	Bed Sticks, Bed Poles & Other .....089
Underlays & Overlays - Foam.....072	Pillows & Supports .....092
Mattresses - Foam.....073	Sleep Positioning Aids .....094
Mattresses - Alternating Air .....078	Falls Prevention & Alarms.....096
Mattresses - Other .....080	



## Chair & Table Furnishings

P 099

Dining Chairs .....101	Dining Tables.....105
Lounge Chairs.....103	Coffee Tables .....106
Lounge Sofas.....104	Office Chairs & Tables .....106



## Chairs - Therapeutic

P 107

Adjustable Height Day Chairs .....109	Pressure Relief Chairs .....118
Powerlift & Recline Chairs .....114	



## Continence

P 123

Bedding & Chair Protectors .....125	Clothing Protectors - Reusable .....129
Clothing Protectors - Disposable .....127	



## Cushions & Seating

P 131

Cushions & Back Supports .....130	Pressure Care Cushions .....133
-----------------------------------	---------------------------------



## Daily Living Aids

P 156

Dressing Aids .....157	Crockery .....165
Kitchen Aids.....159	Reaching Aids .....167
Gripping & Turning Aids.....161	General Household & Dementia Aids.....168
Cutlery .....163	



## Laundry & Cleaning

P 173

Linen Skips .....175	Other Trolleys .....180
Clean Linen & Storage.....178	Kitchen Trolleys .....182



## Manual Handling - Lifters & Slings

P 184











Aspire Lifters .....186	Gantry Systems .....206
Aspire Slings.....190	Oxford Lifters & Slings .....208
Aspire Swift Patient Mover.....193	Invacare Lifters & Slings .....212
Liko Lifters .....194	Kerry Lifters & Slings .....215
Liko Slings .....196	Stair & Speciality Lifters .....216
Ceiling Hoists.....200	



## Manual Handling - Other

P 217

Transfer Boards & Slide Sheets .....219	Other Transfer Aids.....222
Transfer & Walk Belts.....221	

	<b>Mobility Scooters</b>	<b>P 224</b>
	Mobility Scooters.....225	Scooter Servicing .....230
	Scooter Selection Guide.....229	Scooter Accessories.....231
	<b>Mobility Ramps</b>	<b>P 233</b>
	Modular & Rubber Ramps.....235	Custom Ramps (DVA Home Mods).....012
	<b>Paediatric</b>	<b>P 238</b>
	Strollers & Walking Frames.....240	Paediatric Cots.....248
	Seating & Standing Aids.....243	Other Paediatric.....250
	<b>Mobility Walking Frames &amp; Aids</b>	<b>P 252</b>
	Seat Walkers / Rollators & Accessories.....253	Walking Sticks.....266
	Walking Frames.....262	Crutches.....268
	Forearm Walkers.....264	General Accessories.....270
	<b>Mobility Wheelchairs &amp; Positioning</b>	<b>P 271</b>
	Aspire Manual Wheelchairs.....272	Tilite Manual Wheelchairs.....291
	Aspire Wheelchair Accessories.....278	Quantum Power Wheelchairs.....292
	Other Manual Wheelchairs.....282	Ottobock Power & Manual Wheelchairs.....293
	Standard Power Wheelchairs.....286	Invacare Power & Manual Wheelchairs.....294
	Sunrise Medical Power & Manual Wheelchairs.....288	Wheelchair Backrests.....395
	Permobil Power Wheelchairs.....290	General Wheelchair Accessories.....306
	<b>Utility &amp; Pan Room</b>	<b>P 310</b>
	Range Overview & Cross-Infection Control.....312	Plasticware & Consumables.....316
	Washer Sanitisers & Macerators.....313	
	<b>Hospital &amp; Ward Equipment</b>	<b>P 318</b>
	Hospital Beds.....320	Patient Hygiene.....344
	Mattresses - Acute Care.....322	Patient Handling - Mobile.....346
	Maternity Beds & Birthing.....325	Patient Handling - Ceiling Hoists.....351
	Patient Trolley.....329	Ward Carts.....354
	Examination Couches & Equipment.....331	Instrument / Dressing Trolleys.....357
	Treatment Chairs.....334	Other Trolleys & Carts.....359
	Pressure Care Seating.....337	Weigh Chairs & Scales.....361
	Ward Furniture & Seating.....339	General Ward Equipment.....363
	Patient Transport & Mobility.....342	
	<b>Hospital Mortuary &amp; Funeral Homes</b>	<b>P 368</b>
	Funeral Home & Mortuary Equipment.....370	
	<b>Therapy &amp; Exercise</b>	<b>P 375</b>
	Exercise & Resistance Training.....376	Bracing & Supports - Wrist & Hand.....400
	Physiotherapy - Other.....380	Bracing & Supports - Knee.....416
	Enteral Feeding Pumps & Accessories.....383	Bracing & Supports - Thigh & Calf.....425
	Bracing & Supports - Neck & Shoulder.....385	Bracing & Supports - Ankle.....427
	Bracing & Supports - Trunk & Back.....389	Bracing & Supports - Foot & Toe.....432
	Bracing & Supports - Arm & Elbow.....395	Male Support.....440
	<b>Pressure Care &amp; Circulation</b>	<b>P 442</b>
	Protection - General.....444	Donning & Doffing Aids.....(Refer to pg 155)
	Protection - Hip.....448	Mattresses - Alternating Air.....(Refer to pg 075)
	Protection - Skin & Limb.....453	Pressure Relief Chairs.....(Refer to pg 115)
	Compression - Legwear.....457	Pressure Care Cushions.....(Refer to pg 133)
	Compression - Armwear.....490	
	<b>NDIS Assessment &amp; Assistive Technology</b>	<b>P 503</b>
	Introducing NDIS & Aidacare.....504	Product Index.....508
	Assessment Form.....505	Maintenance & Service.....521

# DVA: Ordering Guide

RAP Code	Category	Prior Approval Required	Veteran Limit	Eligible Prescriber	Hire or Buy
AA16	Sensor Mat - Low Frequency	No	-	OT/RN/Phys/LMO	Buy
AB01	Bed - Adjustable Electrical	No	1 Per Person	OT/RN/Phys/ LMO/S/Ch/Ost	Hire
AB02	Bed Backrests - Manual	No	-	OT/Phys/RN/LMO/S/Ch/Ost	Buy
AB03	Bed Blocks	No	-	OT/Phys/RN/LMO/S/Ch/Ost	Buy
AB06	Bed Cradles	No	-	OT/Phys/RN/LMO/S/Ch/Ost/Pod	Buy
AB08	Bed Sticks	No	-	OT/RN/Phys/ LMO/S/Ch/Ost	Buy
AB09	Bedside Rails	No	-	OT/RN/Phys/ LMO/S/Ch/Ost	Buy
AB11	Sheepskin Rugs / Foot / Heel / Elbow Pads (Medical Type Only)	No	-	OT/Phys/RN/LMO/S/Pod/Ch/Ost	Buy
AB12	Monkey Bar / Self-Lifting Stand	No	-	OT/RN/Phys/LMO/S/Ch/Ost	Hire
AB13	Table - Overbed	No	-	OT/Phys/RN/LMO/S/Ch/Ost	Buy
AB14	Pressure Care Mattress	No	-	OT/Phys/RN/LMO/Pod/S/Ch/Ost	Buy
AB16	Replacement Parts / Repairs for AB Items	No	-	OT/Phys/RN/LMO/S/Ch/Ost/POD	Buy
AB17	Heel Elevators for Pressure Care	No	-	OT/Phys/RN/LMO/S/Pod	Buy
AC01	Chair - Low / High Back	No	-	OT/Phys/RN/S/LMO/Ch/Ost	Buy
AC03	Stool - Height Adjustable	No	-	OT/Phys/RN/S/LMO/Ch/Ost	Buy
AC04	Chair - Platform / Blocks	No	-	OT/Phys/RN/S/LMO/Ch/Ost	Buy
AC06	Chair - Electrically Operated Lift and Recliner Chair	No	1 Per Person	OT/Phys/S/LMO/Ch/Ost	Hire
AC07	Footstool - Height Adjustable	No	-	OT/Phys/RN/S/LMO/Ch/Ost	Buy
AC08	Chair - Fallout / Water	No	1 Per Person	OT/Phys/RN/S/LMO/Ch/Ost	Hire
AC09	Chair - Manual Recliner	No	1 Per Person	OT/Phys/RN/S/LMO/Ch/Ost	Hire
AC10	Replacement Parts and / or Repairs for AC Items	No	-	OT/Phys/RN/S/LMO/Ch/Ost	Buy
AD04	Urinals (With / Without Holder) (Male and Female)	No	-	OT/RN/CA/S/LMO/Physio	Buy
AE01	Back Supports	No	-	Phys/OT/Ch/Ost/RN/S/LMO	Buy
AE02	Bed Wedges and Supports	No	-	Phys/OT/RN/Ch/Ost/S/LMO	Buy
AE04	Pressure Care Cushion	No	-	OT/Phys/RN/Ch/Ost/S	Buy
AE06	Replacement Parts / Repairs for AE Items	No	-	OT/Phys/Ch/Ost/RN/S/LMO	Buy
AH01	Crockery and Cutlery - Adaptive	No	-	OT/RN/Phys/LMO/S	Buy
AH04	Book Holder	No	-	OT/ RN/Phys/LMO/S	Buy
AH06	Handle - Utensil	No	-	OT/RN/Phys/LMO/S	Buy
AH07	Jar Opener	No	-	OT/ RN/Phys/LMO/S	Buy
AH08	KeyTurner	No	-	OT/ RN/Phys/LMO/S	Buy
AH09	Non - Slip Table Mat	No	-	OT/ RN/Phys/LMO/S	Buy
AH11	Reaching Appliances	No	-	OT/ RN/Phys/LMO/S	Buy
AH12	Scissors - Spring Loaded Adaptive	No	-	OT/ RN/Phys/LMO/S	Buy
AH13	Tap Turner (See also AL04 Lever Taps)	No	-	OT/ RN/Phys/LMO/S	Buy
AH14	Tray Mobile - Height Adjustable	No	-	OT/ RN/Phys/LMO/S	Buy
AH15	Vegetable Board - Modified	No	-	OT/ RN/Phys/LMO/S	Buy
AH17	Eating / Kitchen / Household Adaptive Appliances - Miscellaneous Items	No	-	OT/ RN/Phys/LMO/S	Buy
AH18	Replacement Parts / Repairs for AH Items	No	-	OT/ RN/Phys/LMO/S	Buy
AH19	Shoe Horn - Long Handled	No	-	OT/ RN/Phys/LMO/S	Buy
AJ06	Footwear Temporary (Including Cast Boots / Shoes)	No	-	Pod/O/S/Phys/P/RN/LMO	Buy
AL04	Lever Taps	No	4 Outlets	OT/S	Buy
AL05	Lifts (Including Stair Lifts and Water Lifts)	Yes	1 Per Person	OT/S	Buy
AL06	Non-Slip Surfaces (Including Non-Slip Strips)	No	-	OT/Phys/RN/S	Buy
AL09	Rails (Internal and External)	No	-	OT/S	Buy
AL10	Ramps (Fixed)	Yes	-	OT/S	Buy
AL11	Ramps - Portable (Includes Folding or Retractable Aluminium / Fibreglass)	No	-	OT/S	Buy



# DVA: Ordering Guide

RAP Code	Category	Prior Approval Required	Veteran Limit	Eligible Prescriber	Hire or Buy
AL14	Step Modification	No	-	OT/S	Buy
AL15	Home Mods (Complex)	Yes	-	OT/S	Buy
AL16	Home Modifications – Minor – Labour Component	No	-	OT/S/RN/Physio/LMO	Buy
AL21	Home Mods (Minor)	No	-	OT/S	Buy
AL22	Replacement Parts / Repairs for AL Items	No	-	OT/S	Buy
AM01	Hoist / Personal Lifting Device (Includes Sling)	No	1 Per Person	Phys/OT/RN/S	Hire
AM02	Sling for Hoist - Additional	No	-	OT/Phys/RN/S	Buy
AM03	Replacement Parts / Repairs for AM Items	No	-	OT/Phys/RN/S	Buy
AP02	Electric Scooter Batteries	No	-	OT/S/LMO	Buy
AP03	Crutches	No	-	Phys/OT/Ch/Ost/LMO/S	Buy
AP05	Scooter - Electric	Yes	1 Per Person	OT/S/LMO	Hire
AP06	Quadstick / Quadrapod	No	-	Phys/OT/S/LMO	Buy
AP07	Knee Walker/Scooter	No	-	Physio/S/LMO	Buy
AP09	Transfer Equipment	No	-	Phys/OT/RN/S	Buy
AP12	Walking Frame (Includes Wheeled Walking Frame)	No	-	Phys/OT/Ch/Ost/S/LMO	Buy
AP13	Walking Stick	No	-	Phys/OT/Ch/Ost/S/LMO	Buy
AP14	Wheelchair Accessories	No	-	Phys/OT/Ch/Ost/S/LMO	Buy
AP15	Walking Stick Holder / Strap	No	-	Phys/OT/Ch/Ost/LMO/S/RN	Buy
AP16	Wheelchair - Electric - Power Drive	Yes	1 Per Person	OT/S/LMO	Hire
AP17	Wheelchair - Manual (Standard)	No	1 Per Person	Phys/OT/S/Ch/Ost/LMO	Hire
AP19	Wheelchair - Manual (Customised)	Yes	1 Per Person	Phys/OT/S/LMO	Hire
AP21	Replacement Parts / Repairs for AP Items	No	-	Phys/OT/S/Ch/Ost/LMO/RN	Buy
AP22	Walking Frame Accessories	No	8 Items / 5 per Year	Phys/OT/S/Ch/Ost/LMO/RN	Buy
AR01	Ankle Supports / Braces	No	3 Items / 1 Year	Phys/Pod/S/Ch/Ost O/P	Buy
AR02	Knee Supports / Braces	No	3 Items / 1 Year	Phys/S/Pod/Ch/Ost/O/P	Buy
AR03	Upper Limb Supports / Braces	No	6 Items / 1 Year	Phys/S/OT/P/O/Ch/Ost/LMO	Buy
AR04	Foot Orthoses / Orthotics	No	1 Pair / 1 Year	Pod/Phys/S/P/O/Ch/Ost/LMO	Buy
AR08	Lumbar Braces (Including Abdominal Binders)	No	2 Items / 1 Year	Phys/S/Ch/Ost/OT/P/O	Buy
AR09	Scrotal Support	No	4 Items / 1 Year	S/LMO/OT/Phys	Buy
AR14	Surgical Corsets (Including Belt/Truss)	No	4 Items / 1 Year	S/LMO/RN/OT/Phys/Ch/Ost	Buy
AR18	Cervical Collars	No	2 Items / 1 Year	Phys/S/Ch/Ost/LMO/P/O	Buy
AR19	Ankle Foot Orthoses (AFO)	No	2 Items / 1 Year	Phys/Pod/S/Ch/Ost/OT/P/O/LMO	Buy
AR22	Compression Garments	No	3 Pairs / 6 Months	S/RN/Phys/OT/LMO	Buy
AR23	Lymphoedema Pump	Yes	1 Per Person	S/RN/Phys/OT/LMO	Buy
AR26	Lymphoedema Garment Consumables (Glue / Adhesive /Spray)	No	-	S/RN/Phys/OT/LMO	Buy
AR27	Replacement Parts / Repairs for AR Items	No	-	Phys/S/Ch/Ost/OT/OST/LMO	-
AR28	Hip Protectors	No	6 Items / 1 Year + Shields	RN/Phys/S/OT/LMO	Buy
AR29	Limb Protectors	No	6 Items / 1 Year	RN/Phys/S/OT/LMO	Buy
AS01	Blood Pressure Monitor (Sphygmomanometer)	No	1 Item / 5 Years	S/LMO	Buy
AS16	Bracelet / Pendant – (Medical Info for Emergency)	No	-	LMO/S/RN	Buy
AS17	Replacement Parts and / or Repairs for AS Items	No	-	LMO/RN/OT/S	Buy
AT12	Drip Stand	No	-	LMO/S/RN/OT	Buy
AU01	Bottom Wiper	No	-	OT/LMO/RN/S/Phys	Buy
AU02	Button Hook	No	-	OT/LMO/RN/S/Phys	Buy
AU03	Denture Brush with Suction Cup	No	-	OT/LMO/RN/S/LDO/Phys	Buy
AU04	Dressing Stick	No	-	OT/LMO/RN/S/Phys	Buy
AU08	Long Handled Comb / Brush	No	-	OT/LMO/RN/S/Phys	Buy

# DVA: Ordering Guide

RAP Code	Category	Prior Approval Required	Veteran Limit	Eligible Prescriber	Hire or Buy
AU10	Long Handled Toe Wiper	No	-	OT/Pod/LMO/RN/S/Phys	Buy
AU13	Donning / Doffing Aids (i.e. For Socks, Stockings and Compression Garments)	No	-	OT/Pod/LMO/RN/S/Phys	Buy
AU14	Elastic Shoe Laces	No	-	OT/Pod/LMO/RN/S/Phys	Buy
AV01	Bicycle - Stationary Exercise	No	3 Months	Phys/S/Ch/Ost/EP	Hire
AV02	Pedals - Exercise	No	1 Per Person	Phys/S/Ch/Ost/EP	Buy
AV10	Exercise Appliances - Progressive Elastic Resistance / Hand Cone / Exercise Putty	No	-	Phys/S//Ch/Ost/EP	Buy
AV16	Replacement Parts and / or Repairs for AV Items	No	-	Phys/S/Ch/Ost/EP	Buy
AZ01	Bath Board / Bench / Seat	No	-	OT/RN/S	Buy
AZ02	Shower - Hand Held	No	-	OT/RN/S	Buy
AZ03	Shower Seat - Fold Down	No	-	OT/RN/S	Buy
AZ04	Shower Stool / Chair	No	-	OT/RN/S/Phys/LMO	Buy
AZ05	Replacement Parts and Repairs for AZ Items	No	-	OT/RN/S	Buy
AZ06	Waterproof Protectors for Limbs	No	-	OT/RN/S	Buy
AZ07	Bath Lift (Battery Operated)	Yes	-	OT/RN/S	Buy
BD03	TENS Machine	No	-	Phys/PC/Ch/Ost/S/LMO	Buy
BD04	TENS Machine Accessories	No	-	Phys/PC/Ch/Ost/RN/S/LMO	Buy
BE01	Bidet (Includes Electronic Model)	No	-	OT/RN/CA/S	Buy
BE02	Commode Chair - (Bedside)	No	-	OT/RN/CA/LMO	Buy
BE03	Commode Pan / Bed Pan / Slipper Pan	No	-	OT/RN/CA/S/LMO	Buy
BE04	Commode Shower Chair - Mobile	No	-	OT/RN/CA/S/Phys/LMO	Buy
BE06	Over Toilet Frame / Toilet Surround	No	-	OT/RN/CA/S/Phys/LMO	Buy
BE07	Porta Potty (Includes Frame and Solution for Continued Use)	No	-	OT/S/CA/RN/LMO	Buy
BE10	Toilet Seat - Raised	No	-	OT/RN/Phys/S	Buy
BE11	Replacement Parts and / or Repairs for BE Items	No	-	OT/RN/Phys/CA/S/LMO	Buy
BF01	Orientation Clock / Calendar	No	-	OT, LMO, RN, S, Physio	Buy
BF02	Orientation Signs	No	-	OT, LMO, RN, S, Physio	Buy
BF03	Coloured Toilet Seat	No	-	OT, LMO, RN, S, Physio	Buy
BF05	Locator Devices (Item Finder)	No	-	OT, LMO, RN, S, Physio	Buy
BF06	Medication Timers/Alerts	No	-	OT, LMO, RN, S, Physio	Buy
BF07	Memory Jogger	No	-	OT, LMO, RN, S, Physio	Buy
BF08	Sound and Movement Monitors	No	-	OT, LMO, RN, S, Physio	Buy
BF09	Exit Reminder	No	-	OT, LMO, RN, S, Physio	Buy
BF13	Replacement Parts and/or Repairs for BF items	No	-	LMO, RN, S, OT, Physio	Buy
BG01	Non-Slip Mat – Indoor and Outdoor rubber backed mats	No	-	OT, LMO, RN, S, Physio	Buy
BG02	Lighting – Sensor Light	No	-	OT, LMO, RN, S, Physio	Buy
BG03	Lighting – Other	No	-	OT, LMO, RN, S, Physio	Buy
BG04	Retractable Garden Hose	No	-	OT, LMO, RN, S, Physio	Buy
BG05	Clothes Handy Line	No	-	OT, LMO, RN, S, Physio	Buy
BG16	Falls Prevention - Labour Component	No	-	OT, LMO, RN, S, Physio	Buy

Key	
Ch	Chiropractor
S	Specialist (Includes All Medical Specialists in Relevant Field)
D	Dietician
LMO	Local Medical Officer (Or Other GP)
LDO	Local Dental Officer (Or Dentist)
O	Orthotist
Ost	Osteopath
OT	Occupational Therapist

Key	
Physio	Physiotherapist
Pod	Podiatrist
P	Prosthetist
RN	Registered Nurse
EP	Exercise Physiologists
PC	Pain Clinic
CA	Continence Adviser (RN or Physiotherapist Continence Adviser)

## General Enquiries

P 1300 133 120 | E sales@aidacare.com.au | W www.aidacare.com.au

# Complex Rehab

Bringing Simplicity to Complexity

Customised seating and mobility solutions

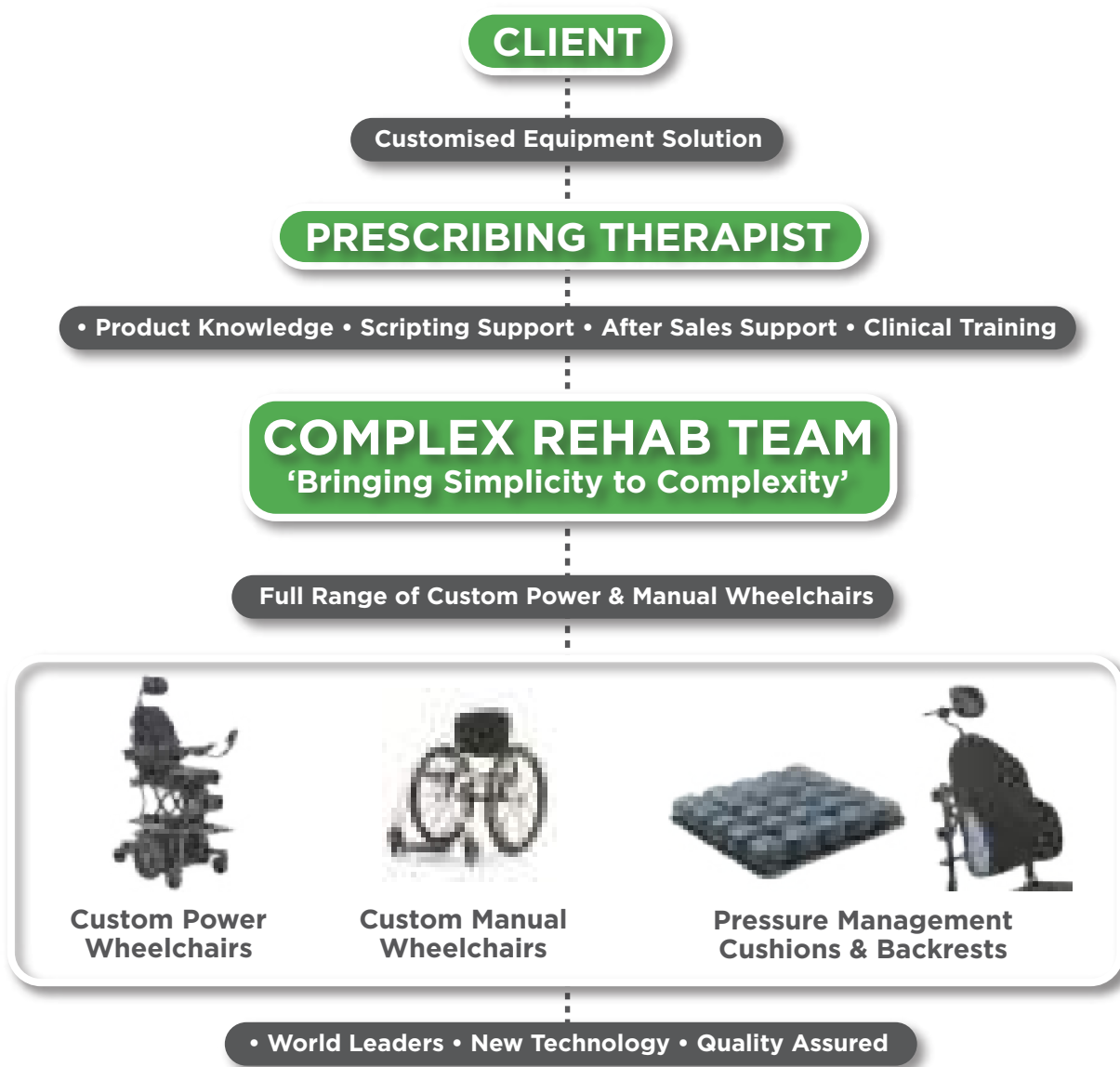

Mobility Wheelchairs & Positioning  
Solutions Refer to Page 271



Our team of expert installers are on hand to meet your every need

- Shower, Toilet & Bathroom Modifications
- Access Ramps
- Grab Rails For Bathrooms / Toilets
- Handheld Showers
- All modifications comply with the highest industry standards
- Emergency cases can be completed as soon as next day

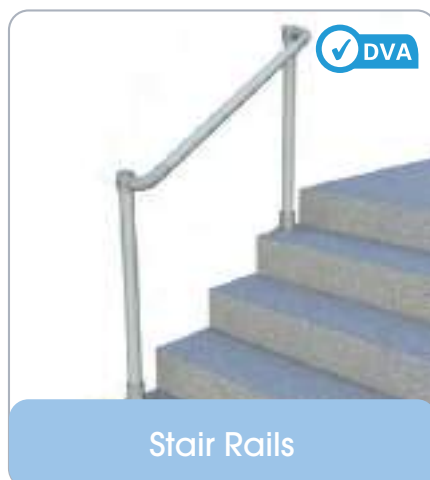
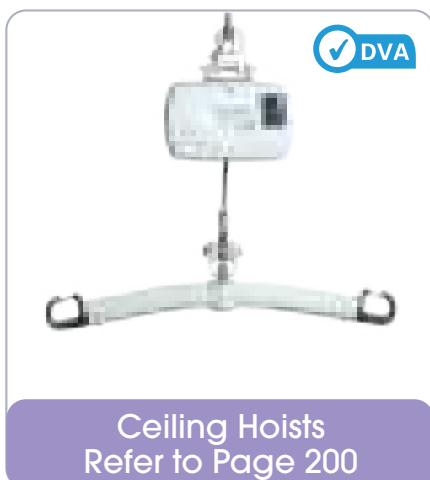
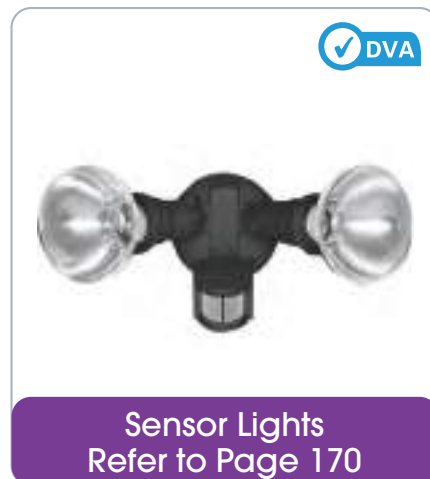
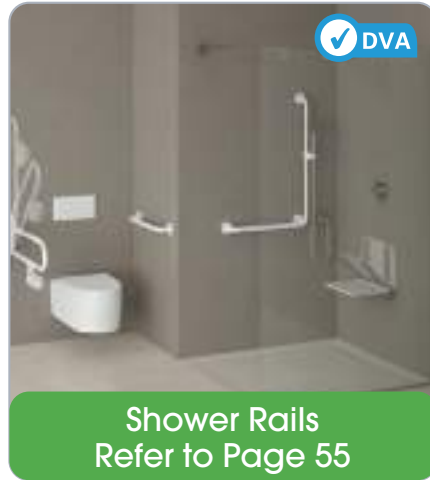

Call us for an obligation free quote today  
**1300 133 120**



Look for this icon throughout the catalogue for products that can be modified for the home!

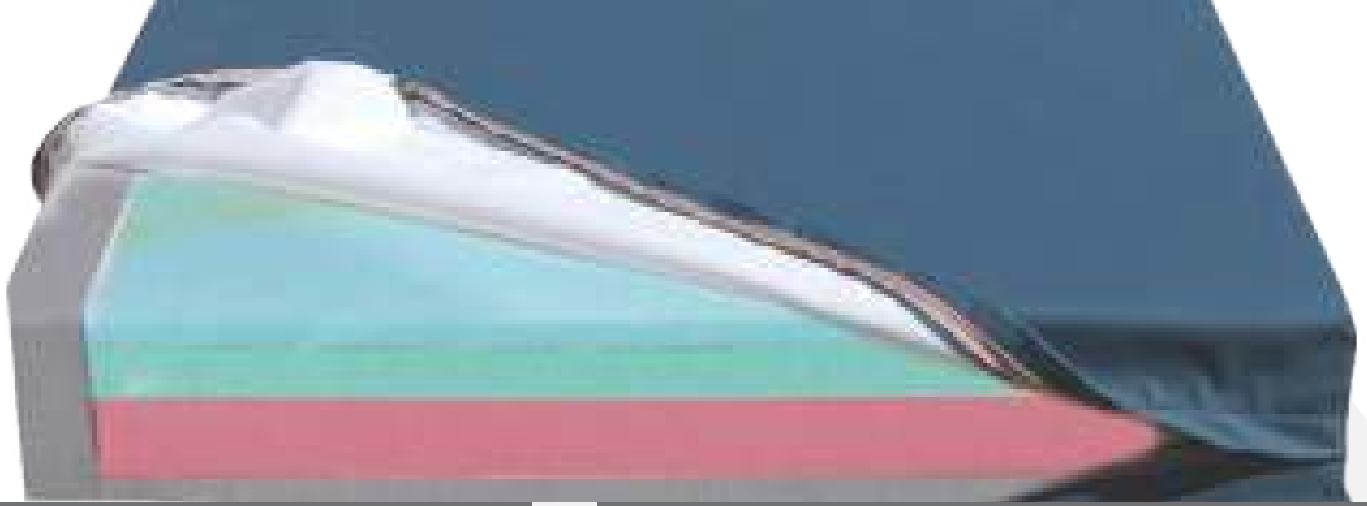

# Bariatric

# Contents

- P 014 What is Bariatric Equipment?
- P 014 Bathroom & Toilet
- P 015 Bedroom
- P 015 Chairs - Therapeutic
- P 016 Cushions & Seating
- P 016 Manual Handling - Lifters & Slings
- P 016 Mobility Scooters
- P 017 Mobility Ramps
- P 017 Mobility Walking Frames & Aids
- P 017 Mobility Wheelchairs & Positioning
- P 017 Hospital & Ward Equipment





## What is Bariatric Equipment?

Bariatric equipment is becoming ever more prevalent in the healthcare market but what is bariatrics and what is bariatric equipment?

Bariatrics deals with causation, the prevention and also the treatment of obesity in our community. With the current rise of obesity in our population, equipment needs have changed and there has been a demand to provide equipment in different configurations to meet these needs.

Aidacare in conjunction with AusBIG\* state that a Bariatric client may have one or more of the following characteristics:

- Weight Capacity > 125 kg
- Body Mass Index (BMI\*\*) > 30
- Seat Width > 20" (50cm)

If one or more of these characteristics are present or anything else that is relevant, then an assessment of the client is required by their health professional. There are many variations to these characteristics but recognising the need to provide suitable equipment for Bariatric clients is paramount to the safety of the client as well the family, carers and health professionals.

Bariatric equipment is designed to assist in:

- Pressure management for the client
- Heat management for the client
- Effective weight distribution on the seating surface



Bariatric equipment is identified throughout the catalogue by the use of this symbol.

Aidacare's Bariatric equipment range has been developed with our suppliers to ensure our range includes larger seat widths, increased weight capacities and reinforced construction materials to meet the specific needs of the user.

\* AusBig (Australian Bariatric Innovations Group) Their aim is to raise the awareness of the complexity of safe and dignified management of the bariatric patient. [www.ausbig.com.au](http://www.ausbig.com.au)

\*\* BMI is defined as the weight in kilograms divided by the square of the height in metres (kg/m squared).

$$\text{BMI} = \text{weight (kg)} / \text{height (m)} \times \text{height (m)}$$

The classification of overweight and obesity, according to BMI, is shown in the table below. This applies to men and women over the age of 18.

Classification	Underweight	Normal Range	Overweight	Obese
BMI	Below 18.5	18.5 - 24.9	25.0 - 29.9	> 30

The following is an overview of the Bariatric equipment to be found in this catalogue together with the relevant reference page for full product details.

**I ♥ ndis** For NDIS Item Code, refer to page: 508

### Bathroom & Toilet



400 kg

Aspire 600mm Weight Bearing Platform Commode  
(Refer to Page 21)



200 kg

Aspire 530mm Weight Bearing Platform Commode  
(Refer to Page 20)



200 kg

Aspire 600mm Swing Away Footrest Commode  
(Refer to Page 21)

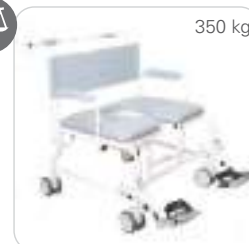

350 kg

Aspire Bariatric Shower Commode  
(Refer to Page 23)



250 kg

Aspire 530mm TIS Shower Commode  
(Refer to Page 22)

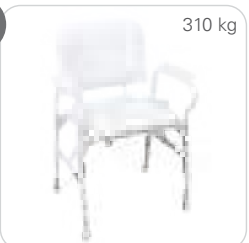

310 kg

Aspire MAXI Shower Chair  
(Refer to Page 33)

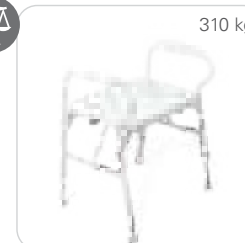

310 kg

Aspire MAXI Shower Stool  
(Refer to Page 36)

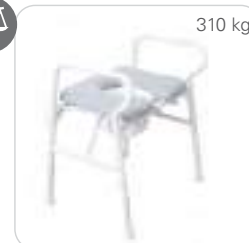

310 kg

Aspire MAXI Over Toilet Aid  
(Refer to Page 39)

### General Enquiries

P 1300 133 120 | E [sales@aidacare.com.au](mailto:sales@aidacare.com.au) | W [www.aidacare.com.au](http://www.aidacare.com.au)



227 kg

Shower Stool Maxi Compact  
(Refer to Page 37)



175 kg

Aspire Toilet Surround  
(Refer to Page 40)



200 kg

Aspire Raised Toilet Seat  
(Refer to Page 41)



227 kg

Bath Transfer Bench Bariatric  
(Refer to Page 45)

## Bedroom



Unlimited kg

ROHO® Mattress Section  
(Refer to Page 74)



210 kg

Bedside Commode Maxi  
Fixed Height  
(Refer to Page 79)

## Chairs - Therapeutic



200 kg

Aspire Waterfall Chair  
(Refer to Page 110)

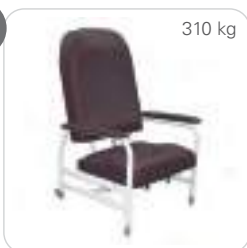

310 kg

Aspire MAXI Day Chair  
(Refer to Page 113)



210 kg

Maxi Low Back Day Chair  
(Refer to Page 113)

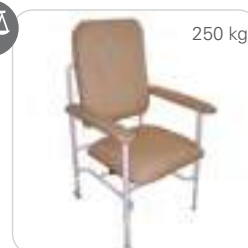

250 kg

Maxi High Back Day Chair  
(Refer to Page 113)



145 kg

Aspire Signature Lift Recline  
Chair - Space Saver  
(Refer to Page 114)



155 kg

Aspire Signature Lift Recline  
Chair - Dual Action  
(Refer to Page 115)



220 kg

Aspire Montana Lift Recline  
Chair  
(Refer to Page 116)



227 kg

LC-358XL Powerlift Chair  
(Refer to Page 117)



180 kg

Aspire Mobile Air Chair - Large  
(Refer to Page 119)



300 kg

Deluxe Bed MAXI - Electric  
(Refer to Page 120)

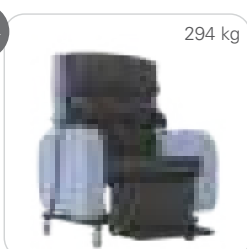

294 kg

Sorrento Bariatric Chair  
(Refer to Page 122)



## Cushions & Seating



Unlimited kg



Action Gel Pad  
(Refer to Page 133)



Unlimited kg



ROHO Quadtro Select  
(Refer to Page 139)



Unlimited kg



ROHO Single Compartment  
(Refer to Page 141)



Unlimited kg



ROHO Dual Compartment  
(Refer to Page 141)



295 kg



J2 Plus Bariatric  
(Refer to Page 149)



230 kg



JAY J3 Air Cushion  
(Refer to Page 150)



294 kg



Spectrum Foam SPP  
(Refer to Page 151)



250 kg



Cloud Cushion  
(Refer to Page 152)

## Manual Handling - Lifters & Slings



205 kg



Aidacare Aspire A205  
(Refer to Page 187)



320 kg



Aidacare Aspire A320  
(Refer to Page 188)



300 kg



Aidacare Aspire Slings  
(Refer to Page 190)



300 kg



Liko Viking XL Lifter  
(Refer to Page 195)

## Mobility Scooters



159 kg



Pathrider 130 XL Pursuit  
(Refer to Page 227)



181 kg



Victory 10 LX  
(Refer to Page 227)



181 kg



Pathrider 140 XL  
(Refer to Page 227)



181 kg



Celebrity Deluxe XL  
(Refer to Page 229)

## Mobility Ramps



400 kg

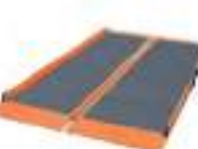

Aspire Public Transport  
Ramps (Refer to Page 235)



272 kg



Silver Star Ramps  
(Refer to Page 235)



300 kg



Edge Barrier Limited Ramps  
(Refer to Page 236)



300 kg



Threshold Ramps  
(Refer to Page 236)

## General Enquiries

P 1300 133 120 | E sales@aidacare.com.au | W www.aidacare.com.au





Mobility Walking  
Frames & Aids



180 kg

Aspire Seat Walker XL  
(Refer to Page 258)



300 kg

Maxicare Walker  
(Refer to Page 261)



180 kg

Aspire Walking Tutor HD  
(Refer to Page 265)

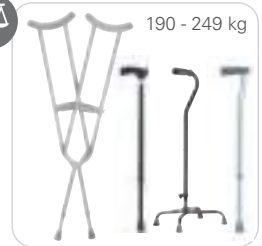

190 - 249 kg

Bariatric Crutches &  
Walking Sticks  
(Refer to Page 268)

Mobility Wheelchairs &  
Positioning



180 kg

Aspire Evoke 2 HD  
(Refer to Page 273)

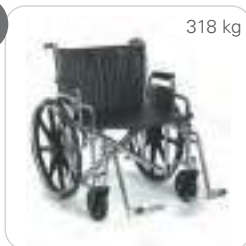

318 kg

Super HD Wheelchair  
(Refer to Page 284)

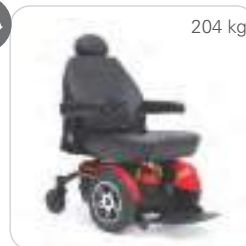

204 kg

Jazzy Select Elite HD  
(Refer to Page 287)

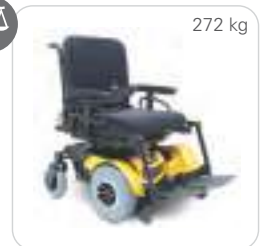

272 kg

Quantum Q1450  
(Refer to Page 292)

Hospital & Ward  
Equipment



400 kg

Malvestio Botero Bariatric  
Ward Bed  
(Refer to Page 321)



230 kg

Aspire Lifecomfort Hybrid  
Acute Mattress System  
(Refer to Page 323)



300 kg

Aspire Lifecomfort Bariatric  
(Refer to Page 323)



450 kg

Aspire Lifecomfort Active Bari  
10 Alternating Mattress  
Replacement  
(Refer to Page 324)



250 kg

Aspire Lifecomfort Active Air  
Acute 8 Alternating Mattress  
Replacement (Refer to Page 324)



260 kg

Malvestio ONEday Electric  
Hospital Stretcher  
(Refer to Page 330)



220 kg

Aspire Boboath  
Therapy Couch  
(Refer to Page 331)



300 kg

Greiner Multiline XXL  
Bariatric Treatment Chair  
(Refer to Page 336)

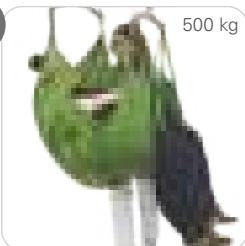

500 kg

Liko UltraSling Bariatric Sling  
(Refer to Page 348)



363 kg

LikoGuard XL Fixed Ceiling Hoist  
(Refer to Page 351)



300 kg

Wheelchair Scale  
(Refer to Page 362)



250 kg

Colonial Weigh Chair  
(Refer to Page 362)

DVA Contact Details

P 1300 888 052 | F 1300 787 052 | E [dva@aidacare.com.au](mailto:dva@aidacare.com.au)



For NDIS Item Code,  
refer to page: 508

CONTACT US  
FOR A BROCHURE



# BATHROOM RANGE

Shower Chair

Shower Commode

Over Toilet Aid



aspire for.....

safety

comfort

support



[www.aspirecare.com.au](http://www.aspirecare.com.au)  
1300 133 120



## Bathroom & Toilet

## Contents

- P 020 Aspire Shower Commodes
- P 027 Verto Shower Commodes
- P 028 Aquatec Shower Commodes
- P 029 K Care Shower Commodes
- P 032 Shower Seating
- P 038 Toileting Aids
- P 041 Other Toileting Aids
- P 044 Transfer Aids
- P 047 Other Bathing
- P 051 Bathroom Trolleys
- P 053 Bed Pans, Urinals & Bowls
- P 055 Grab Rails



# Shower Commodes



For NDIS Item Code, refer to page: 508



Brochures also available. Please contact us for a copy.

## Aspire Weight Bearing Platform Commode - 460/530mm



Open Armrests Style Accommodates a Wider Sitting Surface whilst Maintaining a Smaller Base Footprint for Improved Accessibility

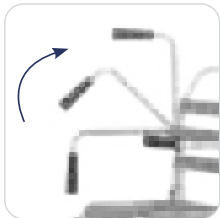

Easy-Slide Weight Bearing Platform Footrest Slides Completely Away for Transfers

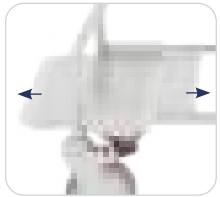

Self Propelled Model

4x Total Locking Stainless Steel Castors Provide Brake Access from All Angles

8° Backrest Angle Ensures Patient Comfort

Safety Arms Prevent Falls and Swing Back out of the way for Transfers

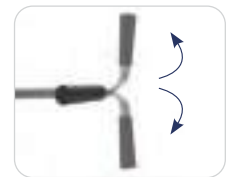

Integrated Access Trough Improves Hygiene whilst Maintaining Toilet Bowl Clearance Height of 465mm



\*Seat Sold Separately



Components



Corrosion



Code	Description	Overall Height	Overall Width	Seat Width	Backrest Height	Armrest Height	Anterior Seat Height	Posterior Seat Height	DVA:
BTC066000	WB Platform - 460mm - Att Prop - S/Steel	995 mm	535 mm	460 mm	305 mm	225 mm	590 mm	560 mm	BE04
BTC066200	WB Platform - 460mm - Self Prop - S/Steel	995 mm	665 mm	460 mm	305 mm	225 mm	590 mm	560 mm	BE04
BTC066050	WB Platform - 530mm - Att Prop - S/Steel	995 mm	605 mm	530 mm	305 mm	225 mm	590 mm	560 mm	BE04
BTC066055	WB Platform - 530mm - Self Propelled - S/Steel	995 mm	735 mm	530 mm	305 mm	225 mm	590 mm	560 mm	BE04

### General Enquiries

P 1300 133 120 | E sales@aidacare.com.au | W www.aidacare.com.au



## Aspire Weight Bearing Platform Commode - 600mm (400kg Capacity)



Height Adjustable Reinforced Armrests Offer Drop Flat Positioning to Assist with Lateral Slide Transfers

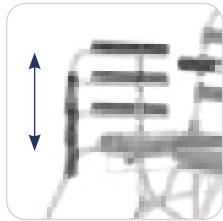

Easy-Slide Weight Bearing Platform Footrest Slides Completely Away for Transfers



Heavy Duty Reinforced Wide Frame can Support Bariatric Users up to 400kg

4x Total Locking Stainless Steel Castors Provide Brake Access from All Angles



\*Seat Sold Separately



Components

Corrosion

Code	Description	Overall Height	Overall Width	Seat Width	Backrest Height	Armrest Height	Anterior Seat Height	Posterior Seat Height	DVA:
BTC061400	WB Platform - 600mm - Att Prop - S/Steel	995 mm	725 mm	600 mm	300 mm	290 mm	590 mm	560 mm	BE04

## Aspire Swing Away Footrest Commode - 460/530/600mm



Ultra Low Seat Height of 590mm which can be Reduced to 490mm when Customised

Open Armrests Style Accommodates a Wider Sitting Surface Whilst Maintaining a Smaller Base Footprint for Improved Accessibility

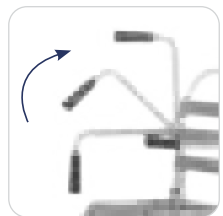

Height Adjustable, Swing Away Footrests for Optimal Positioning and Ease of Transfers



Self Propelled Model



Angle Adjustable Backrest from 8° To 18° for Improved Seating Comfort

Safety Arms Prevent Falls and Swing Back out of the way for Transfers

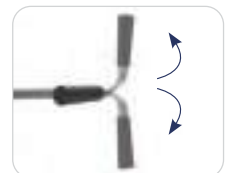

Integrated Access Trough Improves Hygiene Whilst Maintaining Toilet Bowl Clearance Height of 465mm



\*Seat Sold Separately



Components

Corrosion

2 x total lock stainless steel castors and 2 x large rear push wheels for self-propelling

Code	Description	Overall Height	Overall Width	Seat Width	Backrest Height	Armrest Height	Anterior Seat Height	Posterior Seat Height	DVA:
BTC065900	Swing Away - 460mm - Att Prop - S/Steel	895 - 995 mm	535 mm	460 mm	305 mm	225 mm	590 mm	560 mm	BE04
BTC066100	Swing Away - 460mm - Self Prop - S/Steel	895 - 995 mm	665 mm	460 mm	305 mm	225 mm	590 mm	560 mm	BE04
BTC066060	Swing Away - 530mm - Att Prop - S/Steel	995 mm	605 mm	530mm	305 mm	225 mm	590 mm	560 mm	BE04
BTC066065	Swing Away - 530mm - Self Prop - S/Steel	995 mm	735 mm	530 mm	305 mm	225 mm	590 mm	560 mm	BE04
BTC061300	Swing Away - 600mm - Att Prop - S/Steel	995 mm	675 mm	600 mm	305 mm	225 mm	590 mm	560 mm	BE04
BTC061305	Swing Away - 600mm - Self Prop - S/Steel	995 mm	805 mm	600 mm	305 mm	225 mm	590 mm	560 mm	BE04

### DVA Contact Details

P 1300 888 052 | F 1300 787 052 | E dva@aidacare.com.au



For NDIS Item Code, refer to page: 508





## Aspire Tilt & Recline Shower Commode - 460/530mm



Backrest may be Configured as Full Length or 3/4 Length With the Top 1/4 Section Removable.

Open Back Straps Provide Greater Access for Bathing Needs

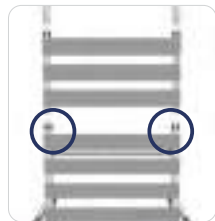

35° of Gas-assisted Tilt-in-space Functionality Minimises Manual Handling Efforts During the Showering Process



Height Adjustable, Swing Away Footrests for Optimal Positioning and Ease of Transfers

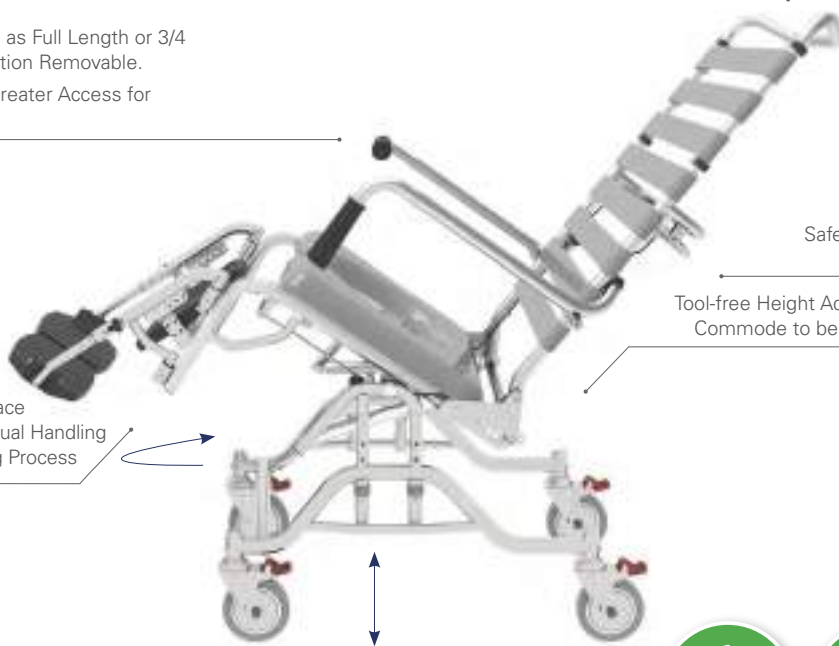

4 Lockable Stainless Steel Castors Maximise Safety by Providing Carer Access to a Brake at all Angles Around the Commode

30° of Backrest Angle Adjustment in 10° Increments for Effortless Repositioning and Maximum User Comfort



Safety Arms Prevent Falls and Swing Back out of the way for Transfers

Tool-free Height Adjustment to 4 Settings Allow the Commode to be Easily Adapted to Varying Needs

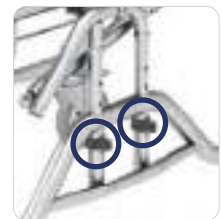

\*Seat Sold Separately



Components

Corrosion

Code	Description	Overall Height	Overall Width	Seat Width	Backrest Height	Armrest Height	Anterior Seat Height	Posterior Seat Height	DVA:
BTC066030	460mm - Attendant Propelled	1315 - 1485 mm	560 mm	460 mm	900 mm	275 mm	460 - 630 mm	460 - 620 mm	BE04
BTC066040	530mm - Attendant Propelled	1315 - 1485 mm	630 mm	530 mm	900 mm	275 mm	460 - 630 mm	460 - 620 mm	BE04

## Aspire Aluminium Commode - 440mm



- Height adjustable shower commode to accommodate all different types of users
- Powder coated aluminium finish
- Swing back arms as standard
- Swing away footrests
- 2 x locking castors
- Soft opening PU seat
- Available in self propelled and attendant propelled versions



Components

Corrosion

Code	Description	Overall Height	Overall Width	Seat Width	Backrest Height	Armrest Height	Anterior Seat Height	Posterior Seat Height	DVA:
BTC068010	Aluminium Shower Commode - Attendant Propelled	989 - 1039 mm	460 mm	440 mm	495 mm	220 mm	525 - 580 mm	525 - 580 mm	BE04
BTC068020	Aluminium Shower Commode - Self Propelled	969 - 994 mm	610 mm	440 mm	490 mm	235 mm	525 - 570 mm	525 - 570 mm	BE04



## Aspire Bariatric Shower Commode

Super Heavy Duty Bariatric Design with  
790mm Seat and 350kg SWL

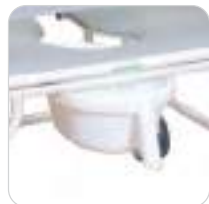

Comes Standard with Pan and Carrier

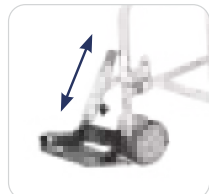
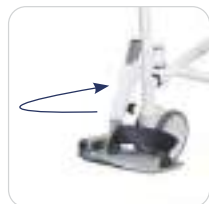

Height Adjustable, Swing Away Footrests for  
Optimal Positioning And Ease of Transfers



Removable Arms to Assist with Positioning  
and Allow Lateral Slide Transfers

Padded Seat and Arms for  
Maximum Comfort

Anti-Bacterial Frame Coating for  
Improved Infection Control

4x Lockable Castors Maximise Safety by Providing  
Carer Access to a Brake at all Angles around the Commode



Components



Corrosion



Code	Description	Overall Height	Overall Width	Seat Width	Backrest Height	Armrest Height	Anterior Seat Height	Posterior Seat Height	DVA:
BTC061200	Bariatric Shower Commode	990 mm	900 mm	790 mm	430 mm	170 mm	570 mm	570 mm	BE04

## Aspire Shower Commode Seats and Accessories



### Aspire Open Seat

- Moulded and seamless soft PU seats designed for comfort and durability
- Easy clean, fully sealed surface for infection control
- Choose the size appropriately to fit your Aspire Shower Commode
- Adaptable to most shower commode brands



Code	Description	Width	Warranty	DVA:
BTC066600	Open Seat	460 mm	1 Year	BE11
BTC066750	Open Seat	530 mm	1 Year	BE11
BTC066800	Open Seat	600 mm	1 Year	BE11



### Aspire Closed Seat

- Moulded and seamless soft PU seats designed for comfort and durability
- Easy clean, fully sealed surface for infection control
- Choose the size appropriately to fit your Aspire Shower Commode
- Adaptable to most shower commode brands



Code	Description	Width	Warranty	DVA:
BTC066700	Closed Seat	460 mm	1 Year	BE11

### DVA Contact Details

P 1300 888 052 | F 1300 787 052 | E [dva@aidacare.com.au](mailto:dva@aidacare.com.au)



For NDIS Item Code,  
refer to page: 508





## Aspire Hand Made Pressure Reducing Seat

- Hand made pressure care seat surface designed for comfort during extended use and pressure injury prevention
- European Dartex anti-microbial four-way stretch fabric is waterproof and breathable
- Multi-layered foam, with memory foam top layer, to maximise immersion and envelopment for pressure distribution
- Sealed seams for infection control management
- Adaptable seat attachment to suit all shower commode brands
- Max seat height: 65mm
- Fully customisable options to suit specific needs



Code	Description	Width	Warranty	DVA:
BTC089122	Pressure Reducing - Open Front	320 mm	1 Year	BE11
BTC089124	Pressure Reducing - Closed Front	320 mm	1 Year	BE11
BTC089126	Pressure Reducing - Open Front	400 mm	1 Year	BE11
BTC089128	Pressure Reducing - Closed Front	400 mm	1 Year	BE11
BTC089130	Pressure Reducing - Open Front	460 mm	1 Year	BE11
BTC089140	Pressure Reducing - Closed Front	460 mm	1 Year	BE11
BTC089150	Pressure Reducing - Open Left	460 mm	1 Year	BE11
BTC089160	Pressure Reducing - Open Right	460 mm	1 Year	BE11
BTC089170	Pressure Reducing - Open Front	500 mm	1 Year	BE11
BTC089180	Pressure Reducing - Closed Front	500 mm	1 Year	BE11
BTC089190	Pressure Reducing - Open Front	550 mm	1 Year	BE11
BTC089200	Pressure Reducing - Closed Front	550 mm	1 Year	BE11
BTC089210	Pressure Reducing - Open Front	600 mm	1 Year	BE11
BTC089220	Pressure Reducing - Closed Front	600 mm	1 Year	BE11
BTC089230	Pressure Reducing - Open Front	650 mm	1 Year	BE11
BTC089240	Pressure Reducing - Closed Front	650 mm	1 Year	BE11

Code	Description	Warranty	DVA:
BTC089250	Pressure Reducing - Customised	1 Year	BE11

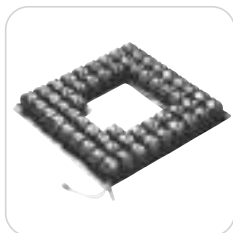

## ROHO® Padded Seats

- High level pressure relief
- Interconnected air cells help disperse pressure
- Includes cover
- Fully washable

Code	Description
BTC067500	Closed Seat - 380 mm x 425 mm
BTC067900	Closed Seat - 425 mm x 425 mm
BTC067600	Closed Seat - 425 mm x 470 mm
BTC067300	Closed Seat - 470 mm x 470 mm



## Aspire Self Propelling Conversion Kit

Converts Attendant Propelled Shower Commodes into Self Propelling version.

### Self propelling kit includes:

- 22" solid wheels with black spokes and push rims
- Quick release axles and mounting hardware
- Anti-tippers with roller wheels
- Clamp-on hand brakes

\* Not compatible with Bariatric (BTC061200, BTC061400), Tilt & Recline (BTC066030, BTC066040) or Aluminium Shower Commodes (BTC068010, BTC068020).



Code	Description	Warranty	DVA:
BTC082900	Self Propelling Conversion Kit	1 Year	BE11





## Aspire Oxygen Bottle Carrier

- 140mm diameter stainless steel holder suits sizes Oxygen Bottle sizes C to D
- Adaptable clamp fits most shower commode brands



Code	Description	Warranty	DVA:
BTC067200	Oxygen Bottle Carrier	1 Year	BE11



## Aspire Commode Bowl & Pan Carrier

- Stainless steel, slides easily under seat
- Carries a commode bowl with lid, or standard size bed pan



Compatible with Bowl (BTC081610) or Pan (BTT151800)

Code	Description	DVA:
BTC066400	Pan Carrier - 460mm - 600mm	BE11



## Aspire Commode Bowl

- Assists in the collection of waste
- Bowl washable to 95°C



Code	Description	Warranty	DVA:
BTC081610	Commode bowl w/lid & handle	1 Year	BE03



## Aspire Bed Pan

- Assists in the collection of waste
- Bed pan autoclavable



Code	Description	Warranty	DVA:
BTT151800	Bed Pan	1 Year	BE03



## Aspire Adjustable Pelvic Belt

- Adjustable belt to assist with pelvic and lower thoracic positioning and safety.
- Durable and washable to 95°C
- Plastic buckle reduces chill when in contact with users skin



Code	Description	Warranty	DVA:
BTC067100	Adjustable Pelvic Strap	1 Year	BE11

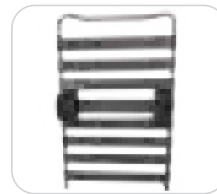

## Aspire Lateral Supports

- Width and height adjustable thoracic positioning and lumbar spine support
- Adaptable clamp also fits other shower commode brands



\*Not compatible with BTC061200, BTC068010 & BTC068020

Code	Description	Warranty	DVA:
WCA867010	Lateral Supports	1 Year	BE11



## Aspire Advanced Headrest

- Height and depth adjustable padded headrest for head and neck positioning and support
- Adaptable to other brands



\*Not compatible with BTC061200, BTC068010 & BTC068020

Code	Description	Warranty	DVA:
BTC067050	Advanced Headrest	1 Year	BE11



## Legrest with Calfpad

- Assists in leg and foot positioning or elevation, most commonly to treat oedema



Code	Description	Warranty
GSP342419	Legrest with Calfpad - Left	1 Year
GSP342420	Legrest with Calfpad - Right	1 Year



## Aspire Stump Support

- Adjustable support for amputees
- Adaptable clamp fits most shower commode brands



\*Not compatible with BTC061200, BTC068010 & BTC068020

Code	Description	Warranty	DVA:
BTC067105	Stump Support	1 Year	BE11

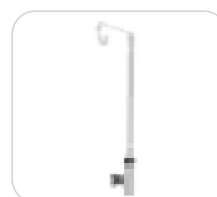

## Aspire Adjustable IV Pole

- Clamp-on stainless steel pole to organise intravenous equipment
- Height adjustable
- Adaptable clamp fits most shower commode brands



Code	Description	Warranty	DVA:
BTC067103	Adjustable IV Pole	1 Year	BE11



## Aspire Elevating Legrests

- Assists in leg and foot positioning or elevation, most commonly to treat oedema
- Angle adjustable to six positions

- Fits all Aspire Shower Commodes with swing away legrests
- Footplate is height and angle adjustable



Code	Description	Warranty	DVA:
BTC067110	Elevating Legrest - Left	1 Year	BE11
BTC067115	Elevating Legrest - Right	1 Year	BE11



Bathroom & Toilet

Aspire Shower Commodes Accessories Matrix			Accessories Fit Commode Code(s)															
Retrofit (can be easily fitted to commode)		DVA:	BTC066000	BTC066200	BTC066050	BTC066055	BTC061400	BTC065900	BTC066100	BTC066060	BTC066065	BTC061300	BTC061305	BTC066030	BTC066040	BTC061200	BTC068010	BTC068020
Code	Equipment Description		WB Platform					Swing Away Footrests					Tilt & Recline		Bariatric	Aluminium		
			BE04	BE04	BE04	BE04	BE04	BE04	BE04	BE04	BE04	BE04	BE04	BE04	BE04	BE04	BE04	BE04
<b>Padded Seats</b>																		
BTC066600	460mm Open	BE11																
BTC066700	460mm Closed	BE11																
BTC066750	530mm Open	BE11																
BTC066800	600mm Open	BE11																
<b>Hand Made Pressure Seat - Customisation Available</b>																		
BTC089122	320mm Open Front	BE11	* For K-Care Items															
BTC089124	320mm Closed Front	BE11																
BTC089126	400mm Open Front	BE11																
BTC089128	400mm Closed Front	BE11																
BTC089130	460mm Open Front	BE11																
BTC089140	460mm Closed Front	BE11																
BTC089150	460mm Open Left	BE11																
BTC089160	460mm Open Right	BE11																
BTC089170	500mm Open Front	BE11																
BTC089180	500mm Closed Front	BE11																
BTC089190	550mm Open Front	BE11																
BTC089200	550mm Closed Front	BE11																
BTC089210	600mm Open Front	BE11																
BTC089220	600mm Closed Front	BE11																
BTC089230	650mm Open Front	BE11																
BTC089240	650mm Closed Front	BE11																
<b>ROHO Padded Seat - Additional Accessory for Seats</b>																		
BTC067500	425mm Closed	-																
BTC067900	425mm Closed	-																
BTC067600	470mm Closed	-																
BTC067300	470mm Closed	-																
<b>Other Accessories</b>																		
BTC082900	Self Propelling Kit	BE11																
BTC066400	Pan Carrier	BE11																
BTC081610	Commode Bowl	BE03																
BTT151800	Bed Pan	BE03																
BTC067110	Elevating Leg Rest - L	BE11																
BTC067115	Elevating Leg Rest - R	BE11																
BTC067105	Stump Support	BE11																
BTC067050	Advanced Head Rest	BE11																
WCA867010	Lateral Support	BE11																
BTC067200	Oxygen Bottle Carrier	BE11																
BTC067100	Adjustable Pelvic Strap	BE11																
BTC067103	Adjustable IV Pole	BE11																
GSP342419	Legrest with Calfpad - Left	-																
GSP342420	Legrest with Calfpad - Right	-																

**General Enquiries**

P 1300 133 120 | E sales@aidacare.com.au | W www.aidacare.com.au



## Verto Height Adjustable Shower Commode - Attendant Propelled

- Adjustable seat height in increments of 25mm
- Depth and height adjustable polyurethane backrest which is removable for cleaning purposes
- Robust, lightweight stainless steel construction
- Height adjustable swing-away legrests
- Height adjustable armrests
- 5 year warranty
- \*Seat Sold Separately*



Self Propelled Model

Code	Description	Seat Width	Seat Height	Overall Width	Backrest Height	S.W.L	DVA:
BTC069490	Swing Away - 475mm - Att Prop	475 mm	495 - 620 mm	545 mm	485 mm	180 kg	BE04
BTC069450	Swing Away - 550mm - Att Prop	550 mm	520 - 645 mm	645 mm	485 mm	180 kg	-
BTC069480	Swing Away - 475mm - Self Prop	475 mm	495 - 620 mm	660 mm	485 mm	180 kg	BE04
BTC069460	Swing Away - 550mm - Self Prop	550 mm	520 - 645 mm	790 mm	485 mm	180 kg	-
BTC069505	Shower Commode Bedpan and Bowl Carrier						



## Verto Height Adjustable Shower Commode - Attendant Propelled

- Adjustable seat height in increments of 25mm
- Depth and height adjustable polyurethane backrest which is removable for cleaning purposes
- Weight bearing footplate
- Robust, lightweight stainless steel construction
- Height adjustable swing-away legrests
- Height adjustable armrests
- 5 year warranty
- \*Seat Sold Separately*

Code	Description	Seat Width	Seat Height	Overall Width	Backrest Height	S.W.L
BTC069495	WB Platform - 475 mm - Att Prop	475 mm	500 - 625 mm	550 mm	485 mm	180 kg
BTC069505	Shower Commode Bedpan and Bowl Carrier					



## Tilt in Space Shower Commode

- Gas assisted tilt in space design
- Polyurethane backrest which is removable for cleaning purposes
- Robust, lightweight stainless steel construction
- Padded swing away armrests
- Height adjustable swing-away legrests with calf padding
- Height adjustable armrests
- 5 year warranty
- \* Seat Sold Separately*



Bedpan and Bowl Carrier

Code	Description	Seat Width	Seat Height	Overall Width	Backrest Height	S.W.L	DVA:
BTC069500	Tilt in Space Shower Commode	545 mm	590 mm	545 mm	900 mm	183 kg	BE04



## TIS Electric Tilt - 600mm - Attendant Propelled

- Handmade padded backrest & seat
- Padded swing away armrests
- Swing away, height adjustable and ergonomic swivel foot plate
- Polyurethane swivel calf pads
- "Clip on" seat can be easily removed for cleaning
- 125mm diameter maintenance free braking swivel castors
- Plastic pan runners
- Water resistant IP65 electric actuators for a smooth and effortless tilt action
- Robust design, manufactured from durable 304 stainless steel
- Handset controller for freedom to operate around the commode
- Multi positional padded headrest
- \* Headrest Sold Separately*

Code	Description	Seat Width	Seat Height	Overall Width	Backrest Height	Tilt Angle	S.W.L
BTC069505	TIS Electric Tilt - 600 mm - Att Prop	600 mm	590 mm	700 mm	630 mm	10° - 35°	225 kg

## Verto Shower Commode Seat Options All seats below are compatible with the Verto Shower Commode Range



Polyurethane - Closed Front  
- Width 470mm  
BTC069520

Polyurethane - Open Front  
- Width 470mm  
BTC069510



Pressure Reducing Seat - Open  
- Width 460mm  
BTC089131

Pressure Reducing Seat - Closed  
- Width 460mm  
BTC089130

### DVA Contact Details

P 1300 888 052 | F 1300 787 052 | E [dva@aidacare.com.au](mailto:dva@aidacare.com.au)



For NDIS Item Code, refer to page: 508





## Aquatec Ocean Mobile Shower Commode (Transit)

- The chairs all have height adjustable armrests, footrests, and overall height making the chairs comfortable and safe for both patient and carer
- Transit version can be retrofitted to self-propelled model
- All metal parts are made of stainless steel, including the inside and outside of the gas spring on the Ocean VIP
- Seat height has three tool-less height adjustments to suit bed/chair/wheelchair transfers
- Tool-less, height-adjustable seat and footplate
- Ergonomic, flip-up armrests are also height adjustable (Allen key required - supplied)
- Washable, tension-adjustable backrest with quick-release buckles
- Ergonomically-designed seat
- 4 brake castors for optimum safety
- Directional castor lock
- Easy to clean with removable seat and smooth surfaces
- Full range of accessories available
- Comes with soft seat, pan holder and pan with lid as standard
- Warranty – 5 years on frame, 2 years on components, 6 months on seat and backrest cover

Code	Description	Overall Height	Overall Width	Seat Depth	Seat Width	Armrest Height	Lower Leg Length	Product Weight	S.W.L	DVA:
BTC083720	Ocean Mobile Shower Commode (Transit)	477 - 600 mm	560 mm	450 mm	480 mm	680 - 810 mm	280 - 530 mm	14.5 kg	150 kg	BE04
BTC083730	Ocean Mobile Shower Commode (Self Propelled)	477 - 600 mm	675 mm	450 mm	480 mm	680 - 810 mm	280 - 530 mm	19.5 kg	150 kg	BE04



## Aquatec Ocean VIP Shower Commode with Tilt

- Seat tilt can be individually adjusted (tilt angle 0° - 35°)
- Height adjustable armrests, footrests and overall height
- All metal parts are made of stainless steel
- Seat height has three tool-less height adjustments to suit bed/chair/wheelchair transfers
- Height and angle adjustable footrests (Tool-less)
- Washable, tension-adjustable backrest with quick-release buckles
- Ergonomically-designed seat
- 4 braked castors for optimum safety
- Directional castor lock
- Full range of accessories available
- Comes with soft seat, pan holder and pan with lid as standard
- Warranty – 5 years frame, 2 years components, 6 months on seat and backrest cover

Code	Description	Overall Height	Overall Width	Seat Depth	Seat Width	Armrest Height	Product Weight	S.W.L	DVA:
BTC083710	Ocean VIP Shower Commode - Tilt	420 - 520 mm	595 mm	450 mm	500 mm	215 - 245 mm	23.5 kg	150 kg	BE04
BTC083715	Ocean VIP Shower Commode - Tilt w/Reclining Backrest	420 - 520 mm	625 mm	450 mm	500 mm	215 - 245 mm	28.3 kg	150 kg	-

## Aquatec Ocean VIP Accessories



Code	Description	Code	Description
BTC087606	Shower Commode Safety Bar - Invacare (Ocean & VIP models)	BTC087626	Shower Commode Armrest Lock (Ocean)
BTC087608	Shower Commode Safety Bar - Invacare (XL models)	BTC087628	Shower Commode Armrest (Ocean XL)
BTC087610	Safety Frame (Toilet-Knockdown)	BTC087630	Shower Commode Chest Belt (Ocean & Vip)
BTC087612	Shower Commode Calf Support - Below Knee (Ocean - L or R)	BTC087632	Shower Commode Pelvis Belt (Ocean & Vip)
BTC087614	Shower Commode Calf Support - Above Knee (Ocean XI - L or R)	BTC087636	Shower Commode Anti-Tippers (Ocean & Vip)
BTC087616	Shower Commode Calf Support - Above Knee (Ocean VIP - Left)	BTC087640	Shower Commode Seat - Universal Soft Seat Ocean
BTC087618	Shower Commode Calf Support - Above Knee (Ocean VIP - Right)	BTC087642	Shower Commode Seat - Ergonomic Hygiene Recess Seat
BTC087620	Shower Commode Calf Support - Below Knee (Ocean VIP - Left)	BTC087648	Shower Commode Insert (Recess Cover-Soft Seat)
BTC087622	Shower Commode Calf Support - Below Knee (Ocean VIP - Right)	BTC087644	Shower Commode Clip Frame (Ocean)
BTC087624	Shower Commode Armrest Lock (Ocean Vip)	BTC087638	Shower Commode Flat Pin (Height-Adj-Footrest)

### General Enquiries

P 1300 133 120 | E sales@aidacare.com.au | W www.aidacare.com.au



**K Care Shower Commode Budget**

Code	Description
BTC070400	Budget - Att Prop
BTC081100	Optional Sliding Footplate



**K Care Shower Commode with Platform Footrest**

Code	Description
BTC070600	WB Platform - S/Steel
BTC070800	WB Platform - Zinc Treated



**K Care Shower Commode with Weight Bearing Platform**

Code	Description
BTC070650	WB Platform - Att Prop
BTC077950	WB Platform - Self Prop



**K Care Shower Commode Swing Away Footrest**

Code	Description
BTC071000	SA Footrest - 400mm - Att Prop
BTC070900	SA Footrest - 440mm - Att Prop
BTC062000	SA Footrest - 500mm - Att Prop



**K Care Shower Commode Self Propelling**

Code	Description
BTC077900	SA Footrest - 440mm - Self Prop
BTC063400	SA Footrest - 500mm - Self Prop



**K Care Shower Commode Folding**

Code	Description
BTC071400	Folding - SA Footrest - Att Prop
BTC080500	Folding - SA Footrest - Self Prop
BTC080600	Folding - Left Hand Opening Frame - SA Footrest - Self Prop
BTC080700	Folding - Right Hand Opening Frame - SA Footrest - Self Prop



**K Care Shower Commode Child**

Code	Description
BTC084800	Child - SA Footrest - Att Prop
BTC085200	Child - SA Footrest - Self Prop



**K Care Shower Commode Maxi**

Code	Description
BTC062100	Maxi - SA Footrest - 500mm - Att Prop
BTC062200	Maxi - SA Footrest - 600mm - Att Prop
BTC062300	Maxi - SA Footrest - 650mm - Att Prop



**K Care Shower Commode Maxi Platform Footrest**

Code	Description
BTC061600	Maxi - WB Platform - 500mm - Att Prop
BTC061700	Maxi - WB Platform - 550mm - Att Prop
BTC061800	Maxi - WB Platform - 600mm - Att Prop
BTC061900	Maxi - WB Platform - 650mm - Att Prop



**K Care Shower Commode Tilt**

Code	Description
BTC071100	Tilt - SA Footrest - 440mm
BTC071200	Tilt Deluxe - Padded Armrests & Side Panels - 440mm
BTC071350	Tilt - SA Footrest - 500mm



**K Care Shower Commode Maxi Tilt (Electric)**

Code	Description
BTC064300	Maxi Tilt (Electric) - Att Prop - 600mm



## Hand Made Seat - Open

- Superior quality white marine grade vinyl provides durability and comfort
- Vinyl is wrapped, stapled and sealed, making cleaning easier with no seam on the inside of the aperture
- Comes with plastic seat runners for easy attachment and removal for cleaning
- Seat height: 55mm
- Warranty: 1 year

Code	Description	Seat Depth	Seat Width
BTC085000	Hand Made Open Front Seat 32	430 mm	320 mm
BTC073900	Hand Made Open Front Seat 40	430 mm	400 mm
BTC074400	Hand Made Open Front Seat 44	430 mm	440 mm
BTC062800	Hand Made Open Front Seat 50	430 mm	500 mm
BTC062900	Hand Made Open Front Seat 55	430 mm	550 mm
BTC063000	Hand Made Open Front Seat 60	430 mm	600 mm
BTC063100	Hand Made Open Front Seat 65	430 mm	650 mm
BTC074000	Hand Made Open Left Seat 44	430 mm	440 mm
BTC074500	Hand Made Open Right Seat 44	430 mm	440 mm



## Hand Made Seat - Closed

- Superior quality white marine grade vinyl provides durability and comfort
- Vinyl is wrapped, stapled and sealed, making cleaning easier with no seam on the inside of the aperture
- Comes with plastic seat runners for easy attachment and removal for cleaning
- Seat height: 55mm
- Warranty: 1 year

Code	Description	Seat Depth	Seat Width
BTC084900	Hand Made Closed Seat 32	430 mm	320 mm
BTC073800	Hand Made Closed Seat 40	430 mm	400 mm
BTC073700	Hand Made Closed Seat 44	430 mm	440 mm
BTC062400	Hand Made Closed Seat 50	430 mm	500 mm
BTC062500	Hand Made Closed Seat 55	430 mm	550 mm
BTC062600	Hand Made Closed Seat 60	430 mm	600 mm
BTC062700	Hand Made Closed Seat 65	430 mm	650 mm

## K Care Shower Commode Accessory Range

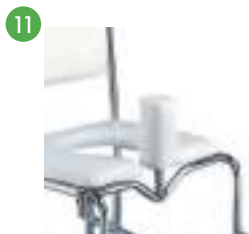



## K Care Shower Commodes Accessories Matrix

### Accessories Fit Commode Code(s)

		Accessories Fit Commode Code(s)																									
		BTC070400	BTC070600	BTC070800	BTC070650	BTC070900	BTC077950	BTC071000	BTC084800	BTC085200	BTC071400	BTC080500	BTC080600	BTC080700	BTC077900	BTC071100	BTC071200	BTC062200	BTC062000	BTC062000	BTC061600	BTC061700	BTC061800	BTC061900	BTC063400		
Code	Accessory Description																										
		DVA:																									
1	BTC075500 Urethane Closed Seat 440 mm	-	BE04		BE04	BE04		BE04										BE04	BE04	BE04	BE04	BE04	BE04		BE04		
2	BTC075700 Urethane Open Seat 440 mm	-																									
3	BTC080200 Stump Support Right	-																									
	BTC079900 Stump Support Left	-																									
4	BTC075900 Padded Tie on Closed Seat	-																									
5	BTC074600 IV Pole	-																									
6	BTC076600 Bowl Carrier S/S	-																									
	BTC076500 Bowl Carrier S/S Junior	BE04																									
	BTC081610 Commode Bowl with Lid & Handle	BE03																									
7	BTC077100 Pan Carrier S/S	BE04																									
	BTC077000 Pan Carrier S/S Junior	-																									
	BTT151800 Bed Pan	-																									
8	BTT148000 Bed Pan (Slipper) - Small	BE03																									
	BTT161500 Bed Pan (Slipper) - Large	BE03																									
9	BTC075000 Oxygen Bottle Carrier	-																									
	BTC074800 Lock Down Arms	-																									
	BTC071600 Folding Safety Arms	BE03																									
10	BTC079600 Contoured Headrest	-																									
11	BTC075100 Pommel	-																									
12	BTC078300 Anti Tip Bars	BE11																									
	BTC075300 Fixed Curved Padded Back	-																									
	BTC078400 Brake Extension	-																									
	BTC078900 Footplate Extended	-																									
13	BTC080300 Swing Away Footrests	-																									
	BTC080350 Swing Away Footrests for BTC062100	-																									
14	BTC078500 Elevating Footrest - Left	-																									
	BTC078700 Elevating Footrest - Right	-																									
	BTC072200 Padded Arms	-																									
	BTC071900 Swing Up Arms	-																									
15	BTC071800 Pelvic Strap - Fitted	BE04																									
	BTC077200 Pelvic Chest Strap	-																									
	BTC072300 Padded Arms - Fitted	-																									
	BTC072350 Padded Arms - Swing Up	-																									
	BTC072000 Swing Up Arms - Short	-																									
	BTC071900 Swing Up Arms S/Steel	-																									
16	BTC073500 Gutter Supports	BE04																									

### DVA Contact Details

P 1300 888 052 | F 1300 787 052 | E [dva@aidacare.com.au](mailto:dva@aidacare.com.au)



For NDIS Item Code, refer to page: 508



# Shower Seating



For NDIS Item Code, refer to page: 508



Brochures also available. Please contact us for a copy.

## Aspire Shower Chair



Contoured Plastic Seat for Comfort



Raised Armrests to Assist with Transfer



Heavy Duty, Reinforced Frame 200kg



Durable Non-slip Feet for Safety



Height Adjustable Legs to Suit User

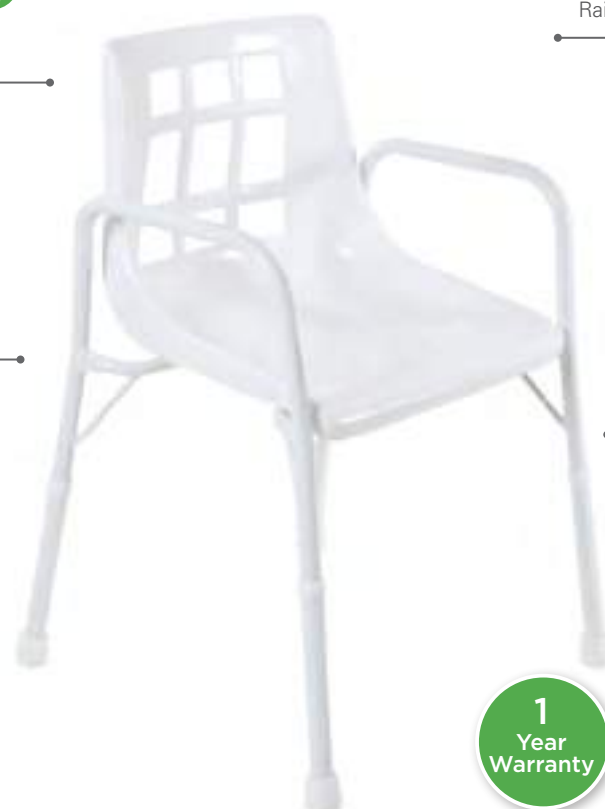
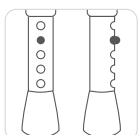

Structure



Corrosion



Code	Description	Overall Height	Overall Width	Overall Depth	Seat Depth	Seat Width	Between Arms	Seat Height	Product Weight	DVA:
BTS118000	Shower Chair with Arms - Steel	735 - 910 mm	512 mm	570 mm	400 mm	440 mm	470 mm	375 - 550 mm	3.4 kg	AZ04
BTS118005	Shower Chair with Arms - Aluminium	735 - 910 mm	512 mm	570 mm	400 mm	440 mm	470 mm	375 - 550 mm	3.1 kg	AZ04

### General Enquiries

P 1300 133 120 | E sales@aidacare.com.au | W www.aidacare.com.au





## Aspire Shower Chair - Wide



Contoured Plastic Seat for Comfort



Heavy Duty, Reinforced Frame 200kg



Height Adjustable Legs to Suit User



Raised Armrests to Assist with Transfer



Durable Non-slip Feet for Safety



Structure



Corrosion



S.W.L  
200kg

Code	Description	Overall Height	Overall Width	Overall Depth	Seat Depth	Seat Width	Between Arms	Seat Height	Product Weight	DVA:
BTS118010	Shower Chair with Arms - Wide - Steel	735 - 910 mm	570 mm	570 mm	400 mm	440 mm	525 mm	375 - 550 mm	3.9 kg	AZ04
BTS118015	Shower Chair with Arms - Wide - Aluminium	735 - 910 mm	570 mm	570 mm	400 mm	440 mm	525 mm	375 - 550 mm	3.3 kg	AZ04

## Aspire MAXI Shower Chair



Super Heavy Duty Width Adjustable Frame to 775mm



Reinforced Aluminium Frame Accommodates Bariatric Users and is Corrosion Resistant



Height Adjustable Legs With Easy Circlip Adjustment Points For Changing Needs

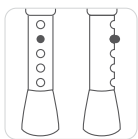

Soft Padding on Seat and Arms for Postural Support and Comfort



Durable Non-Slip Feet for Safety



Structure



Corrosion



S.W.L  
310kg

Code	Description	Overall Height	Overall Width	Overall Depth	Seat Depth	Seat Width	Between Arms	Seat Height	DVA:
BTS118020	MAXI Shower Chair	670 - 1005 mm	645 - 845 mm	495 mm	455 mm	575 - 775 mm	575 - 775 mm	455 - 575 mm	AZ04

### DVA Contact Details

P 1300 888 052 | F 1300 787 052 | E [dva@aidacare.com.au](mailto:dva@aidacare.com.au)



For NDIS Item Code, refer to page: 508



## Shower Chair No Arms (Zinc Treated)

- This shower chair has no arms to allow more access for showering
- The chair is equipped with a moulded contoured seat for added comfort and support
- Zinc treated for corrosion resistance

Code	Description	Frame Width	Seat Depth	Seat Width	Seat Height	Product Wt.	S.W.L
BTS114800	Shower Chair - No Arms (Zinc Treated)	450 mm	430 mm	440 mm	420 - 550 mm	2.15 kg	110 kg



## Shower Stool No Arms & Padded Seat (Zinc Treated)

- Shower stool with no arms assists showering access
- Fully adjustable seat height and angle to suit user
- Zinc treated for corrosion resistance
- Moulded clip on seat for quick assembly, cleaning or replacement
- Fitted with non-slip rubber tips

Code	Description	Seat Depth	Seat Width	Seat Height	S.W.L	Warranty
BTS115400	Shower Stool No Arms & Padded Seat - 350mm Seat (Zinc Treated)	300 mm	350 mm	440 - 610 mm	110 kg	1 Year
BTS115100	Shower Stool No Arms (Zinc Treated)	300 mm	350 mm	440 - 610 mm	110 kg	1 Year

## Aspire Shower Stool



Code	Description	Overall Height	Overall Width	Overall Depth	Seat Depth	Seat Width	Between Arms	Seat Height	Product Weight	DVA:
BTS119000	Shower Stool - Steel	670 - 855 mm	545 mm	400 mm	310 mm	375 mm	495 mm	470 - 655 mm	3.8 kg	AZ04
BTS119005	Shower Stool - Aluminium	670 - 855 mm	545 mm	400 mm	310 mm	375 mm	495 mm	470 - 655 mm	3.1 kg	AZ04

### General Enquiries

P 1300 133 120 | E sales@aidacare.com.au | W www.aidacare.com.au



## Aspire Shower Stool with Padded Seat



Raised Armrests to Assist with Transfers



Clip On Padded Seat for Comfort

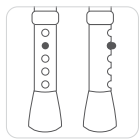

Height Adjustable Legs to Assist User



Seat Angled to Help with Standing

Heavy Duty Frame 175kg



Durable Non-slip Feet for Safety



Structure



Corrosion



Code	Description	Overall Height	Overall Width	Overall Depth	Seat Depth	Seat Width	Between Arms	Seat Height	Product Weight	DVA:
BTS119020	Shower Stool with Padded Seat (PS) - Steel	670 - 855 mm	545 mm	400 mm	310 mm	375 mm	495 mm	470 - 655 mm	3.8 kg	AZ04

## Aspire Shower Stool with Padded Seat & Back



Raised Armrests to Assist with Transfer



Clip On Seat & Padded Backrest for Comfort

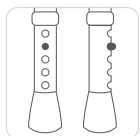

Height Adjustable Legs to Suit User



Seat Angled to Help with Standing

Heavy Duty, Reinforced Frame 175kg

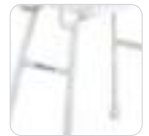

Durable Non-slip Feet for Safety



Structure



Corrosion

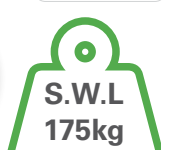

Code	Description	Overall Height	Overall Width	Overall Depth	Seat Depth	Seat Width	Between Arms	Seat Height	Product Weight	DVA:
BTS119025	Shower Stool with Padded Seat & Back - (PS & B) Aluminium	670 - 855 mm	545 mm	400 mm	310 mm	375 mm	495 mm	470 - 655 mm	6.8 kg	AZ04

### DVA Contact Details

P 1300 888 052 | F 1300 787 052 | E [dva@aidacare.com.au](mailto:dva@aidacare.com.au)



For NDIS Item Code, refer to page: 508





## Aspire Shower Stool - Wide



Raised Armrests to Assist with Transfer



Clip On Seat & Padded Backrest for Comfort

Height Adjustable Legs to Suit User

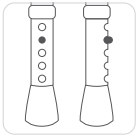

Seat Angled to Help with Standing

Reinforced, Wide Frame 175kg



Durable Non-slip Feet for Safety



Structure



Corrosion



S.W.L  
175kg

Code	Description	Overall Height	Overall Width	Overall Depth	Seat Depth	Seat Width	Between Arms	Seat Height	Product Weight	DVA:
BTS119010	Shower Stool - Wide - Steel	575 - 765 mm	570 mm	500 mm	365 mm	420 mm	525 mm	425 - 615 mm	3.8 kg	AZ04
BTS119015	Shower Stool - Wide - Aluminium	575 - 765 mm	570 mm	500 mm	365 mm	420 mm	525 mm	425 - 615 mm	3.1 kg	AZ04

## Aspire MAXI Shower Stool



Super Heavy Duty Width Adjustable Frame to 775mm



Reinforced Aluminium Frame Accommodates Bariatric Users And Is Corrosion Resistant



Height Adjustable Legs With Easy Circlip Adjustment Points for Changing Needs

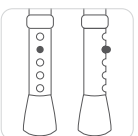

Raised Armrests - Assist the User Transferring On and Off The Stool



Durable Non-slip Feet for Safety



Structure



Corrosion



S.W.L  
310kg

Code	Description	Overall Height	Overall Width	Overall Depth	Seat Depth	Seat Width	Between Arms	Seat Height	DVA:
BTS119030	MAXI Shower Stool	670 - 790 mm	645 - 845 mm	495 mm	455 mm	575 - 775 mm	575 - 775 mm	455 - 575 mm	AZ04

### General Enquiries

P 1300 133 120 | E sales@aidacare.com.au | W www.aidacare.com.au



## Shower Stool with Strapping

- Unique strapped PVC tube seat provides the user with maximum comfort
- Fully adjustable seat height to suit user
- Fitted with non-slip rubber tips

Code	Description	Frame Width	Seat Depth	Seat Width	Seat Height	S.W.L	Warranty	DVA:
BTS113600	Shower Stool with Strapping	430 mm	290 mm	410 mm	475 - 605 mm	100 kg	1 year	AZ04



## Shower Stool Maxi Compact

- Reinforced compact design shower stool for the bariatric user
- Fully adjustable seat height to suit user
- Lightweight aluminium construction
- Fitted with non-slip rubber foot pads

Code	Description	Seat Depth	Seat Width	Seat Height	S.W.L	DVA:
BTS105200	Shower Stool Maxi Compact	380 mm	510 mm	380 - 480 mm	227 kg	AZ04



## Wall - Mounted Shower Seat

- Adjustable leg for added strength and allows for variable seat angle
- Folds away against the wall
- Weight capacity dependant on fixing method
- Durable stainless steel frame
- Note: shower seats should be installed by a qualified tradesperson

Code	Description	Seat Depth	Seat Width	Seat Height	Product Weight	S.W.L	Warranty
BTS115700	Shower Seat - Small	300 mm	350 mm	480 mm	3 kg	125 kg	1 Year
BTS116100	Shower Seat - Large	400 mm	960 mm	480 mm	7 kg	125 kg	1 Year



## Sitz Bath Chair

- Sit-in wash bath for therapeutic personal washing or cleansing, particularly post child birth
- Durable fibreglass construction
- In-built plug and drain fitted with directional hose for improved drainage

Code	Description	Seat Depth	Seat Width	Seat Height	Product Weight	S.W.L	Warranty
BTS119700	Sitz Bath Chair	380 mm	580 mm	560 mm	7 kg	125 kg	1 year



## Shower Chair & Commode Chair Belt

- Assists support the pelvic position of the user whilst in the mobile shower commode
- Modifications may be required as this is a custom made commode fitting

Code	Description	Warranty
BTS124500	Shower Chair Belt	1 year



## Body Point Shower Belt

- Assists support the user and carer during showering
- Body Point shower chair belt uses Aeromesh™ fabric and dries quickly after use
- Water and air easily pass through fabric so user can be bathed completely
- Universal shape for flexibility of use depending on needs
- Can be fitted across the chest, abdomen, knees or legs to prevent forward or lateral falls and for slippage
- Clamps available separately

Code	Description	Clamp Size	Warranty
BTS117730	Shower Belt - Medium (No Clamps)	-	1 year
BTS117735	Shower Belt - Large (No Clamps)	-	1 year
BTS117740	Clamps for Shower Belt - Pack of 2	22 mm	1 year

# Toileting Aids



For NDIS Item Code, refer to page: 508



## Aspire Over Toilet Aid



Raised Armrests to Assist with Transfer



Comfortable, Contoured Seat



Height Adjustable Legs to Suit User

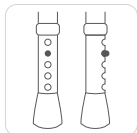

Removable Splash Guard for Cleaning



Heavy Duty Reinforced Frame 175kg

Durable Non-slip Feet for Safety



Structure



Corrosion



S.W.L  
175kg

Code	Description	Overall Height	Overall Width	Overall Depth	Seat Depth	Seat Width	Seat Height	Between Arms	Product Weight	DVA:
BTT145000	Over Toilet Aid - Steel	700 - 880 mm	512 mm	625 mm	435 mm	370 mm	450 - 630 mm	460 mm	4.2 kg	BE06
BTT145005	Over Toilet Aid - Aluminium	700 - 880 mm	512 mm	625 mm	435 mm	370 mm	450 - 630 mm	460 mm	3.4 kg	BE06

### General Enquiries

P 1300 133 120 | E sales@aidacare.com.au | W www.aidacare.com.au



## Aspire Over Toilet Aid - Wide



Raised Armrests to Assist with Transfer



Comfortable, Contoured Seat



Height Adjustable Legs to Suit User

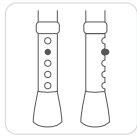

Heavy Duty Reinforced Frame 175kg

Removable Splash Guard for Cleaning



Durable Non-slip Feet for Safety



**1**  
Year  
Warranty

Structure

**5**  
Year  
Warranty

Corrosion



**S.W.L**  
**175kg**

Code	Description	Overall Height	Overall Width	Overall Depth	Seat Depth	Seat Width	Seat Height	Between Arms	Unit Weight	DVA:
BTT145010	Over Toilet Aid - Wide - Steel	700 - 880 mm	570 mm	625 mm	435 mm	370 mm	450 - 630 mm	525 mm	4.2 kg	BE06
BTT145015	Over Toilet Aid - Wide - Aluminium	700 - 880 mm	570 mm	625 mm	435 mm	370 mm	450 - 630 mm	525 mm	3.4 kg	BE06

## Aspire MAXI Over Toilet Aid



Reinforced Aluminium Frame  
Accommodates Bariatric Users and  
is Corrosion Resistant



Height Adjustable Legs with  
Easy Circlip Adjustment Points  
for Changing Needs

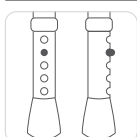

Super Heavy Duty Width Adjustable  
Frame to 775mm



Flip Up Padded Seat For Ease Of Cleaning



Durable Non-slip Feet for Safety



**1**  
Year  
Warranty

Structure

**5**  
Year  
Warranty

Corrosion



**S.W.L**  
**310kg**

Code	Description	Overall Height	Overall Width	Overall Depth	Seat Depth	Seat Width	Between Arms	Seat Height	DVA:
BTT145020	MAXI Over Toilet Aid	670 - 790 mm	645 - 845 mm	495 mm	455 mm	575 - 775 mm	575 - 775 mm	455 - 575 mm	BE06

### DVA Contact Details

P 1300 888 052 | F 1300 787 052 | E [dva@aidacare.com.au](mailto:dva@aidacare.com.au)



For NDIS Item Code,  
refer to page: 508



## Over Toilet Aid Folding (Zinc Treated)

- Easy to fold up design ideal for use whilst travelling or for storage
- Fully adjustable seat height to suit user
- Fitted with non-slip rubber tips
- Removable lift back seat for easy cleaning
- Zinc treated for corrosion resistance

Code	Description	Seat Depth	Seat Height	Between Arms	Product Weight	S.W.L	Warranty
BTT154700	Over Toilet Aid Folding, Zinc Treated	420 mm	480 - 620 mm	445 mm	4 kg	110 kg	1 Year



## Over Toilet Aid U Frame

- U Frame features a quick and easy spring and button assembly and removable moulded toilet seat
- Fully adjustable seat height to suit user
- Fitted with non-slip rubber tips
- Frame is galvanised internally and externally for superior corrosion resistance

Code	Description	Seat Depth	Seat Width	Seat Height	Between Arms	Product Weight	S.W.L	Warranty	DVA:
BTT156700	Over Toilet Aid U Frame	420 mm	370 mm	490 - 610 mm	510 mm	4.5 kg	110 kg	1 Year	BE06
BTT156600	Splash Guard to Suit U Frame								



## Splash Guard

- Replacement splash guard to suit all Over Toilet Aids

Code	Description
BTT153900	Splash Guard



## Toilet Seat Flap

- Replacement flap for Aspire Over Toilet Aids

Code	Description
BTT145100	Toilet Seat Flaps

## Aspire Toilet Surround Frame



Raised Armrests to Assist with Transfers



Durable Non-slip Feet for Safety



Heavy Duty Frame 175kg



Height Adjustable Frame to Suit User

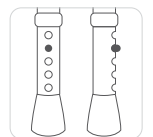

Code	Description	Overall Height	Overall Width	Overall Depth	Between Arms	Unit Weight	DVA:
BTT155100	Toilet Surround - Aluminium	535 - 600 mm	500 mm	435 mm	450 mm	3 kg	BE06





# Other Toileting Aids

**I ♥ ndis** For NDIS Item Code, refer to page: 508

## Aspire Raised Toilet Seat - No Lid



Code	Description	Overall Height	Unit Weight	DVA:
BTT149800	Toilet Seat Raiser - 50mm - No Lid	50 mm	1.4 kg	BE10
BTT150200	Toilet Seat Raiser - 100mm - No Lid	100 mm	1.4 kg	BE10
BTT150300	Toilet Seat Raiser - 150mm - No Lid	150 mm	1.4 kg	BE10

### DVA Contact Details

P 1300 888 052 | F 1300 787 052 | E [dva@aidacare.com.au](mailto:dva@aidacare.com.au)

**I ♥ ndis** For NDIS Item Code, refer to page: 508





## Aspire Raised Toilet Seat - With Lid



Bathroom & Toilet

Contoured Plastic Seat for Comfort

Adjustable Mounting Brackets



Cut Out Front & Rear for Access

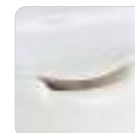

150 mm (6")

100 mm (4")

50 mm (2")



Code	Description	Overall Height	Unit Weight	DVA:
BTT149900	Toilet Seat Raiser - 50mm - With Lid	50 mm	1.4 kg	BE10
BTT150100	Toilet Seat Raiser - 100mm - With Lid	100 mm	1.4 kg	BE10
BTT150400	Toilet Seat Raiser - 150mm - With Lid	150 mm	1.4 kg	BE10



### Raised Toilet Seat with Swing Back Arms

- This raised toilet seat features swing back arms and is height adjustable
- Fits most standard toilets
- Fixes onto the toilet bowl for safe transferring (replaces existing seat & lid)

Code	Description	S.W.L	DVA:
BTT150450	Raised Toilet Seat with Swing Back Arms	120 kg	BE10



### Bottom Wiper

- Assists the user with personal cleaning after toileting
- Moulded plastic head with recessed serrations to grip the paper
- Mounted on a lightweight curved handle it is designed to be used from the front
- Paper easily removed after use



### Bottom Wiper Folding

- Folds into three for easier storage
- Moulded plastic head with recessed serrations to grip the paper
- Mounted on a lightweight curved handle it is designed to be used from the front
- Paper easily removed after use

Code	Description	Warranty	DVA:
BTT150600	Bottom Wiper	1 year	AU01

Code	Description	Warranty	DVA:
BTT150700	Bottom Wiper Folding	1 year	AU01

#### General Enquiries

P 1300 133 120 | E sales@aidacare.com.au | W www.aidacare.com.au



### Portable Bidet

- A strong plastic bowl that has a soap dish at the front and fits inside most toilet bowls to create a bidet

Code	Description	Width	Length	DVA:
BTT150500	Portable Bidet	340 mm	350 mm	BE01



### Deluxe Electric Bidet

- Electrically operated bidet with advanced remote control
- Soft closing lid
- Heated seat with 3 x temperature settings
- Multiple cycle options

Code	Description	Width	Length	Depth	DVA:
BTT150110	Electric Bidet	340 mm	350 mm	500 mm	BE01



### Standard Electric Bidet

- Electrically operated bidet with standard remote control
- Soft closing lid
- Heated seat
- Heated water cycle
- Built in air dryer

Code	Description	Depth	Inner Seat Diameter	DVA:
BTT150120	Standard Electric Bidet	480 mm	310 mm	BE01



### Small Electric Bidet

- Electrically operated bidet with standard remote control
- Designed for the smaller user
- Soft closing lid
- Heated seat
- Heated water cycle

Code	Description	Depth	Inner Seat Diameter
BTT150115	Standard Electric Bidet	480 mm	310 mm



### Disposable Urinal

- This is a disposable urinal that is convenient, sanitary, discrete and compact
- It features a unisex adapter making it easy for anyone to use whilst standing or sitting
- Each box contains three urinals

Code	Description
BTT157400	Disposable Urinal



# Transfer Aids



For NDIS Item Code, refer to page: 508



## Bath Lift



- An electric bath chair that lowers and lifts the user in and out of the bath, reducing the strain on the carer and preventing the risk of falls
- Stable, robust frame with reinforced scissors and base plate ensure stability and safety
- High backrest with contoured neckrest, can be positioned and folded with just one hand
- Backrest can be reclined up to 40°
- Ergonomic, floating hand control is easy to grasp
- Removable, machine-washable covers
- Optimised base plate - significantly more space in the bathtub
- Patented, self-release suction cups: easy removal
- Wide range of accessories for individual customisation
- Accessories available include height adaptor, pelvic belt, chest belt, adjustable head-rest and special reclining backrest



Code	Description	Seat Length	Seat Width	Seat Height	Seat Depth	Height of Backrest	S.W.L	Product Weight	DVA:
BTS112250	Bath Lift	580 mm	375 - 715 mm	60 - 420 mm	490 mm	665 mm	135 kg	12.10 kg	-
BTS112710	Bath Lift - Aqua Joy	580 mm	390 - 686 mm	90 - 465 mm	490 mm	604 mm	170 kg	13.64 kg	AZ07

## Bath Step



- Assists with daily activities, especially getting into and out of the bath
- Large textured surface gives the user confidence and provides additional safety
- Modular construction allows flexibility of design by creating a larger or smaller step by adding on top or clipping together
- Each additional step adds 50mm to the height of the step, up to a maximum of six steps equal to 355mm
- Foam pad fits neatly onto the surface of the step, making it warm and soft underfoot
- Cut-away hand space for easy lifting

Code	Description	Surface Area	Bath Step Height	Footprint	Product Weight	S.W.L	Warranty
BTS112750	Bath Step Modular	356 x 457 mm	100 mm	381 x 483 mm	1.3 kg	190 kg	1 year



### Bath Transfer Bench Padded

- Padded seat & backrest provides a cushioned surface for comfort
- Highly resilient vinyl covering
- Fully height adjustable with a side arm for secure transfers
- Adjustable backrest to suit right or left facing tubs
- Suction cup foot pieces secure the bench to the tub floor
- Lightweight aluminium frame construction

Code	Description	Overall Width	Overall Depth	Seat Depth	Seat Width	Seat Height	Product Weight	S.W.L	DVA:
BTS110900	Bath Transfer Bench - Padded	770 mm	530 mm	410 mm	670 mm	410 - 530 mm	7.5 kg	136 kg	AZ01
BTS108200	Bath Transfer Bench - Plastic	770 mm	530 mm	410 mm	670 mm	410 - 530 mm	7.2 kg	136 kg	AZ01
BTS108300	Leg Extension Options								



### Bath Transfer Bench Bariatric

- Reinforced design for the bariatric user with a maximum weight of 227kg
- It has a textured moulded plastic seat and backrest
- Fully height adjustable with a side arm for secure transfers
- Adjustable backrest to suit right or left facing tubs
- Suction cup foot pieces secure the bench to the tub floor
- Lightweight aluminium frame construction

Code	Description	Overall Width	Overall Depth	Seat Depth	Seat Width	Seat Height	Product Weight	S.W.L	DVA:
BTS105300	Bath Transfer Bench Bariatric	775 mm	584 mm	410 mm	670 mm	390 - 520 mm	7.2 kg	227 kg	AZ01



### Swivel Bather Shower and Bath Chairs

- The Swivel Bather Chair's rotating seat allows for easy transfer over the bath/shower
- Fully height adjustable floor standing base unit
- Can be removed instantly for normal shower use
- Chair attaches to all standard bath sizes/styles and can be removed instantly for normal bath use
- Spacers available to adjust bather height
- New "Ultra" Aluminium 160kg model



Code	Description	Seat Width	Seat Height	Width Over Bath	Length	Product Weight	S.W.L	Warranty	DVA:
BTS107100	MYCO Swivel Shower Chair	445 mm	430 - 510 mm	-	-	-	100 kg	1 Year	AZ01
BTS107050	MYCO Swivel Bath Chair (Wide Arm)	445 mm	-	710 mm	660 mm	5.5 kg	127 kg	1 Year	AZ01
BTS106700	MYCO Swivel Bath Chair (Corner)	445 mm	-	710 mm	660 mm	5.5 kg	100 kg	1 Year	AZ01
BTS106540	MYCO ULTRA Swivel Bathchair (Alum)	535 mm	-	710 mm	660 mm	5.5 kg	160 kg	1 Year	AZ01
BTS106550	MYCO Swivel Bather Bath Chair	445 mm	-	710 mm	660 mm	5.5 kg	100 kg	1 Year	-
BTS106800	MYCO Swivel Bather Spacer 3" (750 mm)								
BTS106950	MYCO ULTRA Swivel Bath Spacer 4" (1000 mm)								
BTS106900	MYCO Swivel Bather Spacer 6" (1500 mm)								



## Swivel Bather Chair

- This shower chair has a base-frame which fits over the bath, with easy-to-clean plastic
- Sturdy, swivels 360° and secures with a locking lever
- Drainage holes.

Code	Description	Seat Width	Seat Height	S.W.L	Warranty	DVA:
BTS106500	Bath Chair - Swivel Bather	415 mm	356 mm	113 kg	1 Year	AZ01



## Bath Board

- The Fresh Bath Board provides a stable seat over the bath when bathing or showering
- Features an easy grip handle for secure transfers, non slip surface, drainage holes and adjustable legs to fit a variety of tub sizes

Code	Description	Overall Width	Overall Depth	Product Weight	S.W.L	Warranty	DVA:
BTS113700	Fresh Bath Board	690 mm	350 mm	3 kg	150 kg	1 year	AZ01



## Bath/Shower Board - Savannah - Slatted Seat

- A slatted, plastic and wood, adjustable bath board
- Featuring a curved plastic securing bracket under each end
- Slip resistant grips on the underside of the board provide additional slip resistance on the bath edge

Code	Description	Surface Area	S.W.L	Warranty	DVA:
BTS113700	Bath/Shower Board - Savannah - Slatted Seat	533 x 635 mm	190 kg	1 Year	AZ01
BTS111700	Bath/Shower Board - Savannah - Slatted Seat - Large	584 x 686 mm	190 kg	1 Year	AZ01
BTS111600	Handle (Optional)			1 Year	-

Shown with Optional Handle





# Other Bathing

I ♥ ndis For NDIS Item Code, refer to page: 508

## Waterproof Limb, Cast, Bandage Protectors



### LimbO

#### Overview

Waterproof limb protection for casts, wound and leg ulcer dressings and compression garments

- LimbO waterproof protectors are comfortable, easy-to-use, and reusable. They can be completely submerged for bathing, swimming or in hydro pools
- The LimbO is a self-sealing, self supporting garment which prevents the penetration of water to plaster casts, compression garments and wound dressings on limbs during bathing
- It is a non-sterile product and is primarily intended for use in a bath or shower

#### To Order

Order by product code

### Hand/Wrist - LO AH MITT

✓ DVA: AZ06



#### FEATURES

- Standard size fits most adults with forearm circumference of 220 - 250mm when measured 50mm below the elbow
- Seals 100mms above the hand
- Not suitable for use with thumb injuries
- Please use the Adult Elbow Protector for thumb injuries

Code	Arm Circ (mm)
PTA534101	220 - 250

#### DVA Contact Details

P 1300 888 052 | F 1300 787 052 | E dva@aidacare.com.au

I ♥ ndis For NDIS Item Code, refer to page: 508





## Limbo (cont.)

Bathroom & Toilet



### Adult Below Elbow - LO ABE

✓ DVA: AZ06

Code	Size	Arm Circ (mm)
PTA534102	X-Small	220 - 250
PTA534102S	Small	250 - 290
PTA534102L	Large	300 - 400

Measure arm circumference 80mm above the elbow.



### Adult Full Arm - LO AFA

✓ DVA: AZ06

Code	Size	Arm Circ (mm)
PTA534103	Small	250 - 290
PTA534103L	Large	300 - 400

Measure circumference at top of arm above cast/bandage.



### Adult Elbow - LO AE

✓ DVA: AZ06

Code	Size	Arm Circ (mm)
PTA534104	Small	250 - 290
PTA534104L	Large	300 - 400

Measure upper arm circumference.

## Adult Below Knee - LO ABK

✓ DVA: AZ06



#### SIZING

- Determine user height first, and then take leg circumference to determine garment size
- Leg circumference is taken 100mm above the knee

Code	Size (Height/Leg)	User Height (mm)	Leg Circ (mm)
PTA534100	X-Short / X-Small	to 1570	350 - 400
PTA534100XSS	X-Short / X-Small	to 1570	390 - 540
PTA534100SXS	Short / X-Small	1570 - 1640	350 - 400
PTA534100SS	Short / Small	1570 - 1640	390 - 540
PTA534100SL	Short / Large	1570 - 1640	520 - 590
PTA534100AXS	Average / X-Small	1650 - 1830	350 - 400
PTA534100AS	Average / Small	1650 - 1830	390 - 540
PTA534100AL	Average / Large	1650 - 1830	520 - 590
PTA534100TS	Tall / Small	1830 +	390 - 540
PTA534100TL	Tall / Large	1830 +	520 - 590

## Adult Full Leg - LO AFL

✓ DVA: AZ06



#### SIZING

- Determine user height first, and then take leg circumference to determine garment size
- Leg circumference is taken 20mm above cast/dressing or area to which protection is needed

Code	Size (Height/Leg)	User Height (mm)	Leg Circ (mm)
PTA534105	Short / Small	1530 - 1630	390 - 540
PTA534105SL	Short / Large	1530 - 1630	520 - 650
PTA534105AS	Average / Small	1650 - 1830	390 - 540
PTA534105AL	Average / Large	1650 - 1830	520 - 650
PTA534105TL	Tall / Large	1840 - 1960	520 - 650





### Cast & Bandage Protector

- Reusable, non-latex rubber diaphragm stretches easily over a cast or bandage creating a watertight seal
- Keep your cast dry whilst bathing or showering

Code	Description	Height	DVA:
BTS109100	Cast Protector - Short Arm	560 mm	AZ06
BTS109200	Cast Protector - Long Arm	990 mm	AZ06
BTS109300	Cast Protector - Short Leg	590 mm	AZ06
BTS109400	Cast Protector - Long Leg	1070 mm	AZ06
BTS109500	Cast Protector - Foot/Ankle	280 mm	AZ06



### Bath Sponge

- For bath or shower washing flexibility and independence
- Absorbent sponge attached to 24" long reaching stem and grip
- Allows easy reaching to the legs, feet and back
- Flexible enough to bend to any shape and reduces bending at the hip



### Bath Sponge Economy

- For bath or shower washing flexibility and independence
- Absorbent sponge with reaching handle
- Long handle to increase bathing independence
- Ideal for users with limited movement or trying to reduce bending at the hip

Code	Description	DVA:
BTS112800	Bath Sponge	AU08

Code	Description	DVA:
BTS111100	Bath Sponge Economy	AU08



### Toe Washer

- For washing and drying between the toes
- Long stem with plastic built up handle and a wire frame covered in a white towelling pad
- Designed to assist people with limited flexibility or access to their feet
- Includes 2 towelling pads



### Bath & Shower Mats

- Prevents slipping in the bath or shower
- Non slip rubber surface increases grip under foot
- Moulded suction cups on underside attach to bath or shower surface

Code	Description	DVA:
BTS113000	Toe Washer	AU10

Code	Description	Length	Width	Warranty
BTS110200	Bath Mat	580 mm	340 mm	1 Year
BTS109600	Shower Mat	530 mm	530 mm	1 Year



### eTAC Hair Washer

- For washing hair and making it easier to reach the head
- Prevents strain on hands, shoulders and arms
- Non-slip surface handles enables a secure grip

Code	Description	DVA:
DLG272301	eTAC Hair Washer	AU08





### Hand Held Shower Push On - Single

- Flexible shower head with single push on attachment assists showering
- Gentle flow shower head for sensitive skin
- High pressure clamp for attaching to tap
- Available in two lengths



Code	Description	Length	Warranty	DVA:
BTS114400	Hand Held Shower Push On - Single	1.25 m	1 Year	AZ02
BTS114500	Hand Held Shower Push On - Single	2 m	1 Year	AZ02



### Hand Held Shower Push On - Dual

- Flexible shower head with dual push on attachment for hot & cold assists showering
- Gentle flow shower head for sensitive skin
- High pressure clamp for attaching to tap
- Available in two lengths



Code	Description	Length	Warranty	DVA:
BTS114200	Hand Held Shower Push On - Dual	1.25 m	1 Year	AZ02
BTS114300	Hand Held Shower Push On - Dual	2 m	1 Year	AZ02



### Hand Held Shower

- Allows for ease of cleaning with its long flexible reinforced hose
- Can replace existing shower outlet or can be installed to allow use of both
- Extension hoses available
- Available in two lengths

Note: check suitability for fit, recommended to be installed by authorised service person



Code	Description	Length	Warranty	DVA:
BTS107200	Hand Held Shower 1.5	1.5 m	1 Year	AZ02
BTS107300	Hand Held Shower 2.0	2.0 m	1 Year	AZ02



### Hand Held Shower on Rail

- Attaches to an adjustable rail enabling the user to position the shower head as preferred
- Allows for ease of cleaning with its long flexible reinforced hose
- Replaces existing shower outlet, extension hoses available

Note: check suitability for fit, recommended to be installed by authorised service person



Code	Description	Length	Warranty	DVA:
BTS107500	Hand Held Shower On Rail	2000 mm	1 Year	AZ02



# Bathroom Trolleys

**I ♥ ndis** For NDIS Item Code, refer to page: 508



## Electric Mobile Shower Trolley

- Epoxy powder coated frame with curved base construction to allow easy access for carers
- Stainless Steel and P.V.C top frame with padded, vinyl mattress
- Electric tilt 8°, Electric Trendelburg Tilt, Electric high-low operation of 600 - 1000mm
- 125mm total lock castors for manoeuvrability and stability
- Plug-in rechargeable battery pack
- Ergonomic push handle and wall corner buffer discs

**2 Year Warranty**

Electrics

**5 Year Warranty**

Frame

Code	Description	Height	Width	Length	S.W.L	Warranty
BTS147100	Shower Trolley - Electric - Standard	600 - 1000 mm	730 mm	1890 mm	150 kg	2/5 Years
BTS147122	Shower Trolley - Extra Long	600 - 1000 mm	730 mm	2000 mm	200 kg	2/5 Years
BTS147124	Shower Trolley - Short	600 - 1000 mm	730 mm	1500 mm	200 kg	2/5 Years
BTS147126	Shower Trolley - Electric - Wide	600 - 1000 mm	900 mm	1890 mm	200 kg	2/5 Years
BTS147128	Shower Trolley - Electric - Wide Long	600 - 1000 mm	900 mm	2000 mm	200 kg	2/5 Years
BTS147110	Shower Trolley - Liner					
BTS147120	Shower Trolley - Pillow					
BTS147130	Shower Trolley - Hose Kit					
BTS147132	Shower Trolley - 125 mm Castors - Total Lock					
BTS147134	Shower Trolley - 125 mm Castors - Directional Lock					

## Electric Mobile Change Table



Optional Side Rails

- Epoxy powder coated frame base with curved base construction to allow easy access for carers
- Stainless Steel top frame with padded, heavy duty vinyl top
- Electric high-low operation of 600 - 1000mm
- Removable rechargeable battery pack
- Strap rail and wall corner buffer discs
- 125 mm total lock castors for manoeuvrability and stability

**2 Year Warranty**

Electrics

**5 Year Warranty**

Frame

Code	Description	Height	Width	Length	S.W.L	Warranty
BTS147140	Change Table - Mobile - Electric	600 - 1000 mm	610 mm	1825 mm	180 kg	2/5 years
BTS147150	Change Table Side Rail (One Side Only)					2/5 years
BTS147160	Change Table Chest Strap					2/5 years
BTS147170	Change Table Waist Strap					2/5 years

### DVA Contact Details

P 1300 888 052 | F 1300 787 052 | E [dva@aidacare.com.au](mailto:dva@aidacare.com.au)

**I ♥ ndis** For NDIS Item Code, refer to page: 508





## Aspire Hydraulic Shower Trolley

- Comfortable, padded and waterproof patient surface with welded seams for infection control
- Internal patient surface 1950mm x 600mm
- Height adjustable from 500mm to 775mm making sideways slide transfers a simple process
- Wall buffers promote durability and limit facility wear
- Durable stainless steel frame
- Hospital grade 125mm castors
- Central locking mechanism with directional lock functionality
- Integrated hydraulic Trendelenburg tilt function aids patient positioning and water drainage



Code	Description	Overall Height	Overall Width	Overall Length	S.W.L	Warranty
BTS148100	Aspire Hydraulic Shower Trolley	500 - 775 mm	840 mm	2150 mm	150 kg	2Years

## More From the Bathroom Range

<p>200 kg</p> <p>530mm Weight Bearing Platform Commode BTC066050</p>	<p>400 kg</p> <p>600mm Weight Bearing Platform Commode BTC061400</p>	<p>200 kg</p> <p>600mm Swing Away Footrest Commode BTC061300</p>	<p>350 kg</p> <p>Aspire Bariatric Shower Commode BTC062100</p>	<p>227 kg</p> <p>Bath Transfer Bench Bariatric BTS105300</p>
<p>310 kg</p> <p>Aspire MAXI Shower Chair BTS118020</p>	<p>310 kg</p> <p>Aspire MAXI Shower Stool BTS119030</p>	<p>310 kg</p> <p>Aspire MAXI Over Toilet Aid BTT145020</p>	<p>200 kg</p> <p>Aspire Shower Chair - Wide BTS118010</p>	<p>200 kg</p> <p>Raised Toilet Seat BTT149800</p>





# Bed Pans, Urinals & Bowls

**I ♥ ndis** For NDIS Item Code, refer to page: 508



## Wash Bowl

- Wash bowl is autoclavable for sanitising
- Moulded plastic construction
- Can also be used for bedside commodes

Code	Description	Capacity
WAT769800	Wash Bowl - 140 x 40 mm	600 ml
WAT770000	Wash Bowl - 210 x 40 mm	1500 ml
WAT761200	Wash Bowl - 305 x 90 mm	3500 ml
WAT769600	Wash Bowl - 345 x 120 mm	5500 ml



## Kidney Dish Plastic Disposable

- Kidney Dish range is used to hold dressings or instruments
- Available in a number of sizes
- Available in clear plastic disposable or green autoclavable for easy sanitising

Code	Description	Capacity
WAT770400	Kidney Dish Clear Plastic Disposable	700 ml
WAT770500	Kidney Dish Green Autoclavable	200 ml
WAT770600	Kidney Dish Green Autoclavable	600 ml
WAT770700	Kidney Dish Green Autoclavable	800 ml



## Spillproof Urinal

- Assists the user or carer in personal toileting creating more independence
- One-way valve prevents spilling
- Ideal for use while travelling or in the hospital or home

Code	Description	DVA:
BTT148200	Spillproof Male Urinal	AD04
BTT148300	Female Adaptor	AD04



## Male Urinal with Lid

- Assists the user or carer in personal toileting creating more independence
- Comes with lid to contain spillage
- Ideal for use in the hospital or home

Code	Description	DVA:
BTT148450	Male Urinal with Lid	AD04

### DVA Contact Details

P 1300 888 052 | F 1300 787 052 | E [dva@aidacare.com.au](mailto:dva@aidacare.com.au)

**I ♥ ndis** For NDIS Item Code, refer to page: 508





### Male Urinal

- Assists the user or carer in personal toileting creating more independence
- Ideal for use in the hospital or home

Code	Description	DVA:
BTT145700	Male Urinal - Green	-
BTT160900	Male Urinal - Clear	AD04



### Male Urinal with Screw Lid

- Assists the user or carer in personal toileting creating more independence
- Comes with screw on lid to contain and control spillage
- Ideal for use in the hospital or home

Code	Description	DVA:
BTT148400	Male Urinal with Screw Lid	AD04



### Female Urinal Cygnet

- Assists the user or carer in personal toileting creating more independence
- Anatomically designed to enable use while sitting, standing or lying
- Ideal for use in the hospital or home

Code	Description	DVA:
BTT148800	Female Urinal Cygnet	AD04



### Female Urinal

- Assists the user or carer in personal toileting creating more independence
- Anatomically designed to enable use while sitting, standing or lying

Code	Description	DVA:
BTT148700	Female Urinal	AD04



### Bed Pan

- Assists toileting of user whilst confined to bed, also may be used as a shower commode pan
- Wide seating area and front cut out to allow for correct positioning
- Made of a moulded plastic autoclavable construction

Code	Description	DVA:
BTT151800	Bed Pan	BE03

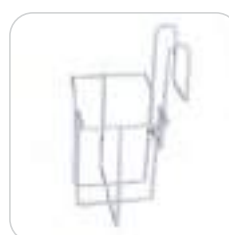

### Urinal Bottle Holder

- Urinal bottle holding device for quick storage and convenient access
- Nylon coated and fits easily onto the side of a bed

Code	Description	DVA:
BTT149000	Urinal Bottle Holder	AD04



### Bed Pan Slipper

- Assists toileting of an immobile user whilst confined to bed
- Wedge shape assists in positioning pan
- Made of a moulded plastic autoclavable construction

Code	Description	DVA:
BTT148000	Bed Pan Slipper - Small	BE03
BTT161500	Bed Pan Slipper - Large	BE03



### Aspire Commode Bowl with Handle and Lid

- Commode bowl and lid with handle for transportation
- Moulded plastic construction
- Compatible with Aspire Shower and Bedside Commodes

Code	Description	DVA:
BTC081610	Aspire Commode Bowl with Lid & Handle	BE03





# Grab Rails

I ♥ ndis For NDIS Item Code, refer to page: 508



## Grab Rails

- This high quality stainless steel grab rail range is available in a number of different sizes from 300 mm length through to 1200 mm to provide security and safety in the bathroom, on steps or any area where support is required. Designed with a 32mm diameter for a comfortable grip, these grab rails are available in either an anti-slip or white powder coated finish. They also feature concealed fixings.

Note: Check Suitability for Fit. Recommended to be Installed by an Authorised Service Person.



Code	Description	Length	Diameter	Warranty	DVA:
BTR102140	Grab Rail Anti Slip S.S. 300	300 mm	32 mm	1 Year	AL09
BTR102160	Grab Rail Anti Slip S.S. 450	450 mm	32 mm	1 Year	AL09
BTR102170	Grab Rail Anti Slip S.S. 600	600 mm	32 mm	1 Year	AL09
BTR102175	Grab Rail Anti Slip S.S. 750	750 mm	32 mm	1 Year	AL09
BTR102180	Grab Rail Anti Slip S.S. 900	900 mm	32 mm	1 Year	AL09
BTR102185	Grab Rail Anti Slip S.S. 1200	1200 mm	32 mm	1 Year	AL09
BTR102190	Grab Rail White Ripple S.S. 300	300 mm	32 mm	1 Year	AL09
BTR102191	Grab Rail White Ripple S.S. 450	450 mm	32 mm	1 Year	AL09
BTR102192	Grab Rail White Ripple S.S. 600	600 mm	32 mm	1 Year	AL09
BTR102194	Grab Rail White Ripple S.S. 900	900 mm	32 mm	1 Year	AL09

### DVA Contact Details

P 1300 888 052 | F 1300 787 052 | E [dva@aidacare.com.au](mailto:dva@aidacare.com.au)

I ♥ ndis For NDIS Item Code, refer to page: 508





### Grab Rails

- This high quality stainless steel grab rail range is available in a number of different sizes from 300mm length through to 1200mm to provide security and safety in the bathroom, on steps or any area where support is required. Designed with a 32mm diameter for a comfortable grip, these grab rails are available in either an anti-slip or white powder coated finish. They also feature concealed fixings.

Note: Check Suitability for Fit. Recommended to be Installed by an Authorised Service Person.

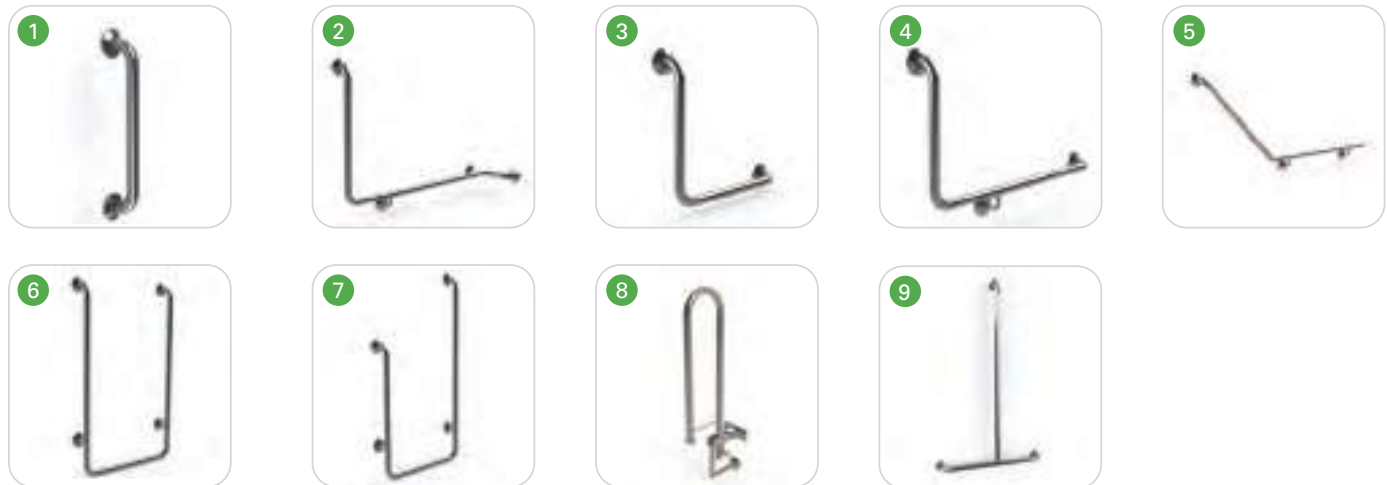

Code	Part	Description	Length	Width	Height	Diameter	Warranty	DVA:
<b>Straight Rail (Concealed Flange)</b>								
1	BTR103100	4H0 Grabrail - 300mm - Straight	300 mm	-	-	32 mm	5 Years	AL09
	BTR103120	4H2 Grabrail - 600mm - Straight	600 mm	-	-	32 mm	5 Years	AL09
<b>L Shape Rail (Concealed Flange)</b>								
2	BTR103170	4H5R Grabrail - L Shape with 90 Degree Return - Right Hand	1020 mm	220 mm	600 mm	32 mm	5 Years	AL09
	BTR103180	4H6L Grabrail - L Shape - Left Hand	600 mm	-	600 mm	32 mm	5 Years	AL09
3	BTR103190	4H6R Grabrail - L Shape - Right Hand	600 mm	-	600 mm	32 mm	5 Years	AL09
	BTR103195	4H6S Grabrail - L Shape - Right Hand - Short	450 mm	-	450 mm	32 mm	5 Years	AL09
	BTR103200	4H7L Grabrail - L Shape + Additional Off Stand - Left Hand	800 mm	-	600 mm	32 mm	5 Years	AL09
4	BTR103210	4H7R Grabrail - L Shape + Additional Off Stand - Right Hand	800 mm	-	600 mm	32 mm	5 Years	AL09
	BTR103230	4H9L Grabrail - L Shape - No End Return - Left Hand	1020 mm	-	600 mm	32 mm	5 Years	AL09
	BTR103240	4H9R Grabrail - L Shape - No End Return - Right Hand	1020 mm	-	600 mm	32 mm	5 Years	AL09
	BTR103262	4H10L Grabrail - 45 Degree - Left Hand	920 mm	-	720 mm	32 mm	5 Years	AL09
5	BTR103264	4H10R Grabrail - 45 Degree - Right Hand	920 mm	-	720 mm	32 mm	5 Years	AL09
<b>U Shape Rail (Concealed Flange)</b>								
6	BTR103220	4H8 Grabrail - U Shape	600 mm	-	1050 mm	32 mm	5 Years	AL09
	BTR103225	4H8S Grabrail - U Shape - Short	600 mm	-	600 mm	32 mm	5 Years	AL09
	BTR103300	4H12L Grabrail - U Shape - Left Hand Au Std	750 mm	-	1150 mm	32 mm	5 Years	AL09
7	BTR103310	4H12R Grabrail - U Shape - Right Hand Au Std	750 mm	-	1150 mm	32 mm	5 Years	AL09
<b>Swing Up Rail (Concealed Flange)</b>								
8	BTR103270	4H11L Grabrail - Swing Up - Left Hand	846 mm	-	222 mm	32 mm	5 Years	AL09
	BTR103280	4H11R Grabrail - Swing Up - Right Hand	846 mm	-	222 mm	32 mm	5 Years	AL09
<b>"T" Type Shower Rail (Concealed Flange)</b>								
	BTR103250	4H20L "T" Type - Grab/Shower Rail - Left Hand	600 mm	-	1100 mm	32 mm	5 Years	AL09
9	BTR103260	4H20R "T" Type - Grab/Shower Rail - Right Hand	600 mm	-	1100 mm	32 mm	5 Years	AL09
<b>Optional Extras</b>								
	BTR103340	4H15K Fixing Kit for Grabrails - Per Flange (SS SelfTapers and Plugs)					5 Years	AL09





### Throne Grab Rail

- Attaches firmly to the toilet bowl, independent of wall or floor support
- Adjustable mounting brackets to allow for correct fitting to different size toilets
- Grab rail support frame enables secure access toileting and promotes user independence whilst assisting carers



Code	Description	DVA:
BTT157100	Throne Grab Rail Powder Coated - 3 in 1	BE06
BTT157101	Throne Grab Rail Stainless Steel - 3 in 1	BE06
BTT157106	Throne Grab Rail Wraparound Stainless Steel	BE06
BTT157116	Throne Spacer Bracket	BE10
BTT157110	Throne Spacer 50 mm	BE10
BTT157115	Throne Spacer 80 mm	BE10



### Toilet Safety Arms - Darts

- Provides standing / lowering assistance for people with sore joints or bending difficulty
- Bolts to toilet using existing seat fixing points
- Swing back independent armrests
- Quality stainless steel construction



Code	Description	Width	Height	Armrest Height (From Seat)	S.W.L	DVA:
BTT151200	Toilet Safety Arms, Darts	580 mm	360 mm	360 mm	100 kg	BE06



### Devon MKII Folding Support Rail

- Baseplate securely mounted on the wall, rail is held upright by a spring loaded cam and folds down when not in use
- Optional toilet roll holder
- A deluxe version of the Devon rail with a large diameter rail for easier gripping

Note: Check Suitability for Fit. Recommended to be Installed by an Authorised Service Person.



Code	Description	Rail Length	Product Weight	S.W.L	Warranty	DVA:
BTT149400	Devon MKII Folding Support Rail	760 mm	4.1 kg	84 kg	1 year	AL09
BTT149700	Toilet Roll Holder				1 year	AL09



### Devon Rail with Folding Leg

- Support leg gives strength and stability during lowering and raising, lessening strain on the wall
- Fully adjustable height leg (790 - 985 mm) and has a large non slip ferrule

- Baseplate securely mounted on the wall, rail is held upright by a spring loaded cam and folds down when not in use

Note: Check suitability for fit. Recommended to be installed by an authorised service person.



Code	Description	Rail Length	Product Weight	S.W.L	Warranty	DVA:
BTT149500	Devon Rail with Folding Leg	760 mm	5 kg	67 kg	1 year	AL09
BTT149600	Devon Rail - Floor Mounted				1 year	AL09



### Bathtub Grab Rail

- Bathtub Grabrail provides a firm handle at the bath side for user confidence and stability
- Increases safety during transfers
- Rubber pads for security and protection
- Adjustable clamps to suit a large range of tub sizes and edges



Code	Description	Height	Depth	Product Weight	S.W.L	Warranty	DVA:
BTS108100	Bathtub Grab Rail	680 mm	300 mm	3 kg	190 kg	1 Year	AL09



### Canterbury Concepts Modular Rails

- Canterbury Concepts rails comply with Australian Standard AS1428.1 - Design for access and mobility
- When installed correctly rails can withstand 1100 N or 110 kg
- Rails feature a unique slip resistant surface
- Modular design allows easy configuration to any household



### Common Configurations

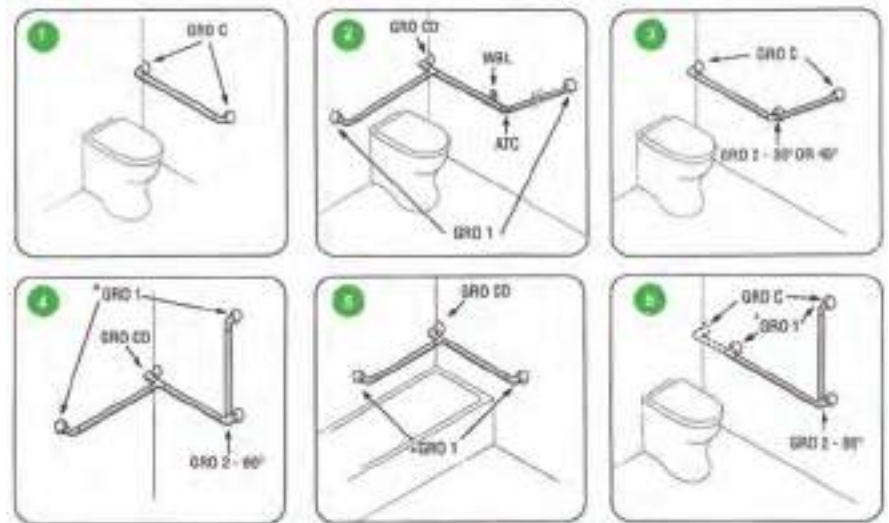

### Ordering Example

To order configuration 4:

- 1 x BTR101720 (Rail Elbow & Wall Flange)
- 1 x BTR101770 (One T-piece, one wall flange with washer & screw)
- 1 x BTR101880 (Internal Corner fitting, one corner wall flange)
- 3 x BTR101850 (900 mm Grab Rail complete with Multi Point End Set)



Code	Part	Description	Code	Part	Description
<b> Tubes </b>			<b> Fixing </b>		
BTR101805	GR03	Rail 300mm, Tube 32mm Diameter	BTR101810	GR03W	3 Way Fitting, Wall Flange Includes Fixings
BTR101820	GR04.5	Rail 450mm, Tube 32mm Diameter	BTR101830	GR04W	4 Way Fitting, Wall Flange Includes Fixings
BTR101840	GR06	Rail 600mm, Tube 32mm Diameter	BTR101890	GT	Gravity Toggles Large or Small with Centring Sleeve
BTR101850	GR09	Rail 900mm, Tube 32mm Diameter	<b> Fittings </b>		
BTR101740	GR012	Rail 1200mm, Tube 32mm Diameter	BTR101770	GR02	One T-piece, One Wall Flange with Washer & Screw
BTR101750	GR015	Rail 1500mm, Tube 32mm Diameter	BTR101880	GR0CD	Internal Corner Fitting, One Corner Wall Flange
<b> Bends &amp; Elbows </b>			<b> Accessories </b>		
BTR101780	GR02/30	One 30 Deg Bend, One Wall Flange with Fixings	BTR101884	PEB	50mm Diam. End Ball for Stop Ending Handrails
BTR101790	GR02/45	One 45 Deg Bend, One Wall Flange with Fixings	BTR101959	MP900	900mm Grab Rail Complete with Multi Point End Set
BTR101800	GR02/90	One 90 Deg Bend, One Wall Flange with Fixings	BTR101963	CR	Connector Ring
BTR101965	E30 & WBL	30 Degree Bend with WBL	BTR101961	ER	End Ring
BTR101966	E45 & WBL	45 Degree Bend with WBL	BTR101882	HH	Handset and Hose
BTR101967	E90	90 Degree Tube Connector Not Elbow	BTR101962	LER	Large End Ring
BTR101964	PB	Pipe Bend	BTR101968	LAR	Lift Away Rail
BTR101870	GR0C2	Rail Elbow & Crn Flange 2Pk	BTR101969	LAR & SL	Lift Away Rail with Support Leg
BTR101860	GR0C	Rail Elbow & Std Flange Cnr Flange	BTR101420	ATC&WBL	Multi Angle Fittings for Tubes
BTR101720	GR01	Rail Elbow & Wall Flange	BTR101960	MP	Multi Point End Set
BTR101760	GR01SL	Two Elbows. Two Slimline Flanges with Fixings	BTR101883	PE	Plug for End of Tube
			BTR102930	SS	Rail Shower Slide
			BTR101881	TRH	Toilet Roll Holder with Fixing for Grabrail or Wall
			BTR102200	TC	Tube Connector



## Suction Grab Rails

- This range of suction grab rails are lightweight and portable, featuring a durable commercial grade suction cup making them the strongest in the market. Easy to install and remove without any tools, the suction grab rails come in a range of standard, telescoping and pivot grip.

Note: Check Suitability of Surface Before Use. Not Suitable for All Surfaces.



Code	Description	Length	Warranty
BTR102201	Suction Grab Rail	330 mm	1 Year
BTR102202	Suction Grab Rail - Medium Telescoping	480 - 610 mm	1 Year



## Specialty Toilet Rails

- This range of Specialty Toilet Rails have a number of various configurations of rail length and mountings to suit the requirements of each toilet configuration. These high quality stainless steel rails are manufactured from 32mm diameter 1.2mm gauge heavy grade T304 polish tube. Flanges are five holed (75 mm dia x 2.5mm thick) and are fully welded on the underside of the flange, forming an extremely strong, clean and hygienic product. Standard wall clearance is 60 mm ensuring compliance with AS1428.1:2001. All rails are manufactured with an electro polished finish as standard. Alternatively you can request a satin or epoxy coated finish depending on your decor requirements - specify at time of order.



Code	Description	Length	Warranty
BTR101925	Grab Rail Type 05 - Left Hand 45 Degree Bend	600 mm Sections	1 Year
BTR101926	Grab Rail Type 05 - Right Hand 45 Degree Bend	600 mm Sections	1 Year
BTR101930	Grab Rail Type 06 - Right Hand 45 Degree Bend	1400 mm Sections	1 Year



For Bedside  
Commodes  
Refer to Page 78

CONTACT US  
FOR A BROCHURE



 aidacare FL250  
FL250 FLOORLINE BED



Low Height, High Style



# Bedroom

# Contents

- P 062 Home Care Beds
- P 066 Aged Care Beds
- P 070 Mattress Overview
- P 071 Mattress Safety, Support & Protection
- P 072 Underlays & Overlays - Foam
- P 073 Mattresses - Foam
- P 078 Mattresses - Alternating Air
- P 080 Mattresses - Other
- P 081 Bedside Commodes
- P 083 Overbed Tables
- P 086 Bedroom Furnishings
- P 089 Bed Sticks, Bed Poles & Other
- P 092 Pillows & Supports
- P 094 Sleep Positioning Aids
- P 096 Falls Prevention & Alarms



# Home Care Beds



For NDIS Item Code, refer to page: 508

Brochures also available. Please contact us for a copy.



## BED COLLECTION

The Aspire ComfiMotion Collection comprises of electrically operated Beds offering functions and positional movements that assist users and maximise comfort and safety. Ease of use, functionality, serviceability and cleaning practicality are key features of the bed. The beds have a luxurious padded frame overlaying the durable powder coated finish.

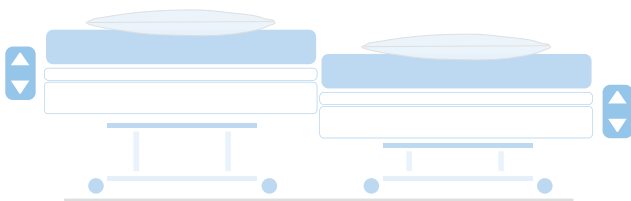

### Dual Adjustable Beds

Designed to sit flush when positioned together to enable close monitoring and enhanced care. This configuration offers the flexibility of independent adjustability, without compromising on the sense of inclusivity and intimacy between partners.

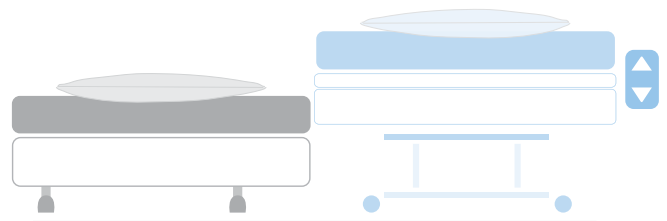

### Fixed Companion Bed

Matching single bed without any adjustability designed to sit flush when positioned together. It facilitates a side-by-side sleeping arrangement at a fixed height of 370mm, without compromising on the users care and assistance requirements.

## Aspire ComfiMotion Fixed Companion Bed

Code	Overall Length	Overall Width	Overall Height
BEB046800 (LONG SINGLE)	2030mm	920mm	370mm

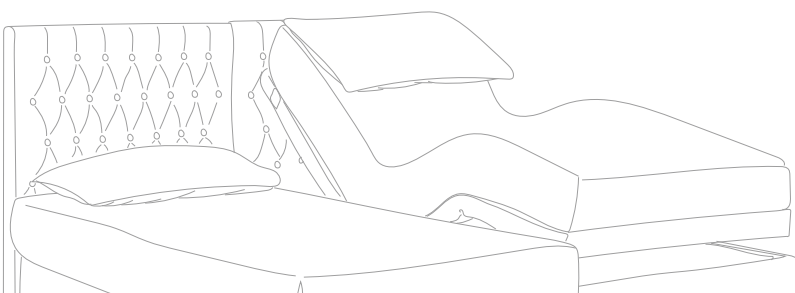

### General Enquiries

P 1300 133 120 | E sales@aidacare.com.au | W www.aidacare.com.au



## Aspire Comfirmotion Luxe Bed

### LUXE Functions

**Head Tilt:** Relaxes neck muscles, providing optimal support whilst reading or watching TV.

**Memory Function:** Allows the user to set and return to their preferred positions at any time with one click of a button.

**Hi-Lo functionality:** Assists with bed entry and exit by raising the mattress surface to the ideal height.

**Back Raise:** Improves postural support and can ease symptoms of reflux, respiratory conditions, snoring and sleep apnoea.

**Leg Raise:** Promotes circulation, relieving tired, swollen and/or painful limbs.

**Zero Gravity:** Helps to relax the circulatory system and muscles of the lower back.

### LUXE Features

- Relaxing vibration modes for personalised neck, shoulder and back relief.
- Hand control allows users to find their perfect position to maximise comfort and relaxation.
- Luminous underbed halo for safe entry and exit throughout the night.
- Box-on-box design facilitates easier entry and exit and allows true flush positioning of beds in companion or dual adjustable bed configurations.
- Connect and charge your devices conveniently with the USB port.
- German engineered motors for smooth, quiet adjustment



LUXE  
HANDSET

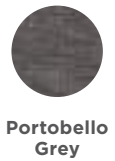
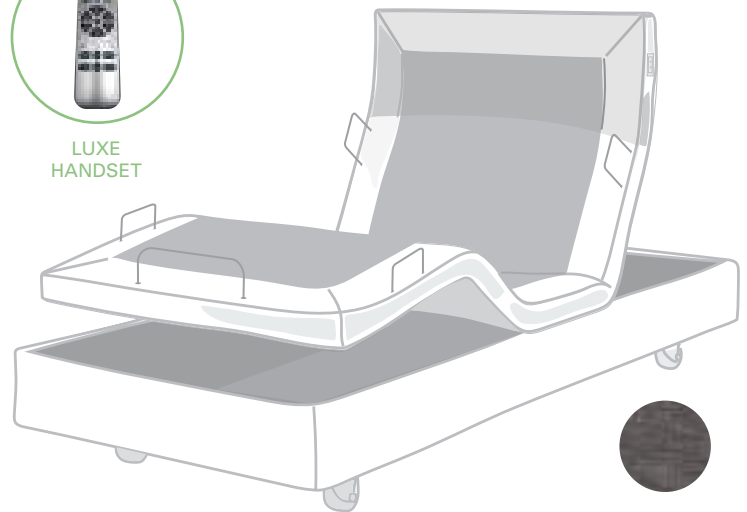

Handset



Electronics



Frame



Code	Overall Length	Overall Width	Height Range available from min to max: 255 - 660mm	SWL
BEB046710 (KING SINGLE)	2030mm	1070mm	*with fixed feet, min height is 255mm	180kg
			*with 75mm castors, min height is 330mm	
			*with 125mm castor accessibility kit, min height is 380mm	



### DVA Contact Details

P 1300 888 052 | F 1300 787 052 | E [dva@aidacare.com.au](mailto:dva@aidacare.com.au)



For NDIS Item Code,  
refer to page: 508





## Aspire Comfimation Care Bed

### CARE Functions

**Hi-Lo functionality:** Assists with bed entry and exit by raising the mattress surface to the ideal height.

**Back Raise:** Improves postural support and can ease symptoms of reflux, respiratory conditions, snoring and sleep apnoea.

**Leg Raise:** Promotes circulation, relieving tired, swollen and/or painful limbs.

**Zero Gravity:** Helps to relax the circulatory system and muscles of the lower back.

**Clinical Positioning:** One touch raises back and legs to alleviate cardiac exertion, improving resting comfort.

**Seated Position:** Assists with bed entry and exit and upright dining.

**Trendelenburg (and Reverse):** Can assist care givers when repositioning a user\*.

*\*Carers should seek advice from a trained Allied Health professional for correct manual handling techniques.*

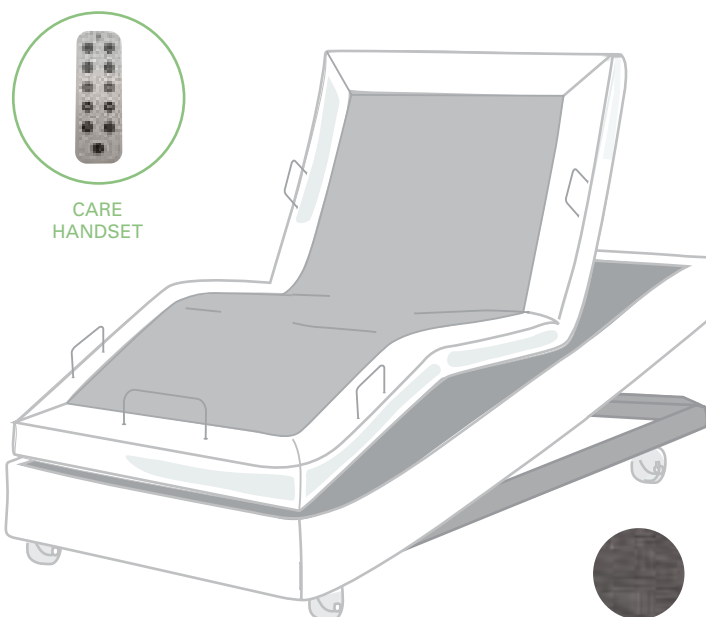

CARE  
HANDSET

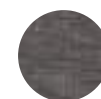

Portobello  
Grey

### CARE Features

- Night Assist: Luminous underbed halo for safe entry and exit throughout the night.
- Press and hold safety handset: Intuitive, large button interface enhances usability.
- Enclosed frame design: Ensures optimal positioning when getting into bed and safely covers the moving base platform.
- Safe-Lowering Technology: Ensures that back, leg and Hi-Lo functions only lower under the force of gravity reducing potential for accidents or injuries.
- Box-on-box design facilitates easier entry and exit and allows true flush positioning of beds in companion or dual adjustable bed configurations.
- German engineered motors for smooth, quiet adjustment.



Handset



Electronics



Frame



Code	Overall Length	Overall Width	Height Range available from min to max: 255 - 660mm	SWL
BEB046720 (LONG SINGLE)	2030mm	920mm	*with fixed feet, min height is 255mm	180kg
			*with 75mm castors, min height is 330mm	
			*with 125mm castor accessibility kit, min height is 380mm	
BEB046730 (KING SINGLE)	2030mm	1070mm	*with fixed feet, min height is 255mm	180kg
			*with 75mm castors, min height is 330mm	
			*with 125mm castor accessibility kit, min height is 380mm	

*\*Please refer to Aspire Comfimation Bed Collection User Manual for recommended mattress sizes and bed weight*

*\*Please refer to pg.73 to see 'Pocket Spring Mattress' & 'Memory Foam Mattress' suited to the Comfimation Bed Collection*

### Accessories

BEA830120 (LONG SINGLE)  
BEA830130 (KING SINGLE)



CHESTERFIELD HEADBOARD  
(ACCESSORY)

BEA830100 (LONG SINGLE)  
BEA830110 (KING SINGLE)



ALLURE HEADBOARDS  
(ACCESSORY)

BEA830220



BATTERY  
BACK UP

MWT451080  
(4 X REQUIRED)



BED  
CASTORS

BEA830200



CROOK HANDLE  
BED STICK

BEA830200

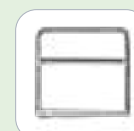

BED  
RAIL

### General Enquiries

P 1300 133 120 | E sales@aidacare.com.au | W www.aidacare.com.au





## Aspire Community Care Bed



A simple yet stylish, electronically controlled bed for aged care or home environments. Made of solid construction, the Community Care bed enables both care giver and patient to reposition the bed for most aspects of care.

TiMotion Electronics



Integrated Bed Extension

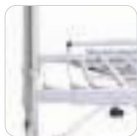

Four Total-Lock Castors



Self-help Pole



Mattress Retainers



Large Lifting Range



### HIGHLY ADJUSTABLE

Five electric profiling functions to suit all comfort and positioning needs:

Recommended mattress:  
Lifecomfort Deluxe AC (BEM046510)

- High Low
- Backrest (60°)
- Knee Bend (30°)
- Trendelenburg (10.5°)
- Combined Backrest Knee Bend
- Warranty:
  - Frame: 3 Years
  - Electronics: 2 Years
  - Handset: 1 Year



### Optional Accessories



DVA: AT12  
IV Pole  
BEA016592



DVA: AB16  
Transport Kit  
BEA029870



DVA: AB09  
Shroud Ends - Beech  
BEA029845



DVA: AB09  
Side Rails - Beech  
BEA029865  
Side Rails Extended  
Length - Beech

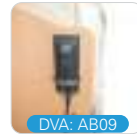

DVA: AB09  
Handset Holder Bracket  
- BEA030030

Code	Description	External Length	External Width	Bed Height Range	Mattress Dimensions	Mattress Platform Length	S.W.L	DVA:
BEB046050	Community Care Bed - 4 Function	2140 - 2240 mm	1025 mm	220 - 710 mm	2000 x 900 mm	2020 - 2120 mm (25 mm increments)	180 kg	AB01

## Homecare Comfi Bed



- Electrically adjustable Hi/Lo homecare bed - height range 220 - 660mm
- Padded bed surround creates contemporary décor look
- Allows users the function of an adjustable bed within their own home
- Head lift & knee break
- Single, King Single and Companion beds and mattresses combinations available
- The Companion Bed is suitable for parents, partners or caregivers

DVA: AB01



### DVA Contact Details

P 1300 888 052 | F 1300 787 052 | E [dva@aidacare.com.au](mailto:dva@aidacare.com.au)



For NDIS Item Code, refer to page: 508

# Aged Care Beds



For NDIS Item Code, refer to page: 508



Brochures also available. Please contact us for a copy.

**aidacare** FL250



## FL250 Floorline Bed

- 110mm Low Height / 740mm Max Height
- Four Section Wipe Clean Mattress Platform
- Powered Backrest 0 - 60°, Powered Knee Break 0 - 35°
- Auto-Regression in Backrest and Knee Break
- Trendelenburg / Reverse Trendelenburg
- Underbed Lighting for Falls Prevention
- Intelligent Wall Protection Buffer
- Integrated Bed Extension to 100mm and 200mm
- One Button Chair Positioning
- One Button Optimum Ingress / Exit and CPR
- Foot-end control panel

### Standard Bed Ends (sold separately)

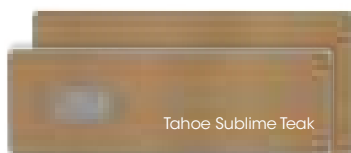

### Made to Order Bed Ends



**Tallo**  
Timber or laminate surround and recessed timber veneer inner with a straight gap detail.



**Eyre**  
Timber or laminate surround and recessed timber veneer inner with a curved gap detail.



**Como**  
Timber or laminate surround and recessed timber veneer inner.



**Sophia**  
Timber surround with upholstered inner detail on headboard and recessed timber veneer detail on footboard.

General Enquiries

P 1300 133 120 | E sales@aidacare.com.au | W www.aidacare.com.au



## Aidacare FL250 Floorline Bed



One Button Chair Positioning

Optimum Ingress / Exit and CPR Height



Powered Backrest from 0 - 60°

Powered Knee Break from 0 - 35°

Integrated Bed Extension of 100mm and 200mm

Underbed Clearance Minimum of 30mm

Underbed Lighting for Falls Prevention



Four Section Wipe Clean Mattress Platform

110mm Low Height, 740mm Max Height

Auto-Regression in Backrest and Knee Break for Shear-Force Reduction

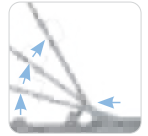

Handset and Attendant Control Panel - Both Backlit and Lockable

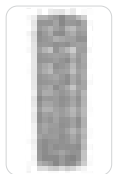

In-line Central Locking Brakes, and 8 x 75mm Twin Castors

Intelligent Wall Protection Buffer

Mattress Retainers at Sides / Foot End

Trendelenburg / Reverse Trendelenburg

Auto Locking Brakes

### Full Range of Performance Enhancing Accessories



Easy Move Transport System  
BEA030050



Split Folding Side Rails  
BEB046525



Folding Assist Bar  
BEB046520



Self Help Pole  
BEB046540



IV Pole  
BEB046530



Battery Backup  
BEB046590



Width Extension Kit  
BEB046500



### Standard Bed Ends and Side Panels



Tahoe Sublime Teak



Vail Milano Walnut



Sublime Teak



Milano Walnut



Tallo



Eyre



Como



Sophia

### Made to Order Bed Ends

**Customisable Finishes** - Customise to suit your interior design specifications or desires - timber, veneer, laminate, fabric, upholstery, any colours, shapes and sizes.

Code	Description	Mattress Dimensions	Overall Width	Overall Length	Length Extension	Product Weight	S.W.L
BEB046100	FL250 Floorline Bed - Single	2000 x 900 mm	900 mm	2088 - 2288 mm	100 - 200 mm	105 kg	250 kg
BEB046150	FL250 Floorline Bed - King Single	2000 x 1060 mm	1060 mm	2088 - 2288 mm	100 - 200 mm	115 kg	250 kg

### Bed End Sets with Attendant Control Panel (Sold Separately)

Code	Description
BEB046200	Bed End Set - Single - Tahoe (Sublime Teak)
BEB046210	Bed End Set - Single - Vail (Milano Walnut)
BEB046220	Bed End Set - King Single - Tahoe (Sublime Teak)
BEB046230	Bed End Set - King Single - Vail (Milano Walnut)

### Bed Side Panels - Choose Appropriate Size Attachment Hardware

Code	Description
BEB046240	Bed Side Panels - Tahoe (Sublime Teak) - Hardware separate
BEB046250	Bed Side Panels - Vail (Milano Walnut) - Hardware separate
GSP391630	Bed Side Panels Attachment Hardware - Single Bed
GSP391640	Bed Side Panels Attachment Hardware - King Single Bed



## Aidacare AC2 & AC3 Beds



Leading Quality  
Frame & Electronics

Removable Laminate Bed Ends



Integrated Bed Extension



Central Locking (3 function only)



Removable Mattress Platform



Easy Access Control Box



Cable Management



EXTENDABLE  
MATTRESS RETAINER

### CONFIGURATIONS:

- Three models available
- AC2 - 2 Function Single - Electric high/low and backrest (70°)
- AC3 - 3 Function Single & King Single Electric high/low, backrest (70°) and knee bend (35°)
- Recommended mattresses: Lifecomfort AC Series - Regular, Deluxe or Pressure Reducing

### Optional Accessories



DVA: AB09  
Folding Side Rails  
BEA029700



DVA: AT12  
IV Pole  
BEA029710



DVA: AB12  
Self Help Pole  
BEA029705

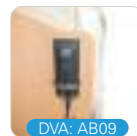

DVA: AB09  
Handset Holder Bracket  
- BEA030030



1  
Year  
Warranty

Handset



3  
Year  
Warranty

Electronics



10  
Year  
Warranty

Frame



IDEAL FOR  
HOME USE



S.W.L  
220kg

Code	Description	External Length	External Width	Bed Height Range	Mattress Dimensions	Safe Working Load	DVA:
BEB045901	AC2 Single Bed - 2 Function	2120 mm	920 mm	285 - 685 mm	2000 x 900 mm	220 kg	-
BEB045900	AC3 Single Bed - 3 Function	2120 mm	920 mm	285 - 685 mm	2000 x 900 mm	220 kg	-
BEB045905	AC3 King Single Bed - 3 Function	2140 mm	1090 mm	285 - 685 mm	2030 x 1050 mm	220 kg	AB01



## Bariatric Bed - 350kg

- 2, 3 or 4 function bed options
- Available optional timber surround
- Rounded corners minimise wall damage & maximise OH&S is safety
- 100 mm twin castors, or central locking (CL) 125 mm twin castors available
- Nurse lockout on hand control

- 10 years warranty on structural frame
- 5 years warranty on electronics
- 150mm Lifter clearance

### CONFIGURATIONS:

Recommended mattress: Lifecomfort Deluxe AC (BEM046510)

Code	Description	Ext Length	Ext Width	Bed Height Range	Mattress Dimensions	S.W.L	Warranty
BEB045070	Bariatric (350) King Single - 2 Function	2120 mm	1070 mm	260 - 750 mm	2030 x 1050 mm	350 kg	10yr/5yr
BEB045080	Bariatric (350) King Single - 3 Function	2120 mm	1070 mm	260 - 750 mm	2030 x 1050 mm	350 kg	10yr/5yr
BEB045085	Bariatric (350) King Single - 4 Function	2120 mm	1050 mm	260 - 750 mm	2030 x 1050 mm	350 kg	10yr/5yr

### Bed Accessories List

BEA016493	Central Locking 125mm Twin Castor Wheels
BEA016495	IV Pole
BEA016500	Self Help Pole
BEA016530	Battery Back Up
BEA016520	Underbed Lighting
BEA016540	Base Extension 250mm
BEA016550	Wall Buffers - (Set of 4)
BEA016570	Bed Head/Footboard - Woodgrain Laminate



### General Enquiries

P 1300 133 120 | E sales@aidacare.com.au | W www.aidacare.com.au



Low Height Position

## Contego Floorline Folding Bed

- Floor bed lowers to within 110mm off the floor for safety and access in aged care
- Fully height adjustable with Trendelenburg tilt (15°) for drainage and positioning
- 75° Backrest and 30° Kneebend
- Lightweight, dismantle frame for easy transportation
- Integrated cable management to suit all alternating air mattress systems
- Removable head and footboards

- 100mm castors
- Standard single bed or king single bed extension available
- Mattress retainers are included

### CONFIGURATIONS:

Recommended mattresses:

Lifecomfort Deluxe AC (BEM046510) or Lifecomfort Deluxe King Single (BEM046455)



Optional Side Rails



Antifall Floor Rail System

Code	Description	External Length	External Width	Bed Height Range	Mattress Dimensions	S.W.L	Warranty	DVA:
BEB049500	Contego Floorline - Aged Care Bed - 4 Section + Patient Retaining System	2250 mm	920 mm	110 - 710 mm	1950 x 880 mm	225 kg	3/10 Years	AB01

## Contego Floorline Bed Accessories/Options

BEA824100	Contego King Single Extension (Must be Factory Fitted)						3/10 Years	AB16
BEA824105	Contego Bed Side Rails - Pair						3/10 Years	AB09
BEA824125	Contego Bed Wall Bumper						3/10 Years	AB16
BEA824127	Contego Bed Extension 100 mm						3/10 Years	-
BEA824126	Contego Bed Extension 250 mm						3/10 Years	-
BEA824128	Contego Bed Storage and moving frame						3/10 Years	-
MBT40210	Portable Power Supply							



## Careline Huntington's Bed - Electric

Made in Germany, the Careline Huntingtons bed is of the highest quality. The beds are sturdy in construction and built to resist constant movements by the user. The mattress is also waterproof and designed to reduce the risk of shearing.

The bed offers high low functions, backrest and leg support in addition to being fully padded for the protection of the user. This padding extends to the head and footboards and also the rails are padded.

The padded rails are electrically operated to minimise risk to users and also carers. The castors are lockable by a foot control.

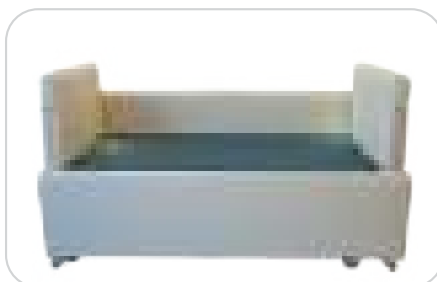
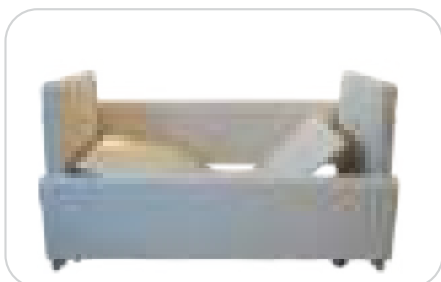

- Fully padded at head, feet and sides
- Rounded edges
- Padded sides are electronically powered
- No gaps to ensure limbs do not get caught
- Robust, waterproof vinyl covers
- German made
- Hi-Lo electrically adjustable bed
- Suitable for Community and Nursing homes

Code	Description	External Width	Bed Height Range	Mattress Dimensions	Backrest Incline/Decline	Knee Bend Incline/Decline	S.W.L
BEB046010	Huntington's Bed - Electric	900 - 1100 mm	430 - 610 mm	2000 x 900 mm	0 - 55°	0 - 40°	150 kg

### DVA Contact Details

P 1300 888 052 | F 1300 787 052 | E [dva@aidacare.com.au](mailto:dva@aidacare.com.au)



For NDIS Item Code, refer to page: 508

# Mattress Overview



For NDIS Item Code, refer to page: 508

Brochures available. Please contact us for a copy.



## Pressure Care Mattress Selection Guide

- L** Low Risk - *Comfort*
- M** Medium Risk - *Prevention Management*
- H** High Risk - *Prevention & Recuperation Management*
- V** Very High Risk - *Prevention & Recuperation Management*

Bony prominences that can cause pressure injuries include:

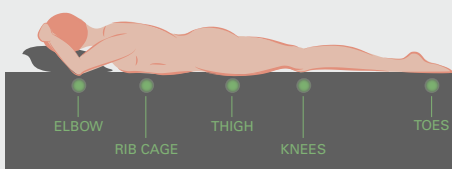
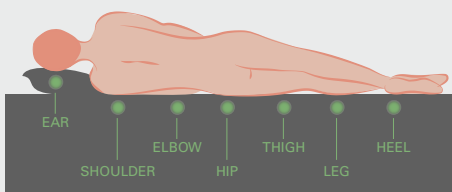
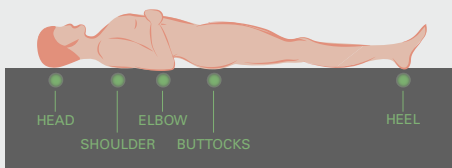

	Pg
<b>Mattress Safety, Support &amp; Protection</b>	
<b>L</b> • Lifecomfort Fall Safety Mat .....	71
• Lifecomfort Evacuation Sheet .....	71
• Mattress Protector Sheets.....	71
<b>Underlays &amp; Overlays - Foam</b>	
<b>L</b> • Lifecomfort Pressure Safety Underlay .....	72
• General Overlays.....	72
<b>Mattresses - Foam</b>	
<b>L</b> • Comfimation Classic Memory Foam.....	73
• Comfimation Classic Pocket Spring.....	73
• Lifecomfort Standard.....	74
• Lifecomfort with Safety Sides.....	74
• Lifecomfort Deluxe.....	75
<b>M</b> • Lifecomfort Pressure Reducing.....	75
• Lifecomfort Premier Care.....	75
• Lifecomfort Premier Acute Care .....	75
• Lifecomfort Acute Care.....	76
• Lifecomfort Bariatric.....	76
• Lifecomfort with ROHO® Insert.....	76
• Lifecomfort Extension Bolster.....	77
<b>H</b> • ROHO® Mattress Sections.....	77
<b>Mattresses - Alternating Air</b>	
<b>H</b> • Lifecomfort Hybrid Mattress Systems.....	78
• Lifecomfort Hybrid Acute.....	78
• Lifecomfort Active Air 4 Mattress Overlay.....	78
• Lifecomfort Active Air 5 Mattress Overlay.....	78
• Lifecomfort Active Air 8 Mattress Replacement.....	79
<b>V</b> • Lifecomfort Active Air Acute 8 Mattress Replacement.....	79
• Lifecomfort Active Air Bari 10 Mattress Replacement .....	79
<b>Mattresses - Other</b>	
<b>L</b> • Concave Positioning Cover .....	80
<b>M</b> • Softform Maxi Glide .....	80
<b>H</b> • Softform Premier Active.....	80



### Lifecomfort Fall Safety Mat

- Designed to reduce the risk of injury, particularly the risk of head injury, when a person rolls out of bed
- The non-slip underside prevents accidental movement of the mat
- The reflective strip minimises the risk of tripping when used in low light
- When not in use, it can be easily folded for convenient and compact storage



Foam



Cover



Code	Description	Height	Width	Length	DVA:
BEA008550	Fall Safety Mat	50 mm	600 mm	1760 mm	AB16



### Lifecomfort Evacuation Sheet

Designed for the emergency evacuation of the non-ambulant person, the Aidacare Lifecomfort Evacuation Sheet:

- Fits discreetly underneath the resident's mattress
- Allows bed making to occur as normal
- Remains readily accessible in case of emergency evacuation
- Is fire retardant and highly durable

- The Evacuation Sheet was designed to help rescue teams, carers or nurses to slide the mattress and resident along any floor surface or even downstairs, increasing resident safety and preventing injury to nursing staff



Code	Description	Width	Length	DVA:
TSE672526-S	Evacuation Sheet - Single	720 mm	1900 mm	AB13
TSE672526	Evacuation Sheet - King Single	900 mm	1900 mm	AB13

### Mattress Protector Sheets



Bed Pad Deluxe  
CON228600  
(Refer to Page 122)



Protect A Plus  
BEM047682  
(Refer to Page 123)

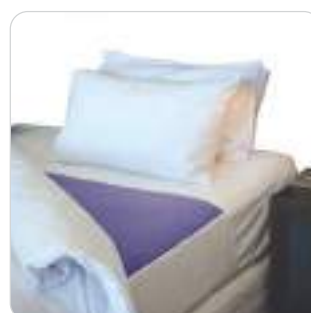

Max Bedpad  
CON245707  
(Refer to Page 122)

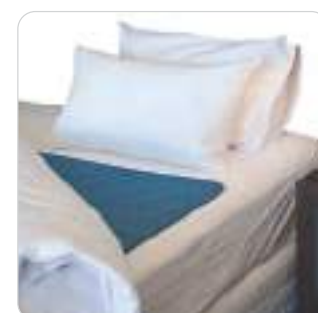

Mate Bedpad  
CON245705  
(Refer to Page 122)

#### DVA Contact Details

P 1300 888 052 | F 1300 787 052 | E [dva@aidacare.com.au](mailto:dva@aidacare.com.au)



For NDIS Item Code,  
refer to page: 508





### Lifecomfort Pressure Safety Underlay

- Provides "bottoming out" protection for air alternating mattress replacements
- Minimal height addition to overall pressure care system
- Outer cover is antimicrobial, anti bacterial, water resistant and fire retardant
- Four way rotation ensures longevity of foam performance
- Vapour permeable (breathable)
- Welded seams with water resistance zippers and reinforced waterfall flaps provide optimum confection control
- Complimentary product to be used with alternating pressure systems



Foam

Cover

Code	Description	Height	Width	Length	DVA:
BEM047050	Pressure Safety Underlay - Single	50 mm	900 mm	2000 mm	AB14
BEM047060	Pressure Safety Underlay - King Single	50 mm	1050 mm	2030 mm	AB14



### Mattress Overlay Naturelle Latex

- Anti-microbial and dust-mite resistant to alleviate allergies
- Hypoallergenic, hygienic, and antibacterial
- Optimal orthopaedic support (naturally conforming to body contours)
- Superior pressure relief that helps bring oxygen and nutrients to muscles

Code	Description	Height	Width	Length	S.W.L
BEM047181	M/ Overlay Naturelle Latex - Single	50 mm	905 mm	1880 mm	100 kg
BEM047182	M/ Overlay Naturelle Latex - Double	50 mm	1355 mm	1880 mm	100 kg
BEM047183	M/ Overlay Naturelle Latex - Queen	50 mm	1505 mm	2000 mm	100 kg
BEM047184	M/ Overlay Naturelle Latex - King	50 mm	1805 mm	2000 mm	100 kg



### Mattress Overlay Spenco

- Silicone coated fibre filled overlay
- Cylindrical hollow core fibres provide greater comfort and shear reduction
- Quality breathable cotton cover
- Heavy duty stitching
- Supplied with heat sealed waterproof cover

Code	Description	Width	Length	Warranty	S.W.L	DVA:
PTM636160	Mattress Overlay Spenco	910 mm	1980 mm	1 year	100 kg	AB14



### Mattress Overlay Silicone Fibre

- Fits under bed sheet to reduce friction and shear for the whole body
- Silicone coated cylindrical hollow core fibres construction
- Assists with geriatric and palliative care as silicone fibres do not absorb perspiration or urine
- Helps improve sleep by adding extra softness and support to the bed, even if lying in one position for extended periods

Code	Description	Height	Width	Length	S.W.L	DVA:
PTM636170	Mattress Overlay Silicone Fibre	100 mm	910 mm	1900 mm	100 kg	AB14



### Convuluted Overlay

- Fits under bed sheet to re-distribute pressure points for therapeutic pressure relief and comfort
- Improves air flow around the mattress helping to maintain a constant body temperature and improve sleep quality
- Egg shell shape/convoluted foam

Code	Description	Height	Width	Length	Warranty	DVA:
PTM636260	Convuluted Overlay - Single	50 mm	915 mm	1880 mm	1 year	AB14
PTM636270	Convuluted Overlay - Double	50 mm	1370 mm	1880 mm	1 year	AB14
PTM636280	Convuluted Overlay - Queen	50 mm	1520 mm	2030 mm	1 year	AB14

**L** Low Risk **M** Medium Risk **H** High Risk **V** Very High Risk

#### General Enquiries

P 1300 133 120 | E sales@aidacare.com.au | W www.aidacare.com.au





### Memory Foam Mattress

The ComfiMotion Memory Foam mattress contours to the users body, providing personalised comfort and transitional pressure relief. Integrated side-walls increase roll resistance at the bed edge and assist users, partners or carers with extra rigidity to ease bed entry and exit.

- Contoured Immersion: Specially layered memory foam provides contoured immersion for support and pressure relief.
- Superior breathability: Up to 8x more breathable than conventional memory foams.
- Anti-microbial: Environmentally safe treatment is added to the foam which reduces odours and kills 99.9% of bacteria.
- Eco-friendly GECA Foam is produced using cleaner chemicals and production technology.



Foam



Code	Description	Height	Width	Length
BEM469910	Comfimation Memory Foam - Long Single - Classic	2030 mm	920 mm	240 mm
BEM469920	Comfimation Memory Foam - King Single - Classic	2030 mm	1070 mm	240 mm
BEM469930	Comfimation Memory Foam - Long Single - Incontinence	2030 mm	920 mm	240 mm
BEM469940	Comfimation Memory Foam - King Single - Incontinence	2030 mm	1070 mm	240 mm



### Pocket Spring Mattress

The ComfiMotion Pocket Spring mattress offers zoned support springs that respond and contour to the individual body shape to improve comfort, maximising support and sleep quality.

- Transitional layered pocket springs arranged in weight activated support zones.
- Integrated side-walls create roll resistance at the bed edge and provide extra rigidity to ease bed entry and exit.
- Luxuriously soft pillowtop layer provides a plush immersive feeling complimented by the responsive pocket springs.



Foam



Code	Description	Height	Width	Length
BEM469800	Comfimation Classic Memory Foam - Long Single	2030 mm	920 mm	240 mm
BEM469810	Comfimation Classic Memory Foam - King Single	2030 mm	1070 mm	240 mm

DVA Contact Details

P 1300 888 052 | F 1300 787 052 | E dva@aidacare.com.au



For NDIS Item Code, refer to page: 508





Bedroom



## Lifecomfort Standard Foam Mattress

- Two layer foam support design for comfort and support
- Full size memory foam overlay
- Two way waterproof stretch cover
- Vinyl bottom cover
- Three sided zip for easy cover removal
- Welded zipper cover with waterproof flap for the best hygiene

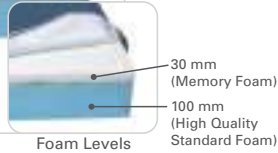

Code	Description	Height	Width	Length	S.W.L	DVA:
BEM046410	Standard Foam Mattress - AC Series Single	130 mm	900 mm	2000 mm	120 kg	AB14
BEM046425	Standard Foam Mattress - Small	130 mm	820 mm	1920 mm	120 kg	AB14
BEM046460	Standard Foam Mattress - King Single	130 mm	1050 mm	2030 mm	120 kg	AB14



## Lifecomfort Foam Mattress with Safety Sides

- Sidewall support to help minimise the risk of falls from bed
- Two layer foam support design for comfort and support
- Full size memory foam overlay
- Two way waterproof stretch cover
- Vinyl bottom cover
- Three sided zip for easy cover removal
- Welded zipper cover with waterproof flap for the best hygiene

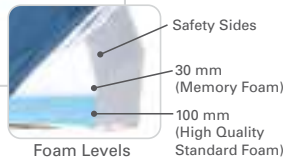

Code	Description	Height	Width	Length	Safety Sides	S.W.L	DVA:
BEM046475	Foam Mattress with Safety Sides	130 mm	900 mm	1940 mm	220 mm	120 kg	AB14

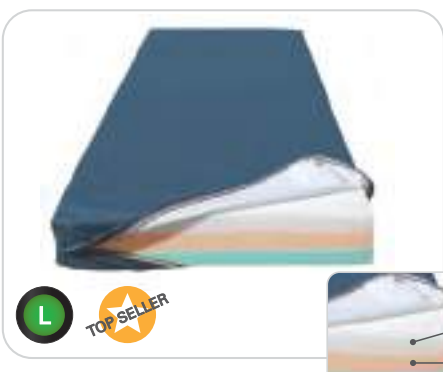

## Lifecomfort Deluxe Foam Mattress

- Three layer foam design for enhanced comfort and support
- Full size memory foam overlay
- Two way waterproof stretch cover
- Vinyl bottom cover
- Three sided zip for easy cover removal
- Welded zipper cover with waterproof flap for the best hygiene

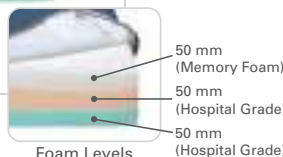

Code	Description	Height	Width	Length	S.W.L	DVA:
BEM046510	Deluxe Foam Mattress - AC Series Single	150 mm	900 mm	2000 mm	150 kg	AB14
BEM046525	Deluxe Foam Mattress - Small	150 mm	820 mm	1920 mm	150 kg	AB14
BEM046455	Deluxe Foam Mattress - King Single	150 mm	1050 mm	2030 mm	150 kg	AB14

L Low Risk
 M Medium Risk
 H High Risk
 V Very High Risk

### General Enquiries

P 1300 133 120 | E sales@aidacare.com.au | W www.aidacare.com.au



## Lifecomfort Pressure Reducing Foam Mattress

- Pressure reducing mattress
- Four layer foam support design for maximum comfort and support
- Full size memory foam overlay
- Foam side walls for extra stability on the edge of the mattress
- Two way waterproof stretch cover with welded seams
- PVC bottom cover
- Three sided zip for easy cover removal
- Welded zipper cover with waterproof flap for the best hygiene

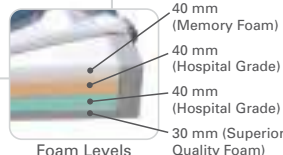

Serial Tracked

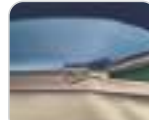

Infection Control



Foam



Cover



Code	Description	Height	Width	Length	S.W.L	DVA:
BEM046610	Pressure Reducing Foam Mattress - AC Series Single	150 mm	900 mm	2000 mm	150 kg	AB14
BEM046625	Pressure Reducing Foam Mattress - Small	150 mm	820 mm	1920 mm	150 kg	-
BEM046660	Pressure Reducing Foam Mattress - King Single	150 mm	1050 mm	2030 mm	150 kg	AB14
BEM046675	Pressure Reducing Foam Mattress - Double	150 mm	1370 mm	2030 mm	150 kg	-
BEM046680	Pressure Reducing Foam Mattress - Queen	150 mm	1520 mm	2030 mm	150 kg	-

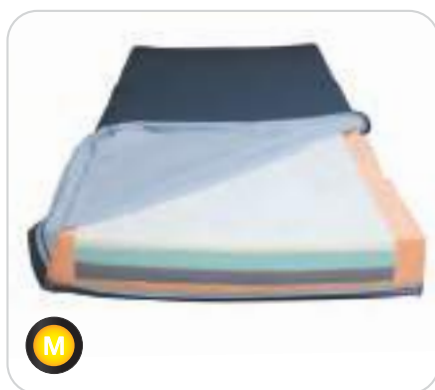

## Lifecomfort Premier Care Foam Mattress

- Pressure care mattress suitable for high risk patients
- Four layer foam support for maximum comfort and care
- Full size memory foam top layer
- Integrated cotton stockinette promotes foam longevity
- Reinforced side walls for patient stability and ease of transfers
- Inbuilt handles for safe manual handling
- Two way waterproof stretch top cover
- Heavy duty PVC base cover
- Three sided zipper for easy cover removal
- Stitched zipper cover with waterproof flap for improved infection control
- PUPPS 2 (2004) Compliant



Code	Description	Length	Width	Height	S.W.L
BEM046725	Premier Care Mattress - Single	2000 mm	900 mm	150 mm	180 kg
BEM046730	Premier Care Mattress - King Single	2000 mm	1050 mm	150 mm	180 kg



## Lifecomfort Premier Acute Care Foam Mattress

- Pressure care mattress suitable for high risk patients
- Four layer foam support for maximum comfort and support
- Full size memory foam top layer with MEMair™ Breeze open cell foam for improved microclimate
- Integrated cotton stockinette promotes foam longevity
- Reinforced side walls for patient stability and ease of transfers
- Inbuilt handles for safe manual handling
- Two way waterproof stretch top cover
- Heavy duty PVC base cover
- Three sided zipper for easy cover removal
- Stitched zipper cover with waterproof flap for improved infection control
- PUPPS 2 (2004) Compliant

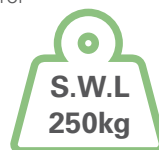

Code	Description	Length	Width	Height	S.W.L
BEM046735	Premier Care Acute Foam Mattress - Single	2000 mm	900 mm	150 mm	250 kg
BEM046740	Premier Care Acute Foam Mattress - King Single	2000 mm	1050 mm	150 mm	250 kg



### DVA Contact Details

P 1300 888 052 | F 1300 787 052 | E [dva@aidacare.com.au](mailto:dva@aidacare.com.au)



For NDIS Item Code, refer to page: 508





Bedroom



## Lifecomfort Acute Care Foam Mattress



- Acute pressure care mattress
- Castellated foam for effective pressure redistribution
- Enhanced microclimate with air channels between castellations
- Durable base facilitates patient transfers on and off the mattress
- Stitched zipper cover with waterproof flap for excellent hygiene

- High-stretch, vapour permeable, waterproof cover
- Heavy duty anthracite bottom cover for durability
- Innovative cover graphics including cleaning instructions, product specifications and 180° turning process



Serial Tracked

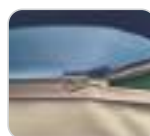

Infection Control



Foam



Cover



Code	Description	Height	Width	Length	S.W.L	DVA:
BEM046615	Acute Care Mattress - Single	150 mm	880 mm	1980 mm	250 kg	AB14
BEM046616	Acute Care Mattress - King Single	150 mm	1050 mm	2030 mm	250 kg	AB14



## Lifecomfort Bariatric Foam Mattress



- Pressure reducing bariatric mattress
- Extra weight capacity up to 300kg
- Four layer foam support 200mm high for bariatric use with maximum comfort and support
- Full size memory foam overlay
- Foam side walls for extra stability on the edge of the mattress

- Two way waterproof stretch cover with welded seams
- PVC bottom cover
- Four sided zip for easy cover removal
- Welded zipper cover with waterproof flap for the best hygiene
- Independently tested and certified for durability and weight rating

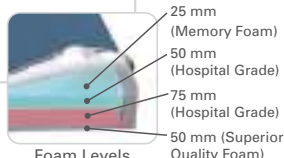

Foam Levels



Serial Tracked

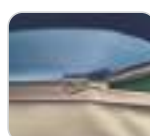

Infection Control



Foam



Cover



Code	Description	Height	Width	Length	Safety Sides	S.W.L	DVA:
BEM046700	Bariatric Foam Mattress	200 mm	1050 mm	2030 mm	300 kg	300kg	AB14



## Lifecomfort Pressure Reducing with ROHO Insert Cut Out



- Bed mattress with ultimate pressure reduction solution
- Uses standard size ROHO mattress section (PTM636320) for additional pressure relief in the pelvic section of the mattress
- Support, comfort and pressure reduction all in one
- Four layer foam support design with side walls for extra stability
- Full size memory foam overlay
- Two way welded waterproof stretch cover
- Three sided zip for easy cover removal
- Welded zipper cover with waterproof flap for the best hygiene



Cut Out



ROHO Section (Sold Separately)



Foam



Cover



Note: pictured both as the standard unit as well with the optional ROHO mattress section in place

Code	Description	Height	Width	Length	S.W.L	DVA:
BEM046720	Pressure Reducing with ROHO® Insert Cut Out	150 mm	900 mm	1940 mm	150 kg	AB14

### General Enquiries

P 1300 133 120 | E sales@aidacare.com.au | W www.aidacare.com.au



## Lifecomfort Mattress Extension Bolster

- Helps your facility deal with the variability of bed lengths reducing the risk of injury to the patient.

Code	Description	Width	Length	Height	DVA:
BEM046762	Mattress Extension Bolster - Short - 900	900 mm	100 mm	130 mm	AB14
BEM046764	Mattress Extension Bolster - Short - 1050	1050 mm	100 mm	130 mm	AB14
BEM046772	Mattress Extension Bolster - Long - 900	900 mm	200 mm	130 mm	AB14
BEM046774	Mattress Extension Bolster - Long - 1050	1050 mm	200 mm	130 mm	AB14



## ROHO® Mattress Sections

- Dry Flotation® mattress system allows user to lie or sit comfortably for long periods
- Interconnected and flexible air cells provide protection and relief for user at risk of skin breakdown or already with early stage ulcers
- Adjustable air pressure to suit the user
- Flexibility provides effective friction and shear relief
- Drainage holes allow fluids to escape

Note: Bedsize divided into 4 sections where ROHO Mattress Sections can be applied. 1, 2, 3 or 4 sections can be used in combination with foam sections where risk of pressure is not as critical

Code	Description	Height	Width	Length	S.W.L	Warranty	DVA:
PTM636335	DRY FLOATATION® Mattress Overlay (4 sections)	80 mm	860 mm	1960 mm	Unlimited	2Years	AB14
PTM636320	DRY FLOATATION® Mattress Section (1 section)	80 mm	860 mm	490 mm	Unlimited	2Years	AB14
PTM636360	Levelling Pad - Long	80 mm	864 mm	2032 mm	100 kg	2Years	AB14
PTM636220	Levelling Pad - Short	80 mm	863 mm	508 mm	100 kg	2Years	AB14



## Lifecomfort Hybrid Static & Alternating Mattress



The Lifecomfort Hybrid Mattress offers foam-in-cell technology - enabling flexible operation as either a high comfort foam static support surface or powered-up alternating pressure support surface.

- **Intelligent Hose Management** - when not in use the air-hose can be stored internally, reducing infection control and OH&S issues.
- **Optimised Heel Protection** - a 12° tapered heel zone redistributes pressure up the lower leg, away from the vulnerable heel region. The castellated surface collapses in a wave-like movement reducing shear.
- **Integrated Shear Reduction** - the memory foam overlay moves independently of the underlying cells, reducing shear as the bed profiles.
- **Memory Foam Top Layer** - integrated memory foam overlay improves immersion, envelopment and comfort.



Code	Description	Height	Width	Length	No. Of Cells	Static Head Cells	Cell Cycle	Cycle Time	S.W.L	Warranty	DVA:
PTM638010	Hybrid - Single	170 mm	895 mm	1980 mm	9	3	1 in 2	11 mins	180 kg	5 Years Foam / 2Years Cover	AB14
PTM638015	Hybrid - King Single	170 mm	1050 mm	1980 mm	9	3	1 in 2	11 mins	180 kg		AB14
PTM638030	Digital Pump	230 mm	320 mm	130 mm						2Years	AB14



### DVA Contact Details

P 1300 888 052 | F 1300 787 052 | E [dva@aidacare.com.au](mailto:dva@aidacare.com.au)

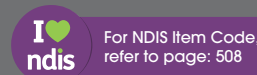

For NDIS Item Code, refer to page: 508





## Lifecomfort Hybrid Acute Static & Alternating Mattress

The Lifecomfort Hybrid Acute (230kg) Mattress Systems offer foam-in-cell technology - enabling flexible operation as either a high comfort foam static support surface or powered-up alternating pressure support surface.

- **Intelligent Hose Management** - when not in use the air-hose can be stored internally, reducing infection control and OH&S issues.
- **Optimised Heel Protection** - a 12° tapered heel zone redistributes pressure up the lower leg, away from the vulnerable heel region. The castellated surface collapses in a wave-like movement reducing shear.
- **Integrated Shear Reduction** - the memory foam overlay moves independently of the underlying cells, reducing shear as the bed profiles.
- **Memory Foam Top Layer** - integrated memory foam overlay improves immersion, envelopment and comfort.

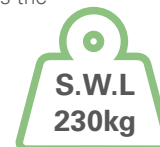

Code	Description	Height	Width	Length	No. Of Cells	Static Head Cells	Cell Cycle	Cycle Time	S.W.L	Warranty	DVA:
PTM638020	Hybrid Acute - Single	170 mm	895 mm	1980 mm	9	3	1 in 2	11 mins	230 kg	5 Years Foam / 2Years Cover	AB14
PTM638025	Hybrid Acute - King Single	170 mm	1050 mm	1980 mm	9	3	1 in 2	11 mins	230 kg		AB14
PTM638030	Digital Pump	230 mm	320 mm	130 mm						2 Years	AB14



## Lifecomfort Active Air 4 Mattress Overlay



The Active Air 4 is a lightweight, easy to use Overlay that is placed on top of an existing foam mattress. Featuring COMFORT CONTROL and offering a suite of other features, the Active Air 4 caters to users considered to be "At Risk" of Pressure Injury. An ideal solution for Home Care or Facility environments.

- Breathable multi-stretch cover
- Integrated cable management
- Simple and easy to operate semi-digital pump
- Patented cable lock protection
- Welded seams and zip protection
- 4" Overlay + Memory Foam



Code	Description	Height	Width	Length	No. Of Cells	Static Head Cells	Cell Cycle	Cycle Time	S.W.L	Warranty	DVA:
PTM639100	Active Air 4" Mattress Overlay	100 mm	850 mm	2000 mm	19	3	1 in 2	10 / 15 / 20 mins	135 kg	2yr/1yr	AB14
PTM639000	Rapid Inflation Turbo Pump										



## Lifecomfort Active Air 5 Mattress Overlay



The Active Air 5 provides an effective solution for higher weight users considered to be "At Risk" of Pressure Injury. Featuring AUTO DETECT and INTELLIGENT STATIC MODE which provide lower interface pressure and enhanced comfort, the Active Air 5 is suitable for use in a wide range of care settings from Home Care and Long Term care.

- Breathable multi-stretch cover
- Integrated cable management
- Simple and easy to operate digital pump
- Patented cable lock protection
- Welded seams and zip protection
- 5" Overlay + Foam Mattress



Code	Description	Height	Width	Length	No. Of Cells	Static Head Cells	Cell Cycle	Cycle Time	S.W.L	Warranty	DVA:
PTM639200	Active Air 5" Overlay - Single	130 mm	850 mm	2000 mm	16	3	1 in 2	10/15/20 mins	175 kg	2yr/1yr	AB14
PTM639210	Active Air 5" Overlay - King Single	130 mm	1050 mm	2000 mm	16	3	1 in 2	10/15/20 mins	175 kg	2yr/1yr	AB14
PTM639000	Rapid Inflation Turbo Pump										



### General Enquiries

P 1300 133 120 | E sales@aidacare.com.au | W www.aidacare.com.au



### Lifecomfort Active Air 8 Mattress Replacement

The Active Air 8 is a dynamic mattress replacement suitable for users at "High Risk" of Pressure Injury. Featuring AUTODETECT, and AUTOPROTECT, together with CELL-IN-CELL technology, the Active Air 8 provides the highest levels of care into Long Term care environments. The Active Air 8's innovative features ensure lowest interface pressures with an easy-to-use digital pump.

- Breathable multi-stretch cover
- Integrated cable management
- Simple and easy to operate digital pump
- Patented cable lock protection
- Welded seams and zip protection
- 8" Mattress replacement



Code	Description	Height	Width	Length	No. Of Cells	Static Head Cells	Cell Cycle	Cycle Time	S.W.L	Warranty	DVA:
PTM639300	Active Air 8" Mattress Replacement - Single	200 mm	900 mm	2000 mm	20	3	1 in 2	10/15/20/25/30 mins	200 kg	2yr/1yr	AB14
PTM639310	Active Air 8" Mattress Replacement - King Single	200 mm	1050 mm	2000 mm	20	3	1 in 2	10/15/20/25/30 mins	200 kg	2yr/1yr	AB14
PTM639000	Rapid Inflation Turbo Pump										AB14



### Lifecomfort Active Air 8 Acute Mattress Replacement

The Active Air Acute 8 is a dynamic mattress replacement suitable for users at "Very High Risk" of Pressure Injury. Featuring AUTODETECT, and AUTOPROTECT, together with CELL-IN-CELL technology, the Active Air Acute 8 provides the highest levels of care into Acute and Long Term care environments. The Active Air 8's innovative features ensure lowest interface pressures with an easy-to-use digital pump.

- Breathable multi-stretch cover
- Integrated cable management
- Simple and easy to operate digital pump
- Patented cable lock protection
- Welded seams and zip protection
- 8" Mattress replacement



Code	Description	Height	Width	Length	No. Of Cells	Static Head Cells	Cell Cycle	Cycle Time	S.W.L	Warranty	DVA:
PTM639400	Active Air Acute 8" Mattress Replacement - Single	200 mm	900 mm	2000 mm	24	3	1 in 3	10/15/20/25/30 mins	250 kg	2yr/1yr	AB14
PTM639410	Active Air Acute 8" Mattress Replacement - King Single	200 mm	1050 mm	2000 mm	24	3	1 in 3	10/15/20/25/30 mins	250 kg	2yr/1yr	AB14
PTM639000	Rapid Inflation Turbo Pump										AB14



### Lifecomfort Active Air Bari 10 Bariatric Mattress Replacement

- Quick Inflation Blower Pump** - High powered mattress pump ensures rapid inflation of mattress and constant high powered air flow for bariatric care.
- Turning Cycle** - With the ability to turn a patient, the BARI 10 ensures for safe patient transfer and lateral movement, improving manual handling and wound therapy outcomes.
- AutoDetect** - Based on the user's weight and size, appropriate pressure output is automatically set, ensuring optimal care and protection
- 1 in 2, 3 or 4 alternating air cycles provides acute level therapy for maximum pressure redistribution and wound management.
- AutoProtect** - When the head of the Bed is raised to 45° or more, air pressure automatically increases to prevent bottoming out
- Continuous Low Pressure (CLP)** - When activated, this mode increases user immersion and envelopment
- Workplace Health & Safety** - The power cord is retained within the overlay eliminating it's potential as a trip hazard
- Pressure Care Outcomes** - Intelligent cell design maximises the duration of pressure reduction in the alternation cycle



Code	Description	Height	Width	Length	No. Of Cells	Static Head Cells	Cell Cycle	Cycle Time	S.W.L	Warranty
PTM639500	Active Air BARI 10 Mattress Replacement - Single	270 mm	900 mm	2000 mm	20	3	1 in 2, 3 & 4	10 / 15 / 20 mins	450 kg	2yr/1yr
PTM639510	Active Air BARI 10 Mattress Replacement - King Single	270 mm	1070 mm	2000 mm	20	3	1 in 2, 3 & 4	10 / 15 / 20 mins	450 kg	2yr/1yr
PTM639520	Active Air BARI 10 Mattress Replacement - Super King Single	270 mm	1230 mm	2000 mm	20	3	1 in 2, 3 & 4	10 / 15 / 20 mins	450 kg	2yr/1yr

**L** Low Risk   **M** Medium Risk   **H** High Risk   **V** Very High Risk

#### DVA Contact Details

P 1300 888 052 | F 1300 787 052 | E [dva@aidacare.com.au](mailto:dva@aidacare.com.au)



For NDIS Item Code, refer to page: 508





Bedroom



**L**

## Concave Positioning Cover

- Positioning cover assists in the prevention of users rolling against side rails or falling off the bed
- A valuable accessory to any alternating mattress
- All components are heat sealed making it impermeable to fluids for maximum infection control
- Modular foam sections can be removed to enable patient transfer
- Support system also conforms to profiling beds with head raisers and knee breaks

Code	Description	Height	Width	Length	Warranty
PTM636565	Concave Positioning Cover	100 mm (outside)	880 mm	2000 mm	2Years

## Soffform Maxi Glide



**M**

- 2-surface "Glide" system reduces skin friction and shear whilst allowing the mattress to conform to changes in the bed functions
- Foam castellations on the upper surface of the mattress
- Two-way stretch PU waterproof cover
- Welded seams with full length flap conceals the zip
- Toughened PU coated base



Code	Description	Height	Width	Length	Safe Working Load	Warranty	DVA:
PTM636380	Maxi Glide	152 mm	880 mm	1970 mm	248 kg	4 years	AB14

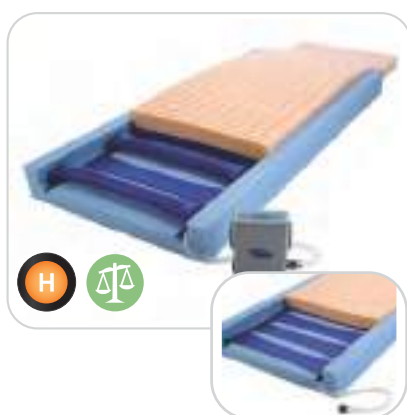

**H**

## Soffform Premier Active

- The Soffform Premier Active features an alternating air insert beneath the castellated foam insert pad
- The mattress retains its properties as a high risk static mattress, but should clinical judgement determine that the patient requires stepping up to a dynamic surface, then a discreet pump can be fitted to the air insert, transforming the mattress into an alternating surface delivering additional levels of pressure relief
- The pump will assess individual patients' weights, and adjust levels of inflation accordingly
- There is no requirement to move the patient, thereby minimising any discomfort
- The air cells alternate on a ten minute cycle beneath the foam insert, delivering a very low impact at the point of change, thereby delivering high levels of comfort in addition to improved pressure reduction
- Two-way stretch PU waterproof cover
- High frequency welded seams
- Full length flap conceals the zip
- Toughened PU coated base
- Double coated PU sides



Code	Description	Height	Width	Length	S.W.L	Warranty	DVA:
PTM636395	Premier Active	152 mm	880 mm	1970 mm	248 kg	4 years	AB14
PTM636396	Pump For Softform Premier Active				248 kg	4 years	AB14



**L** Low Risk **M** Medium Risk **H** High Risk **V** Very High Risk

### General Enquiries

P 1300 133 120 | E sales@aidacare.com.au | W www.aidacare.com.au



# Bedside Commodes



For NDIS Item Code, refer to page: 508

Brochures also available. Please contact us for a copy.

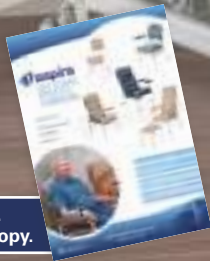

## Aspire Classic Bedside Commode



Code	Description	Overall Height	Overall Width	Overall Depth	Seat Depth	Seat Width	Backrest Height	Seat Height	Product Weight	S.W.L	DVA:
BEC045005	Classic Bedside Commode - Champagne Vinyl	900 - 1040 mm	560 mm	600 mm	440 mm	450 mm	450 mm	475 - 615 mm	5.5 kg	125 kg	BE02
BEC045006	Classic Bedside Commode - Slate Vinyl	900 - 1040 mm	560 mm	600 mm	440 mm	450 mm	450 mm	475 - 615 mm	5.5 kg	125 kg	BE02

### DVA Contact Details

P 1300 888 052 | F 1300 787 052 | E [dva@aidacare.com.au](mailto:dva@aidacare.com.au)



For NDIS Item Code, refer to page: 508





## Aspire Deluxe Bedside Commode

Raised Padded Armrests



Easy Clean Vinyl Surfaces



Removable Bowl with Lid & Carry Handle

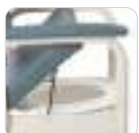

Height Adjustable

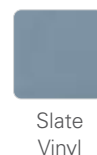
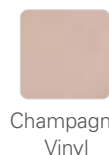

Fold Away, Padded Seat



Non-Slip Tips



Code	Description	Overall Height	Overall Width	Overall Depth	Seat Depth	Seat Width	Backrest Height	Seat Height	Product Weight	S.W.L	DVA:
BEC045115	Deluxe Bedside Commode - Champagne Vinyl	865 - 1015 mm	600 mm	600 mm	450 mm	460 mm	440 mm	410 - 565 mm	12 kg	160 kg	BE02
BEC045116	Deluxe Bedside Commode - Slate Vinyl	865 - 1015 mm	600 mm	600 mm	450 mm	460 mm	440 mm	410 - 565 mm	12 kg	160 kg	BE02



## Bedside Commode Maxi Fixed Height

- Extra seat width appropriate for maximum user weight of up to 210kg
- Fold back padded seat for easy access to commode bowl
- Comes with lift up toilet seat flap, fixed bowl carrier and bowl with removable lid and carry handle
- Fully height adjustable to suit user requirements
- Champagne colour vinyl

Code	Description	Seat Depth	Seat Width	Seat Height	Product Wt.	S.W.L	DVA:
BEC046030	Maxi Fixed Height 550	490 mm	550 mm	500 mm	15 kg	175 kg	BE02
BEC046040	Maxi Fixed Height 600	490 mm	600 mm	500 mm	15 kg	195 kg	-
BEC046050	Maxi Fixed Height 650	490 mm	650 mm	500 mm	15 kg	210 kg	-



## Aspire Commode Bowl with Handle & Lid



- Aspire Commode bowl with lid and handle for transportation
- Moulded plastic construction
- Compatible with Aspire Shower Commodes and Bedside Commodes

Code	Description	DVA:
BTC081610	Commode Bowl with Lid & Handle	BE03



# Overbed Tables

**I ♥ ndis** For NDIS Item Code, refer to page: 508

Brochures also available. Please contact us for a copy.

## Robust, Durable & Stylish Over Bed and Over Chair Tables

### Aspire Overbed Table - Laminate Flat Top



Custom colours available on request

Code	Description	Height Range	Tabletop Width	Tabletop Length	Internal Base Width	DVA:
BEA006700	Overbed Table - Beige Frame - AC White Top	730 – 1095 mm	800 mm	430 mm	670 mm	AB13
BEA006701	Overbed Table - Beige Frame - Beech Top	730 – 1095 mm	800 mm	430 mm	670 mm	AB13

#### DVA Contact Details

P 1300 888 052 | F 1300 787 052 | E [dva@aidacare.com.au](mailto:dva@aidacare.com.au)

**I ♥ ndis** For NDIS Item Code, refer to page: 508





## Aspire Overbed Table - Thermoform Recessed Top



Thermoform Table Top



Recessed Top to Prevent Spills



Quick Height Adjustment Lever



Height Fixing Knob



2 Locking Castors



Cream Thermoform

Code	Description	Height Range	Tabletop Width	Tabletop Length	Internal Base Width	DVA:
BEA028000	Overbed Table Recessed - Beige Frame - Cream Top	730 - 1095 mm	800 mm	430 mm	670 mm	AB13

## Aspire Overbed Table - Split Tilt Top



Thermoform Split Top Tilt



Wider C Base to suit Lift Recline Chairs



Recessed Top to Present Spills



Quick Height Adjustment Lever



Height Fixing Knob

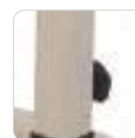

Cream Thermoform

Code	Description	Height Range	Tabletop Width	Tabletop Length	Tilt Section Width	Fixed Section Width	Internal Base Width	DVA:
BEA028100	Overbed Table Recessed Tilt - Beige Frame - Cream Top	780 - 1140 mm	800 mm	430 mm	600 mm	200 mm	800 mm	AB13



## Aspire Overbed Table - Customisable Options



*Gunmetal Grey Frame - BEA006685*



*Beige Frame - BEA006690*

### FRAME OPTIONS

Code	Description	Height Range	Internal Base Width
BEA006685	Overbed Table Frame - Gunmetal Grey	730 – 1095 mm	670 mm
BEA006690	Overbed Table Frame - Beige	730 – 1095 mm	670 mm

### AVAILABLE TABLETOP FINISHES



Sublime Teak



Milano Walnut



Recessed Cream



Beech



AC White

### TABLETOP OPTIONS

Code	Description	Tabletop Width	Tabletop Length
BEA006695	Overbed Table Top - Sublime Teak	800 mm	430 mm
BEA006696	Overbed Table Top - Milano Walnut	800 mm	430 mm
BEA006694	Overbed Table Top - Beech	800 mm	430 mm
BEA006693	Overbed Table Top - AC White	800 mm	430 mm
BEA006691	Overbed Table Top - Recessed Cream	800 mm	430 mm



### Overbed Table Dual Post

- Lightweight mobile tilting table positions over bed or chair
- Can be used for eating, drawing or other activities
- Angle adjustable to 45 degrees, ideal for homecare environment
- Fully height adjustable
- "C" base shape fitted with four castors enables close positioning to the bedside or chair

Code	Description	Height	Width	Length	DVA:
BEA015300	Overbed Table Tilt Dual Top Dual Post Heavy Duty	600 - 1000 mm	440 mm	750 mm	AB13



### Overchair Table - Four Post Tilting

- Lightweight mobile table positions over chair
- Can be used for eating, drawing or other activities
- Angle adjustable with lipped edge to prevent items slipping off
- Four height adjustable legs able to support heavier objects
- "C" base shape fitted with four castors enables close positioning to the bedside or chair
- Stylish wood grain colour finish
- Powder coated mild steel frame construction

Code	Description	Height	Width	Length
BEA015400	Overchair Table Four Post	1000 mm - 600 mm	440 mm	750 mm
BEA015500	Overchair Table Four Post - Large	1000 mm - 600 mm	600 mm	1000 mm

### DVA Contact Details

P 1300 888 052 | F 1300 787 052 | E [dva@aidacare.com.au](mailto:dva@aidacare.com.au)



For NDIS Item Code, refer to page: 508

# Bedroom Furnishings



For NDIS Item Code, refer to page: 508



## Happy Recliner Chair



The Happy Recliner Chair offers a comfortable seating surface in-room or in a mobile configuration

- Intuitive recline mechanism for patient independence
- Three comfort positions
- Adjustable padded neck pillow for postural support
- Mobility castor option for patient transportation
- Comfortable padded arms with tapered front upright for improved table access



Code	Description	Overall Height	Overall Width	Overall Depth	Seat Height	Seat Width	Seat Depth	Backrest Height
CHP198820	Happy Recliner Chair - Beige Vinyl	1080 mm	690 mm	780 mm	420 mm	520 mm	580 mm	660 mm



## Happy Sleeper Chair



The Happy Sleeper Chair facilitates the important role that family and friends play in the recovery process

- Durable seat construction preserves shape and comfort in a high use environment
- Intuitive single hand activation allows effortless conversion from chair to a comfortable sleep surface
- Recessed locking castors offer easy positioning and accessibility
- Completely flat sleep surface to maximise rest and relaxation
- Contemporary design compliments a range of care environments



Beige Vinyl



Navy Blue Vinyl



Teal Vinyl



Light Blue Vinyl



Code	Description	Overall Height	Overall Width	Overall Depth	Seat Height	Seat Width	Seat Depth	Backrest Height
CHP198810	Happy Sleeper Chair - Beige Vinyl	780 mm	760 mm	960 mm	370 mm	600 mm	580 mm	410 mm
CHP198812	Happy Sleeper Chair - Teal Vinyl	780 mm	760 mm	960 mm	370 mm	600 mm	580 mm	410 mm
CHP198814	Happy Sleeper Chair - Light Blue Vinyl	780 mm	760 mm	960 mm	370 mm	600 mm	580 mm	410 mm
CHP198816	Happy Sleeper Chair - Navy Blue Vinyl	780 mm	760 mm	960 mm	370 mm	600 mm	580 mm	410 mm

### General Enquiries

P 1300 133 120 | E sales@aidacare.com.au | W www.aidacare.com.au



### Happy Dialysis Chair

The Happy Dialysis Chair offers a comfortable seating surface in-room or in a mobile configuration for infusion therapy

- Tapered fold down armrests promote comfort and accessibility during infusion therapy
- Intuitive recline mechanism for patient independence
- Three comfort positions
- IV pole mounted to rear of chair
- Mobility castor option for patient transportation
- Lightweight and easy to move promoting workplace health and safety



Code	Description	Overall Height	Overall Width	Overall Depth	Seat Height	Seat Width	Seat Depth	Backrest Height
CHT100400	Happy Dialysis Chair - Beige Vinyl	1080 mm	690 mm	780 mm	420 mm	520 mm	580 mm	660 mm

*We offer an extensive range of finishes. Shown below is one option available.*

Cabinet 1 drawer, 1 door laminate



BEA827100

Height	Width	Depth
650 mm	455 mm	430 mm

Cabinet - 3 drawers, laminate



BEA827150

Height	Width	Depth
615 mm	600 mm	445 mm

Cabinet - 2 drawers, laminate



BEA827130

Height	Width	Depth
450 mm	450 mm	450 mm

Cabinet - 3 drawers, laminate



BEA827140

Height	Width	Depth
580 mm	500 mm	400 mm

Cabinet - 2 drawers, 1 shelf, compact



BEA827110

Height	Width	Depth
745 mm	500 mm	530 mm

Cabinet - 2 drawers, compact



BEA827120

Height	Width	Depth
755 mm	500 mm	530 mm

Cabinet - 1 drawer, 1 door, compact



BEA827090

Height	Width	Depth
735 mm	530 mm	505 mm

Cabinet - 3 drawers, 1 dump drawer



BEA828350

Height	Width	Depth
760 mm	480 mm	480 mm

Cabinet - 2 drawers, 1 door



BEA828130

Height	Width	Depth
610 mm	460 mm	450 mm

Cabinet - 1 draw, open shelf & 1 dump drawer



BEA828360

Height	Width	Depth
750 mm	460 mm	450 mm

Cabinet - 3 drawers, 1 dump drawer



BEA828370

Height	Width	Depth
685 mm	480 mm	460 mm

Cabinet - 2 drawers, 1 dump drawer

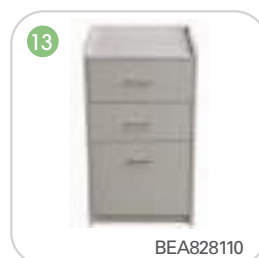

BEA828110

Height	Width	Depth
810 mm	460 mm	450 mm

Cabinet - 3 drawers



BEA828380

Height	Width	Depth
750 mm	450 mm	450 mm

Cabinet - 3 drawers



BEA828390

Height	Width	Depth
750 mm	450 mm	450 mm

Cabinet - Belmont, 2 drawers, shelf



BEA828190

Height	Width	Depth
750 mm	460 mm	450 mm

#### DVA Contact Details

P 1300 888 052 | F 1300 787 052 | E [dva@aidacare.com.au](mailto:dva@aidacare.com.au)



For NDIS Item Code, refer to page: 508





Cabinet - Regent,  
3 drawers & pull out shelf



Height	Width	Depth
750 mm	450 mm	450 mm

Wide Cabinet -  
4 drawers



Height	Width	Depth
810 mm	460 mm	450 mm

Cabinet - Duke,  
Tas Oak, 3 drawers

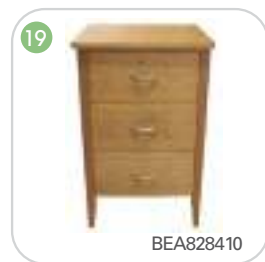

Height	Width	Depth
700 mm	500 mm	480 mm

Cabinet - 1 drawer,  
1 door



Height	Width	Depth
810 mm	460 mm	450 mm

Cabinet - 4 drawers



Height	Width	Depth
815 mm	460 mm	450 mm

Tall Cabinet - 4 drawers



Height	Width	Depth
850 mm	450 mm	450 mm

Hospital Bedside Locker



Height	Width	Depth
800 mm	460 mm	450 mm

- 16mm Moisture Resistant (MR) MDF
- Shown in 'Sublime Teak' colour
- 5x Castors 60mm Twin Wheel
- Key Lock to RHS (Keyed alike)
- Combination Lock to LHS - 3 dial, resettable

Lock to One Drawer



Code	Description
BEA828200	Lock & Keys

Hutch Cabinet -  
1 Drawer, 1 Door



Height	Width	Depth
1020 mm	460 mm	450 mm

Hutch Cabinet -  
2 Drawer, 1 Door



Height	Width	Depth
1020 mm	460 mm	450 mm

Hutch Cabinet -  
3 Drawer



Height	Width	Depth
1020 mm	460 mm	450 mm

Hutch Cabinet -  
4 Drawer



Height	Width	Depth
1020 mm	460 mm	450 mm

Wardrobe - Single Door



Height	Width	Depth
1800 mm	460 or 600 mm	570 mm

Wardrobe - Double Door



Height	Width	Depth
1800 mm	900 mm	570 mm

Wardrobe - Space Saver

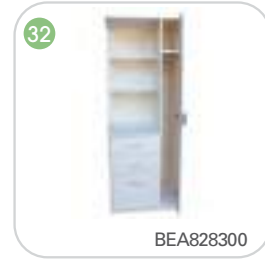

Height	Width	Depth
1800 mm	900 mm	570 mm

## Colour Options

Available, but not limited to, our Bedside Cabinets, Hutch Cabinets & Freestanding Wardrobes



- 1 Alaskan
- 2 Sublime Teak
- 3 Select Beech
- 4 Natural Walnut
- 5 Young Beech
- 6 Seasonal Oak
- 7 Belgian Oak
- 8 Natural Oak
- 9 Soft Walnut
- 10 Maison Oak

General Enquiries

P 1300 133 120 | E sales@aidacare.com.au | W www.aidacare.com.au





# Bed Sticks, Bed Poles & Other

I ♥ ndis For NDIS Item Code, refer to page: 508

Brochures also available. Please contact us for a copy.

## Aspire Bed Cradle

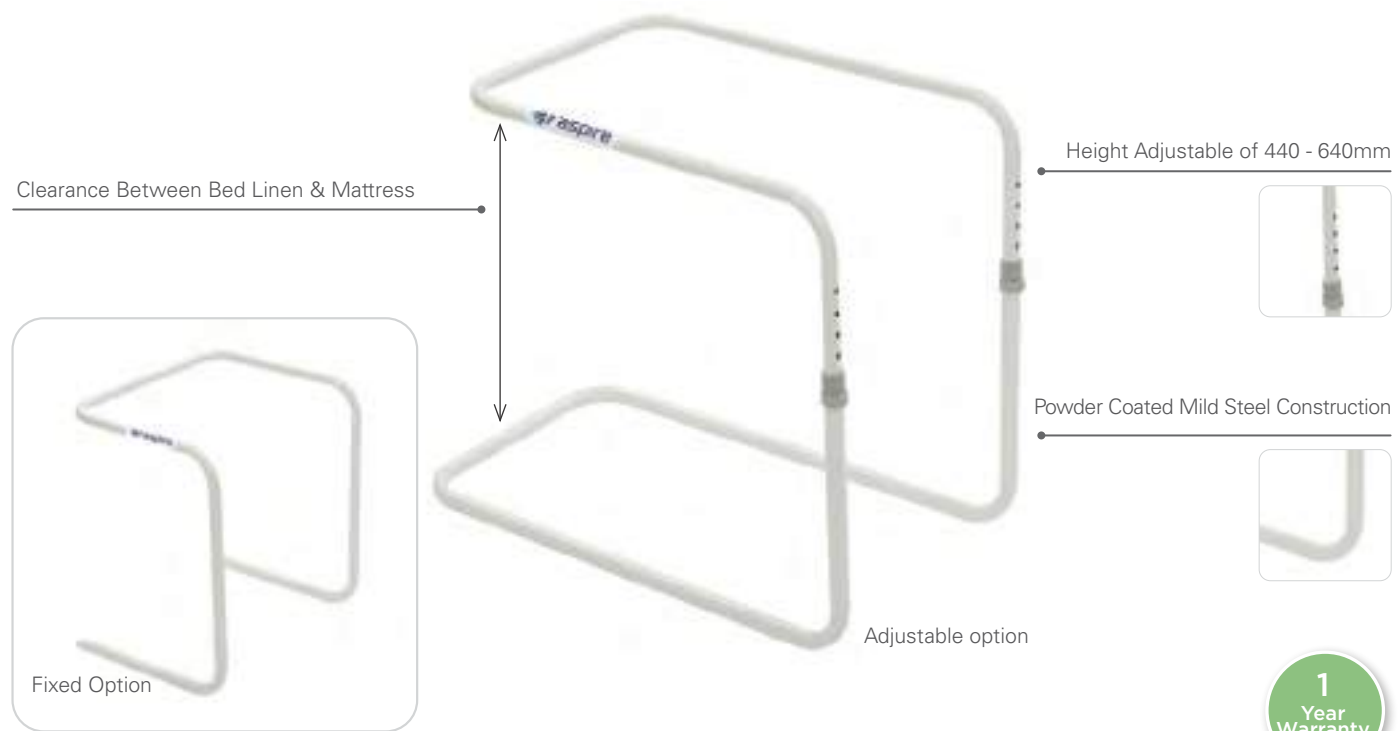

Code	Description	Overall Height	Overall Width	Overall Depth	Product Weight	DVA:
BEA014605	Bed Cradle White (Fixed)	490 mm	470 mm	320 mm	1.55 kg	AB06
BEA014610	Bed Cradle White (Adjustable)	440 mm - 640 mm	370 mm	700 mm	2.6 kg	AB06

### DVA Contact Details

P 1300 888 052 | F 1300 787 052 | E [dva@aidacare.com.au](mailto:dva@aidacare.com.au)

I ♥ ndis For NDIS Item Code, refer to page: 508





## Aspire Free Standing Self Help Pole

- Free standing support handle provides assistance for the user to reposition or transfer in and out of bed
- Handle height is easily adjusted to suit the user
- Sits behind or beside the bed
- Handle is included

Code	Description	Safe Working Load	DVA:
BEA013100	Free Standing Self Help Pole	150 kg	AB12



## Aspire Fixed Bed Rail

- Support and safety rail provides repositioning or transfer support and assists to prevent falls from bed
- Base is positioned under the mattress

Code	Description	Rail Width	Warranty	DVA:
BEA013600	Fixed Bed Rail	600 mm	1 Year	AB09



## Aspire Drop Down Bed Rail

- Support and safety rail when raised is effective at preventing falls from bed
- May be lowered down and out of the way for patient transfers or repositioning
- Base is positioned under the mattress

Code	Description	Rail Width	Warranty	DVA:
BEA013700	Drop Down Bed Rail	900 mm	1 Year	AB09



## Aspire Bed Pole with Adjustable Crook Handle

- Support pole designed to assist the user to balance while getting into and out of bed
- Adjustable crook handle can be located in multiple positions
- Base is positioned under the mattress

Code	Description	DVA:
BEA014150	Bed Pole with Adjustable Crook Handle	AB08



## Aspire Clamp on Bed Pole

- Support pole clamps on to most bed frames to provide assistance with repositioning or transferring in and out of bed
- Folding crook handle allows the pole to swing down and out of the way as required
- Clamps onto the side of most bed frames

Code	Description	DVA:
BEA009300	Clamp on Bed Pole - Right	AB08
BEA009310	Clamp on Bed Pole - Left	AB08



## Adjustable Backrest Support

- Provides support and comfort when sitting upright in bed
- Support angle is easily adjusted
- Breathable nylon back
- Powder coated mild steel frame construction

Code	Description	Warranty	DVA:
BEA014700	Bed Backrest - Adjustable Pillow Support	1 Year	AB02
BEA009900	Bed Backrest - Adjustable Deluxe	1 Year	AB02



## Bed Blocks

- Plastic block raises the height of the bed or chair
- Suitable for use after knee or hip surgery when patients have trouble standing up from bed or chair
- Stackable and sold in two sizes

Code	Description	Height	DVA:
BEA007400	Bed Blocks 40	40 mm	AB03
BEA007401	Bed Blocks 100	100 mm	AB03



## Bed/Chair Raiser

- Raisers are placed on the floor under the legs of beds or lounge chairs to raise their height
- Ideal for those recovering from hip replacements, knee operations or as a result of ageing

Code	Description	Height	DVA:
BEA009700	Bed / Chair Raiser Blocks Wooden (Pkt 4)	75 mm	AB03
BEA009500	Bed / Chair Raiser Cones (Pkt 4)	90 mm	AB03
BEA009600	Bed / Chair Raiser Cones (Pkt 4)	140 mm	AB03



## Lifecomfort Bed Rail Protectors



- Placed over the bed rail for protection and support
- Provides padding and fills gaps in bed rails, reducing injury risk to patients from either hitting bed rails or getting limbs caught
- Appropriate for static or collapsible bed rails, can still be lowered and raised
- Soft foam side rail cushions are covered with 2 way stretch PU covers
- Easy to secure velcro attachment
- Sold as a pair

Code	Description	Height	Length	DVA:
BEA010775	Bed Rail Protectors	670 mm	1260 mm	AB16
BEA010776	Bed Rail Protectors - Large	980 mm	1580 mm	AB16



## Post Operative Step

- Single and Double steps for bed access
- Single step - 240mm
- Double step - 220mm and 400mm
- Black, non-slip ribbed rubber surface
- Rubber stoppers for stability

Code	Description	Height	Warranty
BEA014900	Post Operative Step - Single	240 mm	1 Year
BEA014800	Post Operative Step - Double	220 mm & 400 mm	1 Year



## Rope Ladder Tiger Tail

- Assists users to sit upright in bed
- Strong webbing construction
- Attaches to end of the bed

Code	Description
BEA019400	Rope Ladder Tiger Tail
BEA010100	Rope Ladder

# Pillows & Supports



For NDIS Item Code, refer to page: 508



## Standard Pillow

- Silicised and polyester filled
- 650gm weight, box of 15 available

Code	Description
BEP057700	Standard Pillow



## Pillow Cover - Protect A Plas

- Protect A Plas is a waterproof soft two way stretch PVC pillow cover

Code	Description	Length	Width
BEP057400	PVC Pillow Cover	750 mm	500 mm



## Wipeclean Pillow

- Pillow easily wipes clean for effective infection control
- Bacteria & fire retardant
- Waterproof cover sewn onto the pillow

Code	Description
BEP057701	Wipeclean Pillow



## Sleepeasy Pillow

- Therapeutic postural pillow is customisable
- Long and short chambers provide for all physiques and sleeping positions
- Won't sag or lose shape

Code	Description	Height	Width	Length
BEP051500	Sleepeasy Pillow	120 mm	380 mm	560 mm



## Sleepaway Pillow

- Smaller therapeutic postural pillow that travellers can take this compact pillow similar to the one they use at home with them

Code	Description	Height	Width	Length
BEP051600	Pillow	100 mm	260 mm	390 mm
BEP051700	Pillow - Memory Foam	100 mm	260 mm	390 mm
BEP051800	Pillow - Slip Only			



## Family Pillow

- Therapeutic postural pillow
- Gently contoured for user comfort and for better posture
- Super soft eggfoam surface

Code	Description	Height	Width	Length
BEP052300	Family Pillow - Low Profile	110 mm	380 mm	550 mm
BEP052400	Family Pillow - Medium Profile	130 mm	380 mm	550 mm



## Mattress Covers

- Soft touch mattress cover is Velcro receptive, designed to fit a single bed with a simple drawstring to ensure a tight fit into the bed.

Code	Description
PTA534235	Mattress Cover



## Peanut Pillow

- Handy neck support for car, couch or beach for adults and children
- Polyester fibre fill, Poly/cotton cover

Code	Description
BEP051900	Pillow Peanut



## Bed Seat

- Sculptured cushion prevents body slip while relaxing in bed
- Encourages posture, relieves stress to lower back and is beneficial to circulation

Code	Description	Warranty	DVA:
BEP055700	Bed Seat	1Year	AE02



## Positioning Body Wedge

- Inserted into bed to assist users body positioning and posture
- Pressure diffusing memory foam supports the front or back whilst lying

Code	Description	Width	Length	DVA:
BEP055905	Positioning Body Wedge	170 mm	350 mm	AE02

### General Enquiries

P 1300 133 120 | E sales@aidacare.com.au | W www.aidacare.com.au



### Tranquillow Pillow

- Gently contoured for user comfort and to encourage better posture
- Diffuses pressure points

Code	Description	Height	Width	Length
BEP053700	Tranquillow - Soft	110 mm	400 mm	490 mm
BEP053500	Tranquillow - Small Soft	110 mm	400 mm	490 mm
BEP053600	Tranquillow - Std Deluxe	130 mm	400 mm	490 mm



### Pillow Complete Sleeprrr

- Two removable inserts for adaptable comfort and postural needs
- Gently contoured and ribbed for user comfort and to encourage better posture

Code	Description	Height	Width	Length
BEP055100	Sleeprrr	105 mm	380 mm	520 mm
BEP055300	Sleeprrr Memory Foam	105 mm	380 mm	520 mm
BEP055400	Sleeprrr Memory Foam Plus	105 mm	380 mm	520 mm



### Bed Wedge

- Inserted into bed to assist users body positioning and posture, angle at 14°
- Ideal to aid those with asthma, bronchial or breathing constraints

Code	Description	Height	Width	Length	DVA:
BEP054800	With Quilted Slip	250 mm	680 mm	750 mm	AE02
BEP054900	Contoured Plain Slip - Cover Only				AE02
BEP055000	With Waterproof Slip	250 mm	680 mm	750 mm	AE02
BEP055010	Bed Wedge Waterproof Slip Only				



### Pyramid Pillow

- Therapeutic postural pillow embraces and supports the lower lumbar spine
- Ideal for those with medical conditions requiring an elevated sleeping position

Code	Description	Height	Width	Length
BEP054100	Pillow Pyramid with Ruffled Slip	140 mm	660 mm	800 mm
BEP054200	Pillow Pyramid with Tailored Slip	140 mm	660 mm	800 mm
BEP054300	Pillow Pyramid Ruffled Slip Only			
BEP054400	Pillow Pyramid Tailored Slip Only			



### Naturelle Pillow

- Therapeutic postural pillow
- 100% pure latex construction provides wonderful comfort and support
- Gently contoured for user comfort and to encourage better posture

Code	Description	Height	Width	Length
BEP056700	Naturelle - Low	105 mm	390 mm	600 mm
BEP056800	Naturelle - Medium	120 mm	390 mm	600 mm
BEP056600	Naturelle - High	145 mm	390 mm	600 mm



### Banana Pillow

- Therapeutic postural body pillow
- Super comfy and naturally shaped to support your whole body for bedtime reading or relaxing
- Helps maintain the spine's natural curvature

Code	Description
BEP051100	Banana - Pillow (No Slip)
BEP051200	Banana Pillow - Plain Slip Only
BEP051400	Banana Pillow - Ruffled Slip Only



### Leg Spacer Memory Foam

- Rests between the knees to promote correct bed position
- Diffuses pressure, encourages circulation
- Helps align the spine and alleviate tension

Code	Description
BEP055901	Leg Spacer Memory Foam



### Travellers Pillow

- Head and neck cushion
- Perfect for travellers or for resting upright in bed or while seated
- Promotes better posture while resting

Code	Description
BEP052000	Travellers Pillow - Adult



### Quad Cushion

- Inserted behind back, knees or ankles to assist users back positioning and posture
- Provides comfort and support for the lower back, under knees or under ankles by relieving pressure

Code	Description	Height	Width	Length	DVA:
BEP056220	Quad Cushion	90 mm	260 mm	530 mm	AE02
BEP056221	Quad Cushion Replacement Slip Only				AE02



### Leg Relaxer

- Inserted into bed, assist body positioning and posture, and aids circulation in the lower limbs and provides even weight distribution
- Ideal for those with varicose veins or swollen legs, and during pregnancy

Code	Description	Height	Width	Length	DVA:
BEP056200	With Quilted Slip	200 mm	450 mm	710 mm	AB17
BEP056250	With Waterproof Slip	200 mm	450 mm	710 mm	AB17
BEP056260	Waterproof Slip Only				
BEP056300	Plain Slip Only				



### Thigh Side Sleeper

- Rests between the thighs to promote correct bed position, diffuses pressure and encourages circulation
- Helps maintain the spine's natural curvature and minimises twisting of the back during sleep, useful as a post operative aid

Code	Description	DVA:
BEP055900	Thigh Side Sleeper	AE02

#### DVA Contact Details

P 1300 888 052 | F 1300 787 052 | E [dva@aidacare.com.au](mailto:dva@aidacare.com.au)



For NDIS Item Code, refer to page: 508

# Sleep Positioning Aids



For NDIS Item Code, refer to page: 508



## W-Leg Trough

- Gives full or partial leg support. Ideal for wind, sweeping and contractures. Works with either abduction or adduction. May not require mattress cover if used as single component



## Soft T-Roll

- Excellent for leg positioning, can be easily utilised on it's own - mattress cover not required. Stops hips and knees from abducting and keeps hips in alignment during supine lying

Code	Description
PTA534233	W Leg Trough c/w Top Leg Wrap - Paediatric
PTA534234	W Leg Trough c/w Top Leg Wrap - Small
PTA534232	W Leg Trough c/w Top Leg Wrap - Medium
PTA534231	W Leg Trough c/w Top Leg Wrap - Large

Code	Description
PTA534226	T Roll
PTA534227	T Roll - Paediatric



## Long Roll / Body Roll

- Encourages and supports side lying
- Can be used in conjunction with brackets behind the client to prevent rolling



## Rigid Tri-Fold Brackets & Pads

- Can be used with or without pads to give additional support to other Snooooooze components

Code	Description
PTA534209	Long Roll - 900mm x 140mm
PTA534210	Long Roll - Paediatric
PTA534211	Multi-Roll
PTA534202	Body Roll - 2000mm x 150mm
PTA534203	Body Roll - Paediatric

Code	Description
PTA534224	Tri-Fold Bracket & Pad - Paediatric - 120 mm x 100 mm
PTA534225	Tri-Fold Bracket & Pad - Small - 150 mm x 130 mm
PTA534223	Tri-Fold Bracket & Pad - Large - 200 mm x 200 mm

### General Enquiries

P 1300 133 120 | E sales@aidacare.com.au | W www.aidacare.com.au



### Wedges

- Can be used with or without pillows to either directly support body or to give extra support to other Snooooooze elements

Code	Description
PTA534230	Wedge - Paediatric
PTA534229	Wedge - Small
PTA534228	Wedge - Large



### Star Pillow

- Offset the ability to achieve degrees of head control by changing the profiles of the points

Code	Description
PTA534218	Star Pillow - Paediatric
PTA534217	Star Pillow - Adult



### Horseshoe Pillow

- Offers the ability to achieve degrees of head control by changing the profiles of the points

Code	Description
PTA534208	Horseshoe Pillow - Medium



### Sidney Side Lyer

- Width adjustable Side Lyer holds child safely in cots, beds and even on the floor
- Easy to transport and take anywhere

Code	Description
PTA534216	Sidney Side Lyer



### Therapy Mat

- Soft touch mattress cover is Velcro receptive, designed to fit a single bed with a simple drawstring to ensure a tight fit into the bed

Code	Description
PTA534236	Therapy Mat

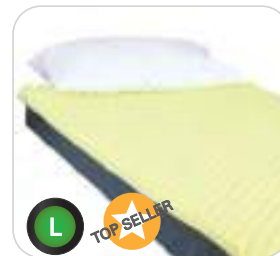

### Convoluted Overlay

- Fits under bed sheet to re-distribute pressure points for therapeutic pressure relief and comfort
- Improves air flow around the mattress helping to maintain a constant body temperature and improve sleep quality

Code	Description	DVA:
PTM636260	Convoluted Overlay - Single	AB14
PTM636270	Convoluted Overlay - Double	AB14
PTM636280	Convoluted Overlay - Queen	AB14

## More from the Foam Mattress Range



Lifecomfort Standard - AC Series  
BEM046410  
(Refer to Page 74)



Lifecomfort Deluxe - AC Series  
BEM046510  
(Refer to Page 74)



Lifecomfort Pressure Reducing  
- AC Series BEM046610  
(Refer to Page 75)



Lifecomfort Bariatric  
BEM046700  
(Refer to Page 76)

### DVA Contact Details

P 1300 888 052 | F 1300 787 052 | E [dva@aidacare.com.au](mailto:dva@aidacare.com.au)



For NDIS Item Code,  
refer to page: 508

# Falls Prevention & Alarms



For NDIS Item Code, refer to page: 508

Brochures also available. Please contact us for a copy.

## Lifecomfort Fall Safety Mat



- Designed to reduce the risk of injury, particularly the risk of head injury, when a person rolls out of bed
- The non-slip underside prevents accidental movement of the mat
- The reflective strip minimises the risk of tripping when used in low light
- When not in use, it can be easily folded for convenient and compact storage



A non-slip underside prevents unintentional movement of the mat by the carer or resident



A reflective strip helps to prevent tripping by ensuring that the mat is visible to carers and residents in low light



Divided into sections to allow for convenient folding and storage



Easily folded



Foam



Cover

Code	Description	Height	Width	Length	DVA:
BEA008550	Fall Safety Mat	50 mm	600 mm	1760 mm	AB16

### General Enquiries

P 1300 133 120 | E sales@aidacare.com.au | W www.aidacare.com.au





### Chair Alertamat

- Simple plug and play ensures carer can quickly set up the Alertamat and have it operating with ease
- Most effective when concealed under a wheelchair or chair cushion, proactively giving advanced warning of any patient at risk of falling
- Comes with alarm monitor enabling it to function as a standalone system but can also be easily connected to a centralised nurse call system
- Supplied with chair mat, alarm monitor and cables (stereo & mono)

Code	Description	Length	Width	Warranty
BEA007600	Chair Alertamat System (includes pad, monitor & cables)	380 mm	250 mm	1 Year
BEA007655	Chair Pad	BEA007630	Nurse Call Button - Stereo	
BEA007665	Alarm Monitor	BEA007635	Double Adaptor - Mono	
BEA007685	Stereo Cable	BEA007640	Double Adaptor - Stereo	
BEA007690	Mono Cable	BEA007645	Extension Cable - Mono	
BEA007625	Nurse Call Button - Mono	BEA007650	Extension Cable - Stereo	



### Bed Alertamat

- Simple plug and play ensures carer can quickly set up the Alertamat and have it operating with ease
- Most effective when concealed under a mattress, giving advanced warning of any patient at risk of falling if they attempt to leave their bed
- Comes with alarm monitor enabling it to function as a standalone system but can also be easily connected to a centralised nurse call system
- Supplied with chair mat, alarm monitor and cables (stereo & mono)

Code	Description	Length	Width	Warranty
BEA007605	Bed Alertamat System (includes pad, monitor & cables)	760 mm	250 mm	1 Year
BEA007660	Bed Pad	BEA007630	Nurse Call Button - Stereo	
BEA007665	Alarm Monitor	BEA007635	Double Adaptor - Mono	
BEA007685	Stereo Cable	BEA007640	Double Adaptor - Stereo	
BEA007690	Mono Cable	BEA007645	Extension Cable - Mono	
BEA007625	Nurse Call Button - Mono	BEA007650	Extension Cable - Stereo	



### Alerta Detect

- Infrared motion sensor system triggers an alert when body movement is detected within the range of the infrared beam
- Supplied with sensor, receiver and cables (stereo & mono)
- An alternative solution to bed pads
- Gives patients the freedom and safety of their own room whilst still proactively giving the carer advanced warning of any patient at risk of falling if they attempt to wander from their room

Code	Description	Warranty
BEA007610	Alerta Detect Infrared System (includes sensor, receiver & cables)	1 Year
BEA007670	Infrared Receiver	
BEA007675	Infrared Sensor	
BEA007680	Mains Power Cable	



### Deluxe Floor Alertamat

- A robust, long life luxury carpet mat for use on floor
- Distinguished look for the care environment and is an ideal solution for situations where a dementia resident would otherwise avoid the mat
- Simple plug and play ensures carer can quickly set up the Alertamat and have it operating with ease
- Supplied with floor mat, alarm monitor and cables (stereo & mono)

Code	Description	Length	Width	Warranty
BEA007615	Deluxe Floor Alertamat System (includes mat, monitor & cables)	900 mm	600 mm	1 Year
BEA007616	Deluxe Floor Alertamat	900 mm	600 mm	1 Year
BEA007685	Dual Stereo Cable	BEA007635	Double Adaptor - Mono	
BEA007690	Dual Mono Cable	BEA007640	Double Adaptor - Stereo	
BEA007625	Nurse Call Button - Mono	BEA007645	Extension Cable - Mono	
BEA007630	Nurse Call Button - Stereo	BEA007650	Extension Cable - Stereo	



### Floor+ Alertamat System

- Original robust, long life floor alarm system
- Most effective at the bedside or doorway to ensure carers are warned of any patient at risk of falling if they attempt to wander from their room
- Simple plug and play ensures carer can quickly set up the Alertamat and have it operating with ease
- Supplied with floor mat, alarm monitor and cables (stereo & mono)

Code	Description	Length	Width	Warranty
BEA007620	Floor+ Alertamat System (includes mat, monitor & cables)	800 mm	550 mm	1 Year
BEA007621	Floor+ Alertamat	800 mm	550 mm	1 Year
BEA007685	Dual Stereo Cable	BEA007635	Double Adaptor - Mono	
BEA007690	Dual Mono Cable	BEA007640	Double Adaptor - Stereo	
BEA007625	Nurse Call Button - Mono	BEA007645	Extension Cable - Mono	
BEA007630	Nurse Call Button - Stereo	BEA007650	Extension Cable - Stereo	



DVA: AA16

### Cura Alarms - Compatibility Matrix



CODES		BEA007428	BEA007409	BEA007456	BEA007427	BEA007410	BEA007460	BEA007466
AIDACARE		2700	2544	2721	3500	2701	2617	3501
CURA		2700	2544	2721	3500	2701	2617	3501

IMAGE	AIDACARE CODE	CURA CODE	DESCRIPTION	SUITS						
				1	2	3	4	5	6	7
<b>MONITOR</b>										
	BEA007456	2721	iBeam Wireless Motion Sensor (includes mounting bracket & batteries)	●	●		●			●
<b>MONITOR ACCESSORIES</b>										
	BEA007457	2722	EzyStand for iBeam motion sensor			●				
	BEA007430	2719	Cordless - Transmitter for Cordless Monitor 2700	●	●		●			●
	BEA007543	2642	Caregiver Reset Key (use with 2701, 2700)	●				●		
	BEA007545	3504	Wall Mounting Bracket (for 2700, 2701, 3501)	●				●		●
	BEA007546	2741	Monitor Soft Cover For Monitors with rubber strap (NEW - use with 2701, 2700)	●				●		
	BEA007548	2638	Nurse call pendant with 2mtr. Cord (use with 2544)		●					
	BEA007549	3502	ActiveCare Wireless Handset (includes wall bracket)	●	●		●			●
	BEA007550	3503	ActiveCare Magnetic Reed Switch	●	●		●			●
<b>BATHROOM</b>										
	BEA007463	2558	Wireless Waterproof Call Button	●	●		●			●
	BEA007464	2559	Wireless Waterproof Reset button				●			
<b>WEARABLES</b>										
	BEA007469	2588	Personal Emergency Transmitter With Lanyard (PET)	●	●		●			●
<b>PADS</b>										
	BEA007465	2621	SafeTime Chair Pad (1 year) (380x255mm)					●		
	BEA007422	2623	SafeTime Bed Pad (1 year) (760x510mm)					●		
	BEA007432	2629	Cordless Bed Pad (760x510mm)	●	●		●			●
	BEA007434	2630	Cordless Chair Pad (380x225mm)	●	●		●			●
	BEA007436	2624B	Cordless Floor Mat (1200x600mm) - Black	●	●		●			●
	BEA007435	2624G	Cordless Floor Mat (1200x600mm) - Grey	●	●		●			●
	BEA007433	3515	Cordless Under Mattress Bed Pad 1 Year, (800 x 290)	●	●		●			●
	BEA007412	2626	Premium Bed Pad (760x510mm)	●	●			●		
	BEA007416	2628	Premium Chair Pad (380x255mm)	●	●			●		
	BEA007418	2633B	Premium Floor Mat - Heavy Duty No Slip (1220x610mm) - Black	●	●			●		
	BEA007419	2633G	Premium Floor Mat - Heavy Duty No Slip (1220x610mm) - Grey	●	●			●		
	BEA007417	3516	Premium Under Mattress Bed Pad 1 Year, (800 x 290)	●	●			●		
<b>ACCESSORIES</b>										
	BEA007485	2643	Cable Connector - 6.35mm R/Angled Plug Mono (T&S) - 2m	●				●	●	
	BEA007521	2646	Cable Connector - 6.35 Mono (T&S) - 3m	●				●	●	
	BEA007522	2493	Cable Connector - 6.35 to 3.5 Mono (T&S) - 2m	●				●	●	
	BEA007523	2460	Cable Connector - 6.35 Stereo (T&S) - 2m	●				●	●	
	BEA007524	2461	Cable Connector - 6.35 Mono to Stereo (T&S) - 3m	●				●	●	
<b>ADAPTOR LEADS FOR CONNECTING 2 DEVICES TO A NURSE CALL SYSTEM</b>										
	BEA007525	2449	Cable Connector - Two Socket Input 6.35mm (Stereo & Stereo) to 6.35 R/Angled Plug (T/R/S) - 300mm							
	BEA007526	2492	Cable Connector - Two Socket Input 6.35mm (Stereo & Mono) to 6.35 R/Angled Plug Stereo (T/R/S) - 300mm							
	BEA007527	2495	Cable Connector - Two Socket Input (6.35 Mono & 3.5 Mono) to 3.5mm Stereo (T&S) - 300mm							
	BEA007528	2497	Cable Connector - Two Socket Input 3.5mm (Mono & Mono) to 3.5 Stereo (T&S) - 300mm							

\* A Range of Direct to Nurse Call System Plugs are Available. Please Contact Your Local Aidacare Representative.

#### General Enquiries

P 1300 133 120 | E sales@aidacare.com.au | W www.aidacare.com.au

CONTACT US ON  
1300 133 120

Project  
& Fitout  
Solutions

Project  
& Fitout  
Solutions

by aidacare

# EXPERIENCE CENTRE

Consultating • Architectural • Project Management



## Solutions for

- Bedroom Suites
- Bathrooms/Ensuites
- Commercial Kitchens
- Commercial Laundries
- Allied Health Rooms
- Consulting Rooms
- Living Spaces
- Sluice Rooms
- Office Areas



10 Minutes from Melbourne Tullamarine Airport



## Chair & Table Furnishings



## Contents

- P 101 Dining Chairs
- P 103 Lounge Chairs
- P 104 Sofas
- P 105 Dining Tables
- P 106 Coffee Tables
- P 106 Office Chairs & Tables

# Chair & Table Furnishings



**STEP 1**  
Consult

- Needs
- Styles
- Aims

**STEP 2**  
Customise

We offer an extensive range of

- Finishes
- Fabrics
- Colours

*Custom swatches are available.*

**STEP 3**  
Quantity

- Quantities
- Project Time
- Planning

*Please contact your local Aidacare Representative for further information, consultation and ordering.*

*We offer an extensive range of finishes. Shown below is one option available.*

## Dining Chairs

Eiffel Chair



Asos Chair



Georgia Chair



Galaxy Chair



Vanessa Chair



Coventry Chair



Sienna Chair



Harmony Chair





We offer an extensive range of finishes. Shown below is one option available.

Gala Chair



Geneva Chair



Florence Chair



Regina Chair



Stella Chair



Avenue Chair



Froya Chair



Juliana Chair



Molly Chair

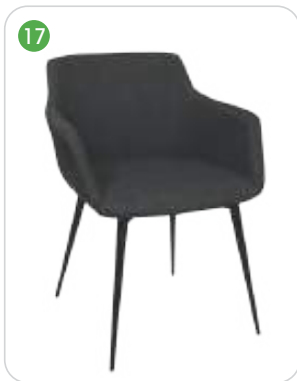

Kelly Chair



Dorset Chair



Dorset Premium Chair



Regina Bridge Chair



Maya Chair



Robin Chair



Solo Chair





We offer an extensive range of finishes. Shown below is one option available.

## Saki Woody Chair



## Vera Chair



## Sarper Chair



Chair & Table Furnishings

Code	Description	Code	Description	Code	Description	Code	Description
1	FUL030120 Eiffel Chair	8	FUL030550 Harmony Chair	15	FUL030620 Froya Chair	22	FUL030100 Maya Chair - Denim
2	FUD010100 Asos Chair	9	FUL030560 Gala Chair	16	FUL030630 Juliana Chair		FUL030100 Maya Chair - Ocean
3	FUL030500 Georgia Chair	10	FUL030570 Geneva Chair	17	FUL030640 Molly Chair	23	FUL030130 Robin Chair
4	FUL030510 Galaxy Chair	11	FUL030580 Florence Chair	18	FUL030650 Kelly Chair	24	FUL030150 Solo Chair
5	FUL030520 Vanessa Chair	12	FUL030590 Regina Chair	19	FUL030660 Dorset Chair	25	FUL030160 Saki Woody Chair
6	FUL030530 Coventry Chair	13	FUL030600 Stella Chair	20	FUL030670 Dorset Premium Chair	26	FUL030220 Vera Chair
7	FUL030540 Sienna Chair	14	FUL030610 Avenue Chair	21	FUL030680 Regina Bridge Chair	27	FUL030140 Sarper Chair

## Lounge Chairs

### Rebecca Single Sofa



### Woody Single Sofa - Black Vinyl



### Woody Single Sofa - Dark Brown Vinyl



### Hampshire Single Sofa



### Violet Armchair



### Jordan Armchair



### Leeton Armchair



### Sapphire Armchair





We offer an extensive range of finishes. Shown below is one option available.

## Cornwall Lounge Chair



## Devon Lounge Chair



1	FUL030170	Rebecca Single Sofa
2	FUL030200	Woody Single Sofa - Black Vinyl
3	FUL030200	Woody Single Sofa - Dark Brown
4	FUL030690	Hampshire Single Sofa
5	FUL030180	Violet Armchair
6	FUL030700	Jordan Armchair
7	FUL030710	Leeton Armchair
8	FUL030720	Sapphire Armchair
9	FUL030730	Cornwall Lounge Chair
10	FUL030740	Devon Lounge Chair

Chair & Table Furnishings

## Lounge Sofas

### Teo Triple Sofa



### Teo Double Sofa



### Calista Double Sofa



### Canyon Double Sofa



### Zoom Single Sofa



### Truva Double Sofa







We offer an extensive range of finishes. Shown below is one option available.

## Mirage Double Sofa



## Mirage Single Sofa



## Melbourne Lounge



## Cornwall 2 Seater Lounge



## Lawson Lounge



## Wentworth Lounge



Code	Description
1 FUL040100	Teo Triple Sofa
2 FUL040110	Teo Double Sofa
3 FUL040120	Calista Double Sofa
4 FUL040130	Canyon Double Sofa
5 FUL040140	Zoom Single Sofa
6 FUL040150	Truva Double Sofa

Code	Description
7 FUL040160	Mirage Double Sofa
8 FUL040170	Mirage Single Sofa
9 FUL040500	Melbourne Lounge
10 FUL040510	Cornwall 2 Seater Lounge
11 FUL040520	Lawson Lounge
12 FUL040530	Wentworth Lounge

## Dining Tables

### Solo Round Table



### Solo Square Table



### Vina Square Table

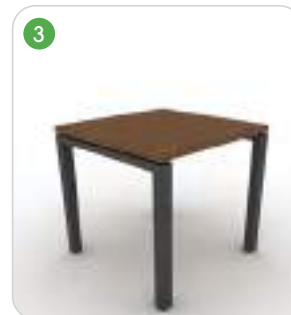

### Leo Dining Table



Code	Description
1 FUD020110	Solo Round Table
2 FUD020100	Solo Square Table
3 FUD020120	Vina Square Table
4 FUL050110	Leo Table



We offer an extensive range of finishes. Shown below is one option available.

## Coffee Tables

Poli Square Table



Poli Round Table



Poli Square Central Table



	Code	Description
1	FUL050120	Poli Square Table
2	FUL050130	Poli Round Table

	Code	Description
3	FUL050140	Poli Square Central Table

## Office Chairs

Moon Chair

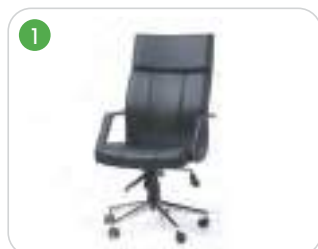

Carina Chair



Lisa Chair



Momentum Chair

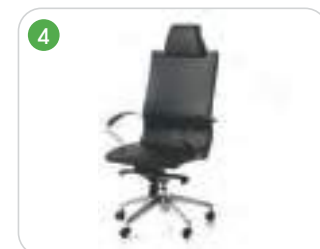

	Code	Description
1	FUO060100	Moon Manager Chair
2	FUO060110	Carina Working Chair

	Code	Description
3	FUO060120	Lisa Working Chair
4	FUO060130	Momentum Working Chair

## Office Tables & Desks

Trio Laminated Table



Alfa Workstation



Leo Meeting Table



Delfi Table w/Leather Top



Delfi Table



	Code	Description
1	FUO070100	Trio Laminated Table
2	FUO070110	Alfa Workstation
3	FUO070140	Leo Meeting Table

	Code	Description
4	FUO070120	Delfi Table w/Leather Top
5	FUO070130	Delfi Table

CONTACT US  
FOR A BROCHURE



# CARE CHAIRS

Mobile Air Chair

Shell Chair

Air Lift Chair



aspire for.....

comfort

support

protection



[www.aspirecare.com.au](http://www.aspirecare.com.au)  
1300 133 120



# Chairs - Therapeutic

# Contents

- P 109 Adjustable Height Day Chairs
- P 114 Powerlift & Recline Chairs
- P 118 Pressure Relief Chairs



# Adjustable Height Day Chairs



For NDIS Item Code, refer to page: 508



Brochures also available. Please contact us for a copy.

## Aspire High Back Classic Day Chair



Contoured Backrest for Postural Support



Softly Padded Armrests



Height Adjustable Legs - Easy Push Button



Lightweight Yet Sturdy Design



Champagne Vinyl

Slate Vinyl



Easy Clean Vinyl Surfaces



Powder Coated Steel Frame



Non-Slip Tips Provide Stability



Code	Description	Overall Height	Overall Width	Overall Depth	Seat Depth	Seat Width	Seat Height	Backrest Height	Unit Weight	S.W.L	DVA:
CHP208050	High Back Classic Day Chair - Champagne Vinyl	1155 - 1315 mm	645 mm	600 mm	490 mm	490 mm	425 - 610 mm	720 mm	16 kg	160 kg	AC01
CHP208055	High Back Classic Day Chair - Slate Vinyl	1155 - 1315 mm	645 mm	600 mm	490 mm	490 mm	425 - 610 mm	720 mm	16 kg	160 kg	AC01
CHP210300	Padded Chair Footrest - Slate Vinyl										AC07
CHP210700	Padded Chair Footrest - Champagne Vinyl										AC07
CHP208090	Transport Legs with Wheels										AC10

### General Enquiries

P 1300 133 120 | E sales@aidacare.com.au | W www.aidacare.com.au



## Aspire Waterfall Chair



Removable Cushion Sections



Padded Seat & Armrests



Height Adjustable



Waterfall Backrest Provides Comfort & Support



Powder Coated Steel Frame



Non-Slip Tips Provide Stability



Code	Description	Overall Height	Overall Width	Overall Depth	Seat Depth	Seat Width	Seat Height	Backrest Height	Unit Weight	S.W.L	DVA:
CHP208070	Waterfall Day Chair - Ink Vinyl	1045 - 1200 mm	720 mm	720 mm	490 mm	535 mm	420 - 580 mm	685 mm	16.5 kg	200 kg	AC01
CHP208071	Waterfall Day Chair - Latte Vinyl	1045 - 1200 mm	720 mm	720 mm	490 mm	535 mm	420 - 580 mm	685 mm	16.5 kg	200 kg	AC01
CHP208075	Waterfall Day Chair - Oatmeal Fabric	1045 - 1200 mm	720 mm	720 mm	490 mm	535 mm	420 - 580 mm	685 mm	16.5 kg	200 kg	AC01
CHP208076	Waterfall Day Chair - Mocha Fabric	1045 - 1200 mm	720 mm	720 mm	490 mm	535 mm	420 - 580 mm	685 mm	16.5 kg	200 kg	AC01
CHP208090	Transport Legs with Wheels										AC10

## Aspire Adjustable Day Chair



Width Adjustable (Up to 100mm)



Push Handle & Transport Wheels



Depth Adjustable up to 100mm



Height Adjustable



Code	Description	Overall Height	Overall Width	Overall Depth	Seat Depth	Seat Width	Seat Height	Backrest Height	Unit Weight	S.W.L	DVA:
CHP208025	Adjustable Day Chair - Latte Vinyl	1070 - 1220 mm	575 - 675 mm	760 - 860 mm	420 - 620 mm	510 - 610 mm	410 - 530 mm	740 - 790 mm	26 kg	160 kg	AC01
CHP208030	Adjustable Day Chair - Ink Vinyl	1070 - 1220 mm	575 - 675 mm	760 - 860 mm	420 - 620 mm	510 - 610 mm	410 - 530 mm	740 - 790 mm	26 kg	160 kg	AC01
CHP208090	Transport Legs with Wheels										AC10

### DVA Contact Details

P 1300 888 052 | F 1300 787 052 | E [dva@aidacare.com.au](mailto:dva@aidacare.com.au)



For NDIS Item Code, refer to page: 508





## Aspire Transport Legs with Wheels

- Assists carers to safely and easily tilt and manoeuvre a chair around a room (without a person in the chair)
- Compatible with High Back Day Chairs, Waterfall Day Chairs & Adjustable Day Chairs

Code	Description	DVA:
CHP208090	Transport Legs with Wheels	AC10

Code	Compatible Chairs
CHP208050	High Back Classic Day Chair – Champagne Vinyl
CHP208055	High Back Classic Day Chair – Slate Vinyl
CHP208070	High Back Waterfall Day Chair – Ink Vinyl
CHP208071	High Back Waterfall Day Chair – Latte Vinyl
CHP208075	High Back Waterfall Day Chair – Oatmeal Fabric
CHP208076	High Back Waterfall Day Chair – Mocha Fabric
CHP208025	Adjustable Day Chair - Latte Vinyl
CHP208030	Adjustable Day Chair - Ink Vinyl



## BC1 - High Back

- Stylish orthopaedic ergonomic chair
- Padded armrests and padded fully welded one piece shell
- Adjustable seat height
- Powder coated steel frame (Please specify colour at time of order)

- Large range of custom fabrics and colours available



Ink Vinyl



Latte Vinyl



Oatmeal Fabric



Denim Fabric

Code	Description	Seat Width	Backrest Height	Seat to Floor	Unit Weight	S.W.L	DVA:
CHP196500	BC1 High Back - Standard Fabrics	535 mm	630 mm	380 - 530 mm	16 kg	160 kg	AC01
CHP196501	BC1 High Back - Standard Vinyls	535 mm	630 mm	380 - 530 mm	16 kg	160 kg	AC01
CHP196502	BC1 High Back - Zircon Waterproof Colours	535 mm	630 mm	380 - 530 mm	16 kg	160 kg	-



## BC2

- High back orthopaedic ergonomic chair
- Three segment padded back cushion, padded armrests and seat for added comfort
- All cushions are removable from welded one piece shell for easy cleaning
- Powder coated steel frame (Please specify colour at time of order)

- Adjustable seat height
- Large range of custom fabrics and colours available



Ink Vinyl



Latte Vinyl



Oatmeal Fabric



Denim Fabric

Code	Description	Seat Width	Backrest Height	Seat to Floor	Unit Wt.	S.W.L	DVA:
CHP196799	BC2 - Standard Fabrics	525 mm	650 mm	430 - 580 mm	16.5 kg	160 kg	AC01
CHP196800	BC2 - Standard Vinyls	525 mm	650 mm	430 - 580 mm	16.5 kg	160 kg	AC01
CHP196802	BC2 - Zircon Waterproof Colours	525 mm	650 mm	430 - 580 mm	16.5 kg	160 kg	AC01
CHP190600	BC2 Large - Standard Colours	595 mm	780 mm	430 - 580 mm	18.5 kg	220 kg	AC01



## Todd Chair

- High back orthopaedic ergonomic comfort chair
- Built-in lumbar support, lateral support and knee bolster
- Fully adjustable seat depth and height
- Rubber stoppers for stability
- Easy to clean vinyl upholstery
- Powder coated steel frame

- Also available in pressure care model featuring pressure sensitive foams and 2-way stretch fabrics for the contact surfaces, combined with washable decorator fabrics on the outer surfaces.

- Range of colours:

**Fabric:** Tasman, Fern, Chocolate, Fawn, Rust.

**Vinyl:** Sakara, Opal, Stonewash, Blue, Stonewash Rush, Mist

(Specify fabric and colour at time of order)

Code	Description	Overall Height	Overall Width	Seat Depth	Seat to Floor	Between Arms	S.W.L	DVA:
CHP193100	Todd Chair	1070 - 1250 mm	660 mm	395 - 510 mm	410 - 585 mm	480 mm	130 kg	AC01



## Aspire Low Back Classic Day Chair



Powder Coated Steel Frame

Contoured Backrest for Postural Support



Softly Padded Armrests



Height Adjustable Legs - Easy Push Button



Lightweight Yet Sturdy Design



Easy Clean Vinyl Surfaces

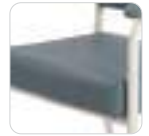

Non-slip Tips Provide Stability



Code	Description	Overall Height	Overall Width	Overall Depth	Seat Depth	Seat Width	Seat Height	Backrest Height	Unit Weight	S.W.L	DVA:
CHP208000	Low Back Classic Day Chair - Champagne Vinyl	845 - 1015 mm	580 mm	600 mm	440 mm	460 mm	430 - 605 mm	440 mm	9 kg	160 kg	AC01
CHP208005	Low Back Classic Day Chair - Slate Vinyl	845 - 1015 mm	580 mm	600 mm	440 mm	460 mm	430 - 605 mm	440 mm	9 kg	160 kg	AC01
CHP210300	Padded Chair Footrest - Slate Vinyl										AC07
CHP210700	Padded Chair Footrest - Champagne Vinyl										AC07

## Aspire Kitchen Stool



Generously Padded Seat and Back Support Surfaces



Height Adjustable Legs with Easy Push Button Adjustment and Non-Slip Rubber Tips for Stability



Seat with Anterior Tilt Facilitates Standing from Sitting and Provides Greater Comfort for Stiff or Painful Hips

Raised Armrests Assist User in Transferring On and Off Stool

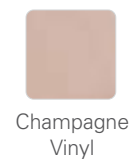
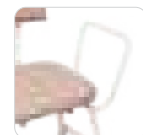

Code	Description	Overall Height	Seat Height	Overall Width	Overall Depth	Seat Depth	Seat Width	Between Arms	Unit Weight	S.W.L	Warranty	DVA:
CHP213500	Kitchen Stool	950 - 1100 mm	540 - 690 mm	545 mm	400 mm	310 mm	375 mm	495 mm	6.8 kg	175 kg	1 Year	AC03





## BC1 - Low Back

- Large range of custom fabrics and colours available - Please specify at time of order
- Stylish orthopaedic ergonomic chair
- Padded armrests and padded fully welded one piece shell
- Adjustable seat height
- Powder coated steel frame
- Unit weight of 15kg



Code	Description	S.W.L	DVA:
CHP196700	Standard Fabrics - 535mm	160 kg	AC01
CHP196701	Standard Vinyls - 535mm	160 kg	AC01
CHP196702	Zircon Waterproof Colours - 535mm	160 kg	-

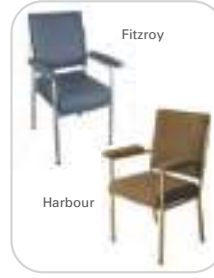

## Bridge Chairs

- Multifunction orthopaedic chair
- Low and high back versions available
- Lightweight with fully adjustable seat height
- Padded armrests, back and seat
- Rubber stoppers for stability
- Easy to clean vinyl upholstery
- Powder coated steel frame

Code	Description	S.W.L	DVA:
CHP192700	Harbour Bridge Chair - 450mm	100 kg	AC01
CHP192800	Fitzroy Bridge Chair - 450mm	130 kg	AC01

## Aspire MAXI Day Chair



Height adjustable legs with easy push button adjustment and non-slip rubber tips for stability



Height adjustable backrest and legs



Seat with anterior tilt  
- Facilitates standing from sitting and provides greater comfort for stiff or painful hips



Burgundy Vinyl



Code	Description	Overall Height	Seat Height	Overall Width	Overall Depth	Seat Depth	Between Arms	Unit Weight	S.W.L	DVA:
CHP208010	Aspire MAXI Day Chair - Burgundy Vinyl	1120 - 1440 mm	390 - 540 mm	785 - 985 mm	670 mm	500 - 670 mm	800 mm	45 kg	310 kg	AC01



## Maxi Low Back Day Chair

- Low back extra wide orthopaedic chair
- Fully adjustable seat height
- Easy to clean vinyl upholstery
- To suit the bariatric users
- Padded armrests, back and seat
- Reinforced powder coated steel frame
- Rubber stoppers for stability

Code	Description	Seat Width	Backrest Ht.	Seat to Floor	S.W.L
CHP191400	Maxi Low Back Day Chair - Champagne	550 mm	470 mm	430 - 580 mm	175 kg
CHP191500	Maxi Low Back Day Chair - Champagne	650 mm	470 mm	430 - 580 mm	210 kg
CHP191510	Maxi Low Back Day Chair - Slate	650 mm	470 mm	430 - 580 mm	210 kg



## Throne Chair

- Large sized orthopaedic ergonomic comfort chair
- Reinforced steel frame for strength
- Padded armrests and ergonomically designed padded seat
- Powder coated steel frame
- Fixed height chair for support to the bariatric user

Code	Description	S.W.L
CHP191200	Throne Chair - 700mm	400 kg



## Maxi High Back Day Chair

- Maxi high back orthopaedic bariatric chair
- Built-in lumbar support, lateral support and knee bolster
- Fully adjustable seat height, depth and angle for total comfort seating
- Rubber stoppers for stability
- Wide armrests are full length of the frame
- Powder coated steel frame

Code	Description	S.W.L
CHP191150	Maxi High Back Day Chair - 610 mm	250 kg



# Powerlift & Recline Chairs

**I ♥ ndis** For NDIS Item Code, refer to page: 508

Brochures also available. Please contact us for a copy.

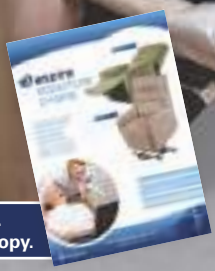

## Aspire Signature Lift Recline Chair **SPACE SAVER**



Space saving recline for close wall positioning

Depth Adjustable Seat



Choice of two depth settings in 1 inch (25mm) increments

Adjustable Cushions for Customised Comfort

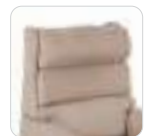

Accessible Storage



Easy Clean "Warwick" Fabric

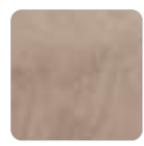

Premium Quality Electronics with USB Charger Point

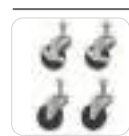

Swivel Castors

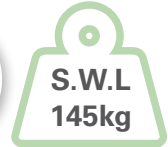

Code	Description	Overall Height	Overall Width	Overall Depth	Seat Depth	Seat Width	Seat Height	Distance From Wall	S.W.L	DVA:
CHP197700	Space Saver - Small - Mink	1010 mm	780 mm	690 mm	450 - 475 mm	450 mm	470 mm	140 mm	145 kg	AC06
CHP197705	Space Saver - Small - Lagoon	1010 mm	780 mm	690 mm	450 - 475 mm	450 mm	470 mm	140 mm	145 kg	AC06
CHP197710	Space Saver - Medium - Mink	1050 mm	780 mm	715 mm	490 - 515 mm	480 mm	480 mm	150 mm	145 kg	AC06
CHP197715	Space Saver - Medium - Lagoon	1050 mm	780 mm	715 mm	490 - 515 mm	480 mm	480 mm	150 mm	145 kg	AC06
CHP197716	Space Saver - Medium - Heritage Vinyl	1050 mm	780 mm	715 mm	490 - 515 mm	480 mm	480 mm	150 mm	145 kg	AC06
CHP197720	Space Saver - Large - Mink	1110 mm	780 mm	740 mm	510 - 535 mm	500 mm	510 mm	160 mm	145 kg	AC06
CHP197725	Space Saver - Large - Lagoon	1110 mm	780 mm	740 mm	510 mm	500 mm	510 mm	160 mm	145 kg	AC06
CHP197730	Space Saver - Large - Heritage Vinyl	1110 mm	780 mm	740 mm	510 mm	500 mm	510 mm	160 mm	145 kg	AC06

### DVA Contact Details

P 1300 888 052 | F 1300 787 052 | E [dva@aidacare.com.au](mailto:dva@aidacare.com.au)

**I ♥ ndis** For NDIS Item Code, refer to page: 508





## Aspire *Signature* Lift Recline Chair **DUAL ACTION**



Dual control of leg and recline for infinite positioning

Depth Adjustable Seat



Choice of two depth settings in 1 inch (25mm) increments

Accessible Storage



Premium Quality Electronics with USB Charger Point



Swivel Castors

Adjustable Cushions for Customised Comfort



Easy Clean "Warwick" Fabric



Warwick Global Suede - Mink



Warwick Global Suede - Lagoon

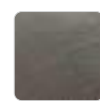

Heritage - Vinyl



Code	Description	Overall Height	Overall Width	Overall Depth	Seat Depth	Seat Width	Seat Height	Distance From Wall	S.W.L	DVA:
CHP197735	Dual Action - Small - Mink	1010 mm	780 mm	710 mm	450 - 475 mm	450 mm	470 mm	430 mm	155 kg	AC06
CHP197740	Dual Action - Small - Lagoon	1010 mm	780 mm	710 mm	450 - 475 mm	450 mm	470 mm	430 mm	155 kg	AC06
CHP197745	Dual Action - Medium - Mink	1050 mm	780 mm	735 mm	490 - 515 mm	480 mm	480 mm	455 mm	155 kg	AC06
CHP197750	Dual Action - Medium - Lagoon	1050 mm	780 mm	735 mm	490 - 515 mm	480 mm	480 mm	455 mm	155 kg	AC06
CHP197751	Dual Action - Medium - Heritage Vinyl	1050 mm	780 mm	735 mm	490 - 515 mm	480 mm	480 mm	455 mm	155 kg	AC06
CHP197755	Dual Action - Large - Mink	1110 mm	780 mm	760 mm	510 - 535 mm	500 mm	510 mm	480 mm	155 kg	AC06
CHP197760	Dual Action - Large - Lagoon	1110 mm	780 mm	760 mm	510 - 535 mm	500 mm	510 mm	480 mm	155 kg	AC06
CHP197730	Space Saver - Large - Heritage Vinyl	1110 mm	780 mm	740 mm	510 mm	500 mm	510 mm	160 mm	145 kg	AC06

## Raphael - Quattro



- Contemporary medium size
- Superior comfort and positioning
- Four motor lay-flat lift recliner
- Independent headrest and lumbar functions - Quad Action
- Colour - Bronze Microsuede
- Leather-look upholstery in microsuede
- Seat 530mm W x 510mm D
- Seat to Floor 480mm
- Backrest Height 640mm

Code	Description	S.W.L	DVA:
CHP227300	Aspire Raphael - Quattro - Bronze Microsuede	130 kg	AC06

## Altitude Vertical Lift Chair



- Contemporary medium size
- Integrated power source allows full chair functionality throughout the care environment
- Vertical lift and removable armrests facilitates safe sit-to-stand and lateral transfers
- Multi-stretch seating surface with medical vinyl outer
- Oncology Armrests (optional)
- Warranty - 1 Year - Battery & Hand Control, 2 Years - Fabric, Motors & Mechanism

Code	Description	S.W.L
CHP227700	Aspire ALTITUDE Vertical Lift Chair	150 kg
CHP227710	AltitudeVertical Lift Chair Oncology Armrest Accessory (PAIR) - Beige	150 kg

## Da Vinci - Quattro

- Contemporary medium size
- Unrivalled comfort and positioning
- Four motor lay-flat lift recliner
- Independent headrest and lumbar functions - Quad Action
- Four colour options in plush microsuede fabrics
- Seat 530mm W x 530mm D
- Seat to floor 480mm
- Handset with integrated USB port



Shown in Gunmetal



Latte Fog Dove



Code	Description	S.W.L
CHP227500	Aspire Da Vinci - Quattro - Latte	136 kg
CHP227510	Aspire Da Vinci - Quattro - Gunmetal	136 kg
CHP227520	Aspire Da Vinci - Quattro - Fog	136 kg
CHP227530	Aspire Da Vinci - Quattro - Dove	136 kg

### General Enquiries

P 1300 133 120 | E sales@aidacare.com.au | W www.aidacare.com.au



## Aspire Lift Recline Chairs

- Provides comfort and support for a wide range of body shapes and sizes
- Dual motor recliner and footrest can be operated independently
- Single control recliner and legrest work in conjunction
- Electric lift and recline for independence
- Four motor model\* for independent legrest, recliner, headrest and lumbar support
- Soft & comfortable upholstery, ideal for prolonged periods of sitting
- Large side pocket provides accessible storage
- User-friendly handset control



ZERO GRAVITY



Model	Porto	Verona	Maui	Montana
Code	CHP227200	CHP227100	CHP227110	CHP227400
Size	Petite	Medium	Medium	Large
Fabric Colours	Fawn	Angora Mushroom	Angora Mocha	Bronze Microsuede
Description	1 Motor - Space Saver	1 Motor - Space Saver	2 Motor - Dual Action	1 Motor - Heavy Duty
DVA	AC06	AC06	AC06	AC06
Seat to Floor	470 mm	480 mm	480 mm	510 mm
Seat Depth	500 mm	500 mm	500 mm	530 mm
Seat Width	490 mm	560 mm	560 mm	630 mm
Overall Length x Width	900 x 770 mm	800 x 820 mm	800 x 820 mm	880 x 940 mm
Backrest Height	750 mm	600 mm	600 mm	600 mm
Weight Capacity	150 kg	130 kg	130 kg	220 kg

## Ashley Powerlift Recline Chairs

- Provides comfort and support for a wide range of body shapes and sizes
- Quiet and smooth lift system with infinite rise and recline positions for ultimate comfort
- Available in Topsuede: Mink Brown, Lagoon Green, Denim Blue



Code	Description	Seat Depth	Seat Width	Recommended User Height	Backrest Height	S.W.L	Warranty	DVA:
CHP195900	Powerlift Recliner Ashley Petite 1 Motor	440 mm	440 mm	153 cm	580 mm	120 kg	1Year	AC06
CHP196000	Powerlift Recliner Ashley Petite 2 Motor	440 mm	440 mm	153 cm	580 mm	120 kg	1Year	-
CHP195700	Powerlift Recliner Ashley Mini 1 Motor	470 mm	480 mm	153 - 160 cm	600 mm	120 kg	1Year	AC06
CHP195800	Powerlift Recliner Ashley Mini 2 Motor	470 mm	480 mm	153 - 160 cm	600 mm	120 kg	1Year	AC06
CHP195500	Powerlift Recliner Ashley Medium 1 Motor	500 mm	480 mm	163 - 178 cm	660 mm	120 kg	1Year	AC06
CHP195600	Powerlift Recliner Ashley Medium 2 Motor	500 mm	480 mm	163 - 178 cm	660 mm	120 kg	1Year	AC06
CHP195300	Powerlift Recliner Ashley Maxi 1 Motor	550 mm	530 mm	180 - 188 cm	720 mm	120 kg	1Year	AC06
CHP195400	Powerlift Recliner Ashley Maxi 2 Motor	550 mm	530 mm	180 - 188 cm	720 mm	120 kg	1Year	AC06
CHP196100	Powerlift Recliner Ashley Tall 1 Motor	570 mm	540 mm	191 - 198 cm	740 mm	120 kg	1Year	AC06
CHP196200	Powerlift Recliner Ashley Tall 2 Motor	570 mm	540 mm	191 - 198 cm	740 mm	120 kg	1Year	-
CHP190400	Powerlift Recliner Ashley Bariatric - Large	600 mm	670 mm	180 - 188 cm	700 mm	170 kg	1Year	-
CHP190500	Powerlift Recliner Ashley Bariatric - XL	650 mm	860 mm	180 - 188 cm	720 mm	230 kg	1Year	-
CHP196250	Chair Pillow - Ashley Recliners							AC10
CHP195200	Arm & Headrest Covers for Ashley Recliner							AC10

### DVA Contact Details

P 1300 888 052 | F 1300 787 052 | E [dva@aidacare.com.au](mailto:dva@aidacare.com.au)



For NDIS Item Code, refer to page: 508





### Pride Powerlift Chairs

Pride Lift Chairs feature a 2 year warranty. Pride Lift Chairs are equipped with an emergency battery backup system should the power fail in your home.







### Specifications

**2 position:** Recline & Lift.

**3 position:** Recline, Lift, & Leg raise.

**Infinite position:** Recline, Lift, & Independent Leg raise.

**Trendelenburg:** Leg raise above the head

							
	<b>C1 Petite</b>	<b>C101</b>	<b>C5</b>	<b>C6</b>	<b>C - 101</b>	<b>LC - 101EL</b>	<b>660</b>
Size	<b>SMALL</b>	<b>MEDIUM</b>	<b>LARGE</b>	<b>MEDIUM</b>	<b>MEDIUM</b>	<b>MEDIUM</b>	<b>LARGE</b>
Standard Colour/s & Code/s	Arctic Blue - CHP197209 Chocolate - CHP197211	Pecan - CHP197050	Arctic Blue - CHP197104 Chocolate - CHP197102	Arctic Blue - CHP197204 Chocolate - CHP197202 Royal Blue Vinyl - CHP197206	Sandal - CHP197213 Cocoa - CHP197214	Choose colour (Red, Brown, Black or Beige)	Latte - CHP193702
Description	1 motor, 3-Position Lift Chair with removable upholstery	1 motor, 3-Position Lift Chair with removable upholstery	1 motor, 3-Position Chaise Lounger with removable upholstery	2 motor, Infinite-Position Chaise Lounger fully upholstered	1 motor, 3-Position Chaise Lounger	1 motor, 3-Position Chaise Lounger with European style round arm design	2 motor, Infinite-Position Chaise Lounger, fully upholstered
User Height	163 cm & below 5'4"	163 cm - 183 cm 5'4" - 6'	163 cm - 183 cm 5'4" - 6'	163 cm - 183 cm 5'4" - 6'	163 cm - 183 cm 5'4" - 6'	163 cm - 183 cm 5'4" - 6'	163 cm & below 5'4"
DVA	AC06	AC06	AC06	AC06	AC06	-	AC06
Seat to Floor	410 - 460 mm	470 mm	460 mm	480 mm	470 mm	470 mm	480 mm
Depth	510 mm	510 mm	460 - 510 mm	530 mm	510 mm	510 mm	510 mm
Width	460 mm	510 mm	560 mm	560 mm	510 mm	510 mm	510 mm
Back Width	510 mm	720 mm	710 mm	710 mm	720 mm	580 mm	710 mm
Backrest Height	660 mm	700 mm	660 - 710 mm	660 - 710 mm	700 mm	700 mm	635 mm
Safe Working Load	113 kg	147 kg	170 kg	136 kg	147 kg	147 kg	170 kg
Battery Backup	Yes	Yes	Yes	Yes	Yes	Yes	Yes

### Custom Colours:



					
	<b>560</b>	<b>LL 805</b>	<b>LC - 107</b>	<b>D30</b>	<b>LC - 358XL</b>
Size	<b>MEDIUM</b>	<b>MEDIUM</b>	<b>MEDIUM</b>	<b>LARGE</b>	<b>LARGE</b>
Standard Colour/s & Code/s	Spruce - CHP193302 Burgundy - CHP193304	Cocoa - CHP193800	Pecan - CHP197230 Burgundy - CHP197235 Ocean - CHP197240	Latte - CHP198002 Spruce - CHP198004 Royal Blue Vinyl - CHP198006	Burgundy - CHP197219 Latte - CHP197220
Description	1 motor, 3-Position Chaise Lounger, fully upholstered	1 motor, 2-Position Chaise Lounger. Wall Hugger requiring only 10cm between the wall and chair	2 motor, Infinite-Position Chaise Lounger	1 motor, 3-Position Chaise Lounger, fully upholstered	1 motor, Infinite-Position Chaise Lounger
User Height	163 cm & below 5'4"	163 cm - 183 cm 5'4" - 6'	163 cm - 183 cm 5'4" - 6'	163 cm - 183 cm 5'4" - 6'	170 cm - 186 cm 5'6" - 6'1"
DVA	AC06	-	AC06	AC06	-
Seat to Floor	480 mm	480 mm	480 mm	480 mm	510 mm
Depth	480 mm	510 mm	480 mm	560 mm	560 mm
Width	480 mm	510 mm	510 mm	560 mm	660 mm
Back Width	710 mm	775 mm	660 mm	740 mm	600 mm
Backrest Height	635 mm	685 mm	700 mm	660 mm	740 mm
Safe Working Load	170 kg	136 kg	147 kg	170 kg	227 kg
Battery Backup	Yes	Yes	Yes	Yes	Yes
Std Arm Covers	Yes	Yes	No	Yes	Yes
Std Head Covers	Yes	Yes	No	Yes	Yes

### General Enquiries

P 1300 133 120 | E sales@aidacare.com.au | W www.aidacare.com.au

# Pressure Relief Chairs

I ♥ ndis For NDIS Item Code, refer to page: 508

Brochures also available. Please contact us for a copy.



## Aspire Shell Chair



Created by Physiotherapists for Posture, Comfort & Dignity.

The lightweight and compact design allows access under tables for sharing meals, games and other activities.

### Forward/Backward Tilt Functionality

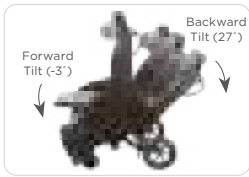

Forward tilt assists with chair egress and standing transfers. Backwards tilt functionality assists in pressure redistribution and patient stability during transfers.

### Attendant Carer Push Handle



### Removable Seat Cushion



Facilitates acute pressure care options such as utilising a ROHO cushions

### Lightweight and Manoeuvrable



12.5" rear wheels with attendant foot brake, 5" front swivel castors and a lightweight design



Pillow Headrest  
CHP198930



Footplate  
CHP198925



Retractable Lap Tray  
CHP198920



Genuine Dartex



Frame



Fabric



S.W.L  
135kg

Code	Description	Overall Width	Overall Depth	Overall Length	Seat Depth	Seat Width	Seat Height	Armrest Height	Backward Tilt	Forward Tilt	DVA:
CHP198910	Shell Chair - Medium	700 mm	890 mm	890 mm	440 mm	450 mm	450 - 530 mm	230 mm	27°	-3°	AC08
CHP198915	Shell Chair - Large	720 mm	890 mm	890 mm	470 mm	510 mm	450 - 530 mm	230 mm	27°	-3°	AC08
CHP198930	Shell Chair - Pillow Headrest										AC10
CHP198925	Shell Chair - Footplate										AC10
CHP198920	Shell Chair - Retractable Lap Tray										AC10

### DVA Contact Details

P 1300 888 052 | F 1300 787 052 | E [dva@aidacare.com.au](mailto:dva@aidacare.com.au)

I ♥ ndis For NDIS Item Code, refer to page: 508

**aidacare**  
HEALTHCARE EQUIPMENT



## Aspire Mobile Air Chair



Adjustable Foam Matrix

A matrix of air flow chambers promotes skin microclimate and evenly redistributes pressure. A higher-density outer perimeter improves midline sitting while the foam cores are movable for customised positioning

Side Transfer Compatible



Ergonomic Attendant Grip Handles



Unique design promotes skin immersion and envelopment, redistributing skin pressure, reducing the risk of pressure injury associated with prolonged sitting or lying

Patient Surface - Adjustable Pressure



Genuine Dartex



Gas Assisted Tilt 25°, Recline 90° & Leg Raise 90°

### Lie-Flat Bed Position



#### OPTIONAL ACCESSORIES

- Padded footrest CHP198860
- Rotational Tray Table CHP198862



Frame



Fabric



Code	Description	Seat Depth	Seat Width	Seat Height	Backrest Height	Overall Height	Overall Depth	Overall Width	Overall Length	Tilt Angle	Leg Raise Angle	Recline Angle	S.W.L	DVA:
CHP198850	Mobile Air Chair - Small / Short	560 mm	410 mm	650 mm	630 mm	1290 mm	690 mm	610 mm	1200 mm	0 - 25°	0 - 90°	0 - 90°	180kg	AC08
CHP198855	Mobile Air Chair - Large / Tall	560 mm	500 mm	650 mm	630 mm	1290 mm	690 mm	700 mm	1200 mm	0 - 25°	0 - 90°	0 - 90°	180kg	AC08
CHP198860	Mobile Air Chair Footrest													AC10
CHP198861	Mobile Air Chair Tray Table													AC10
CHP198862	Mobile Air Chair Rotational Tray Table													AC10

#### General Enquiries

P 1300 133 120 | E sales@aidacare.com.au | W www.aidacare.com.au



## Deluxe Bed V2

- Unique Air Comfort Seating System for total surface pressure reduction
- Tilt-in Space adjustable seat positioning with infinite locking
- Adjustable wings and arms for easy transfer
- Adjustable backrest for full recline
- Adjustable legrest with infinite raise and lower positions
- Four castors - Three braking, One directional
- Polyurethane, Anti-Microbial, Anti-Bacterial, Three-way stretch fabric
- Suits users: 142cm to 188cm
- Available in Small - Suits users up to 142cm
- Warranty: 3 Years Frame, 1 Year Fabric

Code	Description	Seat Width	Seat Depth	Seat Height	S.W.L
CHP198180	Deluxe Bed V2 - Small	430 mm	400 mm	550 mm	180 kg
CHP198190	Deluxe Bed V2 - Medium	430 mm	470 mm	550 mm	180 kg
CHP198200	Deluxe Bed V2 - Large	510 mm	550 mm	570 mm	180 kg
CHP198375	Deluxe Bed V2 - Large (Electric)	510 mm	550 mm	570 mm	180 kg
CHP198350	Maxi Deluxe Bed - Electric	720 mm	550 mm	640 mm	300 kg



## Footrests for Pressure Relief Chairs

- Easy to attach and remove
- Flips open to allow for easy transfer

Code	Description
CHP216352	Footrest - Deluxe V2 Bed - Small/Medium
CHP216351	Footrest - Deluxe V2 Bed - Large
CHP216356	Footrest - Deluxe V2 Bed - Maxi



## Tray Tables for Pressure Relief Chairs

- Handy tray accessory for pressure relief chairs

Code	Description
CHP216358	Tray - Deluxe V2 Bed - Small/Medium
CHP216353	Tray - Deluxe V2 Bed - Large
CHP217350	Tray - Deluxe V2 Bed - Maxi



## Mobile Pressure Recline Chair

- Low seat height for fall out safety and easier stand assist transfers
- Air cell cushioning combined with slow release memory foam, for excellent pressure relieving capabilities
- Adjustable and removable head rest wings
- Compact postural design with tilt in space recline action and high leg rest elevation for reduced fluid retention
- Resilient water proof stretch fabric with anti-bacterial and non-allergenic properties
- Designed for use with standing machines and transfer hoists
- Hospital quality 100mm bearing glide locking castors

Code	Description	Seat Height	Seat Depth	Seat Width	Backrest Height	S.W.L	Warranty
CHP198950	Mobile Pressure Recline Chair	500 mm	500 mm	520 mm	750 mm	130 kg	1 Year
CHP198955	Mobile Pressure Recline Chair - Footplate						
CHP198957	Mobile Pressure Recline Chair - Tray						

### DVA Contact Details

P 1300 888 052 | F 1300 787 052 | E [dva@aidacare.com.au](mailto:dva@aidacare.com.au)



For NDIS Item Code, refer to page: 508





## Aspire Air Lift Chair



Depth Adjustable by 50mm



Large Side Pocket for Convenient Storage



Leverage Grips Promote User Independence During the Sit-To-Stand Movement



Mobility Ready



Petite Model



Removable Backrest and Seat Cushion for Easy Cleaning & Maintenance



Multilayer Foam and Fibre Pillow Sections Provide a Soft, Breathable and Supportive Surface Ideal for Extended Periods Of Sitting



Padded Armrest Overlays (Petite model only)



Contoured Air Bladder in the Seating Surface Can be Easily Inflated and Adjusted with Integrated Hand Pump - Stowed and Concealed Within Chair When Not in Use



Genuine Dartex



Frame



Fabric



Code	Description	Seat Depth	Seat Width (Internal)	Backrest Height	Seat to Floor Height	DVA:
CHP198865	Air Lift Chair - Space Saver - Petite	460 mm	450 mm	610 mm	480 mm	AC06
CHP198870	Air Lift Chair - Space Saver - Large	510 mm	510 mm	610 mm	480 mm	AC06
CHP198875	Air Lift Chair - Dual Action - Petite	460 mm	450 mm	610 mm	480 mm	AC06
CHP198880	Air Lift Chair - Dual Action - Large	510 mm	510 mm	610 mm	480 mm	AC06

## Seating Matters Range



Seating Matters

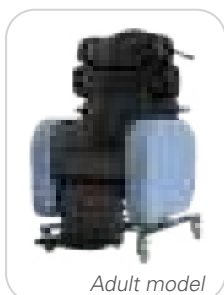

Adult model

### Phoenix Chair

- Available in multiple manual & electric combinations
  - Gives maximum support to the upper body through lateral and head supports, also adapt to the changing needs of a person being rehabilitated or meet the long term needs of a progressive condition
  - Adjustable lateral, shoulder and head supports can conform to posture and position easily
  - Tilt in space and adjustable components. Meets range of individual support needs, sizes, and levels of mobility
  - Assists in the development and maintenance of independence or for those with progressive conditions
  - Available in a paediatric version
- **Effective for adults with the following disabilities and conditions:** Cerebral palsy, Spina bifida, Spinal cord injury, Parkinson's disease, Motor neurone disease, Stroke, Multiple sclerosis, Alzheimer's disease, Advanced dementia & Osteoporosis
  - **Effective for seating clients with the following postural conditions:** Pressure ulcers, Reduced upper body tone, Kyphosis, Scoliosis, Muscle contractures & Oedema



Paediatric model

Code	Description	Overall Height	Seat Width	Seat Height	Seat Depth	SWL
CHP197800	Phoenix Chair - Paediatric	1220 mm	250 - 400 mm	540 mm	290 - 380 mm	160 kg
CHP197805	Phoenix Chair - Manual	1320 mm	400 - 500 mm	600 mm	390 - 480 mm	160 kg
CHP197810	Phoenix Chair - Electric Leg & Tilt	1320 mm	400 - 500 mm	600 mm	390 - 480 mm	160 kg
CHP197815	Phoenix Chair - Electric Leg, Recline & Tilt	1320 mm	400 - 500 mm	600 mm	390 - 480 mm	160 kg

### General Enquiries

P 1300 133 120 | E sales@aidacare.com.au | W www.aidacare.com.au



## Sorrento Chair

- Designed to improve and maximise comfort as well as postural support and pressure management, the Sorrento is simple to operate
- Adaptability and effortless adjustability
- Tilt in space, forward tilt and adjustable back angle recline can be used to improve posture and redistribute pressure
- Optional lateral supports and pillows

Code	Description	Overall Height	Seat Width	Seat Height	Seat Depth	SWL
CHP197822	Large - Manual	1320 mm	350 - 600 mm	600 mm	380 - 480 mm	160 kg
CHP197823	Bariatric - Large - Electric	1320 mm	550 - 850 mm	600 mm	410 - 660 mm	294 kg



## Atlanta Chair

- Safe and comfortable seat for those with vigorous involuntary movements while reducing the risk of falling or sliding from the chair
- Provides security without compromising function, pressure or postural management
- Used in the management of lower limb oedema. Variable angle leg rest, tilt and recline elevates the feet for optimum fluid drainage position.

Code	Description	Overall Height	Seat Width	Seat Height	Seat Depth	SWL
CHP197820	Large - Manual	1135 mm	380 - 500 mm	540 mm	480 mm	160 kg



## Monaco Chair

- For users with reduced mobility or sitting balance
- Angle adjustable seat, reduces sliding, discomfort and shear. Can also assist with stand transfers and independent ambulation.
- Adjustable back angle recline, waterfall back, optional lateral supports, and pressure management materials
- Swivel castors, push handle and sliding footplate for easy mobility and access

Code	Description	Overall Height	Seat Width	Seat Height	Seat Depth	SWL
CHP197827	Large - Manual	1205 mm	380 - 600 mm	350 - 500 mm	350 - 550 mm	160 kg



## Milano Chair

- The Milano™ tilt in space chair is designed as a simple, adjustable and affordable care chair.
- Gives support, comfort and pressure management to patients who have low to medium support needs and those who still maintain a degree of mobility
- A range of accessories are available.

Code	Description	Overall Height	Seat Width	Seat Height	Seat Depth	SWL
CHP197995	Tilt & Recline - Manual	1400 mm	400 - 500 mm	700 mm	375 - 820 mm	159 kg

## Seating Matters Chair Accessories

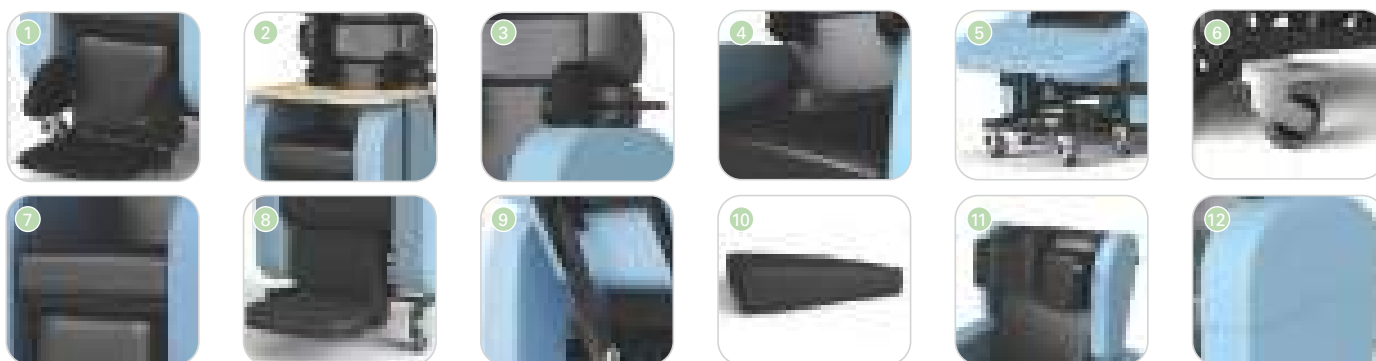

Code	Description
CHP197864	Leg Laterals - Paed Phoenix Chair
1 CHP197865	Leg Laterals - Phoenix & Sorrento Chairs
2 CHP197875	Tray Table - All Seating Matters Chairs
CHP197869	Lateral Supports - Paed Phoenix Chair
3 CHP197870	Lateral Supports - Phoenix (& Paed), Sorrento and Monaco Chairs
CHP197880	4 Point Seat Belt - All Seating Matters Chairs
CHP197885	Single Seat Belt - All Seating Matters Chairs
4 CHP197825	Variable Angle Leg Rest - Atlanta & Monaco Chairs
5 CHP197890	Twin Castors - All Seating Matters Chairs
6 CHP197895	Removable Seat Cover - All Seating Matters Chairs
7 CHP197900	Padded Footplate - All Seating Matters Chairs
8 CHP197905	Tilt Angle Display - Phoenix, Paed Phoenix & Sorrento Chairs
9 CHP197910	Seat Cushion - 350mm - Phoenix Paed Chair
10 CHP197915	Seat Cushion - 450mm - All Seating Matters Chairs

Code	Description
CHP197920	Seat Cushion - 500mm - All Seating Matters Chairs
CHP197925	Seat Cushion - Custom - All Seating Matters Chairs
11 CHP197930	Head Cushion - Concave - All Seating Matters Chairs
CHP197935	Head Cushion - Horse Shoe - All Seating Matters Chairs
CHP197940	Head Cushion - Standard - All Seating Matters Chairs
12 CHP197830	Armrest Cover - Phoenix Chair
CHP197835	Armrest Cover w/ 1in Padding - Phoenix & Sorrento Chairs
CHP197840	Armrest Cover w/ 2in Padding - Phoenix & Sorrento Chairs
CHP197845	Armrest Cover w/1in Padding - Phoenix Paed Chair
CHP197850	Armrest Cover w/2in Padding - Phoenix Paed Chair
CHP197855	Armrest Cover w/1in Padding - Atlanta Chair
CHP197860	Armrest Cover w/2in Padding - Atlanta Chair
CHP197861	Armrest Cover w/ 1in Padding - Monaco Chair
CHP197862	Armrest Cover w/ 2in Padding - Monaco Chair
CHP197863	Armrest Cover w/ 3in Padding - Monaco Chair

### DVA Contact Details

P 1300 888 052 | F 1300 787 052 | E [dva@aidacare.com.au](mailto:dva@aidacare.com.au)

**I** **ndis** For NDIS Item Code, refer to page: 508

**aidacare**  
HEALTHCARE EQUIPMENT

CONTACT US  
FOR A BROCHURE

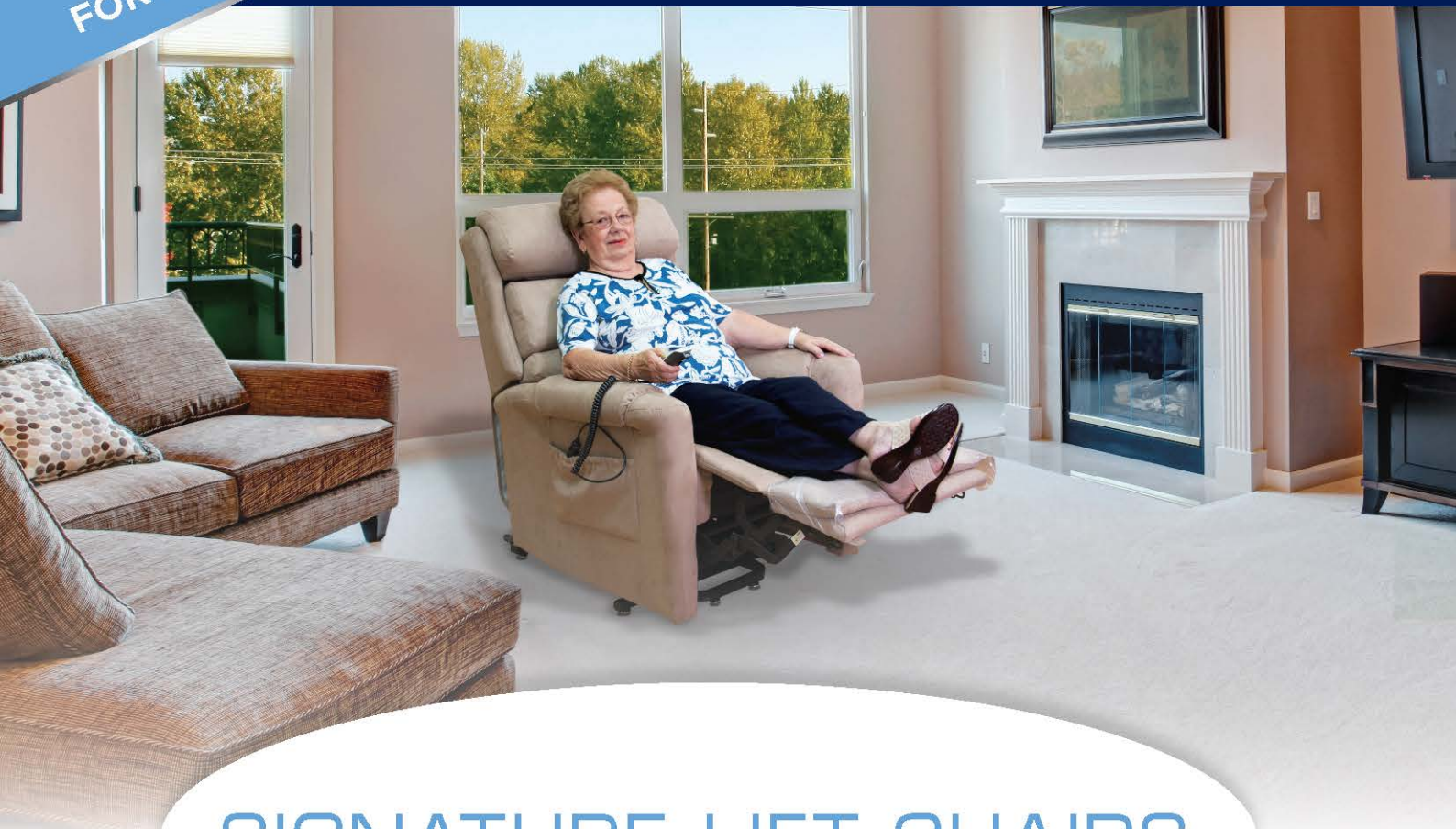

## SIGNATURE LIFT CHAIRS



Space Saver



Dual Action

aspire for.....

mobility

comfort

style



[www.aspirecare.com.au](http://www.aspirecare.com.au)  
1300 133 120



# Continence

# Contents

- P 125** Bedding & Chair Protectors
- P 127** Clothing Protectors - Disposable
- P 129** Clothing Protectors - Reusable



# Bedding & Chair Protectors

## Bed Pad Deluxe



- Super absorbent soft, non pill quilted surface
- Features large tuck in flaps designed to hold the bed pad in the correct position on the bed

Code	Description	Length	Width	Capacity
CON228600	Bed Pad Deluxe	1000 mm	1000 mm	2800 ml
CON228700	Bed Pad Super Deluxe with Waterproof Backing	800 mm	900 mm	2500 ml
CON230800	Bed Pad Extra	1000 mm	1000 mm	3500 ml

## Bed Pad Stayput, Waterproof Backing



- Designed for use at home on a single or double bed
- Waterproof non slip backing and bound edges
- Built in antibacterial barrier to retain freshness

Code	Description	Length	Width	Capacity
CON230900	Bed Pad Stayput, Waterproof Backing	700 mm	900 mm	2500 ml

## MacIntosh Waterproof Protector

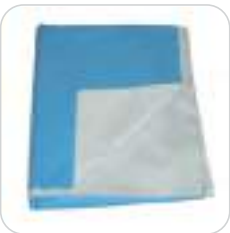

- Aimed at increasing the life span and decreasing the drying time of the bed pad
- Comes standard with tuck-ins to secure firmly on the bed
- Ideal for use with CON228600, CON230800 & CON231100

Code	Description	Width	Length
CON229100	MacIntosh Waterproof Protector	1000 mm	900 mm

## Wipeclean Pillow



- Pillow easily wipes clean for effective infection control
- Bacteria & fire retardant
- Waterproof cover sewn onto the pillow reduces the need for a separate cover
- Air easily circulates through the ends of the pillow for breathability

Code	Description
BEP057701	Wipeclean Pillow

## Mate Bedpad



- Fluid Holding Capacity 2000 mls over 8 hours
- 85 cm x 95 cm with bound edges for a longer life, suitable for all bed sizes
- Soft polyester top layer a highly absorbent core and a breathable PUL waterproof backing
- Fully washable and re-usable

Code	Description	Width	Length
CON245705	Mate Bedpad - Mauve	950 mm	850 mm
CON245706	Mate Bedpad - Teal Blue	950 mm	850 mm

## Max Bedpad



- Fluid Holding Capacity 2500 mls over 8 hrs
- 1m x 1m bed pad for single or king single beds
- Durable polyester tuck-ins each side to tuck under the mattress for extra security
- Soft polyester top layer, highly absorbent core & breathable PUL waterproof backing
- Fully washable and re-usable

Code	Description	Width	Length
CON245707	Max Bedpad - Mauve	1000 mm	1000 mm
CON245708	Max Bedpad - Teal Blue	1000 mm	1000 mm

### General Enquiries

P 1300 133 120 | E sales@aidacare.com.au | W www.aidacare.com.au



### Bed Pad Smart Barrier

- No PVC Backing - only breathable, waterproof PU (polyurethane), 2 way stretch fabric as used on premium hospital mattresses
- 100% brushed polyester facing ideal for client protection and comfort

Code	Description	Width	Length	Tuck-Ins	Colour	Capacity
CON225002	Bed Pad w/ Waterproof Backing	850 mm	900 mm	No	Light Blue	2500 ml
CON225004	Bed Pad w/ Waterproof Backing	850 mm	900 mm	Yes	Light Blue	2500 ml



### Protect A Plas

- Waterproof soft two way stretch PVC
- Can be used as a mattress cover, mattress protector, draw sheet, apron or pillow case protectors

Code	Description	Height	Width	Length
BEM047682	PVC Mattress Cover	100 mm	915 mm	1905 mm
BEM047684	PVC Mattress Cover	125 mm	915 mm	1905 mm
BEM047690	PVC Mattress Cover	150 mm	915 mm	1905 mm
BEM047700	PVC Mattress Cover	175 mm	915 mm	1905 mm
BEM047702	PVC Mattress Protector	127 mm	915 mm	1905 mm
BEM047704	PVC Mattress Protector	180 mm	915 mm	1905 mm
BEM047710	PVC Draw Sheet	-	915 mm	1520 mm
WAT765500	PVC Apron	-	850 mm	1000 mm
BEP057400	PVC Pillowcase	-	500 mm	750 mm



### Toggle Mattress Protector

- Soft, breathable and completely waterproof
- Rustle-free and will not become brittle
- Free form elastic so are easy to fit and long lasting

Code	Description	Width	Length
CON228530	Toggle Mattress Protector - Single	1880 mm	920 mm
CON228535	Toggle Mattress Protector - King Single	2030 mm	1070 mm
CON228540	Toggle Mattress Protector - Double	1880 mm	1370 mm
CON228545	Toggle Mattress Protector - Queen	2030 mm	1530 mm
CON228550	Toggle Mattress Protector - King	2030 mm	1830 mm



### Floor Mat

- Made of a heavy-duty, super absorbent top and anti-slip nitrile rubber base
- Designed to sit firm and flat on the floor to help prevent trips and allow frames and walkers to travel over safely

Code	Description	Width	Length
CON245709	Floor Mat	900 mm	600 mm



### Chair Pad Large

- Fluid holding capacity 1000 mls
- Suitable for: vehicles, wheelchairs or general furniture
- Soft polyester top layer, highly absorbent core and breathable PUL waterproof backing
- Fully washable and re-usable

Code	Description	Width	Length
CON225030	Chair Pad Large - Tartan	610 mm	510 mm
CON225035	Chair Pad Large - Teal Blue	610 mm	510 mm

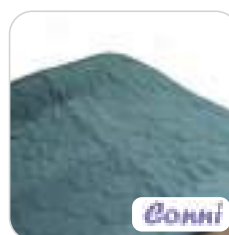

### Chair Pad Small

- Fluid Holding Capacity 1000 mls
- Suitable for: vehicles, wheelchairs or general furniture
- Soft polyester top layer, highly absorbent core and breathable PUL waterproof backing
- Fully washable and re-usable

Code	Description	Width	Length
CON225020	Chair Pad Small - Tartan	480 mm	480 mm
CON225025	Chair Pad Small - Teal Blue	480 mm	480 mm



### Chair Pad

- No PVC Backing - only breathable, waterproof PU (polyurethane), 2 way stretch fabric as used on premium hospital mattresses
- 100% brushed polyester facing ideal for client protection and comfort
- Waterproof backing
- Washable to over 150 times
- Hand, machine or industry wash and dry

Code	Description	Width	Length
CON225010	Chair Pad - Burgundy	600 mm	500 mm
CON225012	Chair Pad - Navy Blue	600 mm	500 mm
CON225014	Chair Pad - Green	600 mm	500 mm



### Chair Pad - Rectangle

- Non-slip waterproof backing designed to sit on a chair
- Large capacity of 1500mL

Code	Description	Width	Length	Capacity
CON230300	Chair Pad - Plain	500 mm	600 mm	1500 ml
CON230400	Chair Pad - Floral	500 mm	600 mm	1500 ml
CON230500	Chair Pad - Tartan	500 mm	600 mm	1500 ml

# Clothing Protectors - Disposable



## Cello Prevail Pants

- Broad soft waistband providing security and maximum comfort whilst the elasticised legs and standing leg cuffs ensure a snug fit
- Super absorbent gel to reduce odour and keep the skin dry

Code	Description	Waist	Capacity	Qty/Pack
CON244300	Cello Prevail Pants - Small	510 - 860 mm	1000 ml	22
CON244400	Cello Prevail Pants - Med	810 - 1120 mm	1000 ml	20
CON244500	Cello Prevail Pants - Large	1140 - 1480 mm	1000 ml	18



## TENA Pads Comfort

- Provides an excellent level of security, comfort and discretion
- Best suited to ambulant people or those who are able to toilet themselves
- To be used in conjunction with TENA Fix Stretch Pants or TENA Fix Cotton Special as part of a two-piece system

Code	Description	Capacity	Qty/Pack
CON243000	TENA Pads Comfort - Plus	780 ml	20
CON243100	TENA Pads Comfort - Extra	1080 ml	20
CON243200	TENA Pads Comfort - Super	1320 ml	20
CON243300	TENA Pads Comfort - Maxi	1560 ml	20



## TENA Slip

- Specially designed for those care recipients with greater needs and who could be either bed-ridden or over-active
- All-in-One product and features contoured, elasticised edges that ensure maximum security and comfort

Code	Description	Waist	Capacity	Qty/Pack
CON242000	TENA Slip Extra - Small	490 - 740 mm	1410 ml	30
CON242300	TENA Slip Maxi - Large	1000 - 1500 mm	2300 ml	8
CON242200	TENA Slip Maxi - Medium	700 - 1100 mm	2000 ml	8
CON242100	TENA Slip Maxi - Small	500 - 800 mm	1200 ml	22
CON242600	TENA Slip Plus - Large	1000 - 1500 mm	1500 ml	12
CON242500	TENA Slip Plus - Medium	700 - 1100 mm	1300 ml	12
CON242400	TENA Slip Plus - Small	500 - 800 mm	850 ml	30
CON242900	TENA Slip Super - Large	1000 - 1500 mm	1800 ml	10
CON242800	TENA Slip Super - Medium	700 - 1100 mm	1600 ml	10
CON242700	TENA Slip Super - Small	500 - 800 mm	950 ml	25



## Cello Form Pads

- Features an ultra dryness system, elasticised legs and a visual wetness indicator

Code	Description	Capacity	Qty/Pack
CON240000	Cello Form Pads - Large	2550 ml	20
CON240100	Cello Form Pads - Medium	2400 ml	20
CON240700	Cello Anaform - Petite	200 ml	20
CON240800	Cello Anaform - Midi	400 ml	20
CON241100	Cello Anaform - EcoMidi	450 ml	20
CON241200	Insert Booster - Pad 400	up to 400 ml	-



## TENA Pad Lady

- Features a special absorption technology with super-absorbent granules that quickly absorb and retain wetness
- Odour Control™ prevents odour

Code	Description	Capacity	Qty/Pack
CON243400	TENA Pad Lady - Extra	295 ml	20
CON243450	TENA Pad Lady - Extra Plus	350 ml	8
CON243500	TENA Pad Lady - Super	515 ml	30



## TENA Pads for Men

- Discreet Anatomic shape for moderate urine loss
- Adhesive strip holds the pad in place
- Odour Control™ neutralises odours
- Textile-like backing for natural comfort
- Leak-proof backing prevents staining

Code	Description	Qty/Pack
CON250000	TENA Pads for Men - Level 2 (Pack 10)	10
CON250001	TENA Pads for Men - Level 3 (Pack 8)	10
CON250002	TENA Pads for Men - Level 4 (Pack 8)	10



## TENA Active Long Liner

- Ideal for slight urine loss
- QuickDry Topsheet provides quick absorption and locks the liquid away
- Odour Control™ neutralises odours
- Cotton-like surface next to your body
- Body shape for excellent body fit

Code	Description	Qty/Pack
CON244250	TENA Active - Long	24



## TENA Super Shields

- Lightweight economical pad for those with minor faecal incontinence or very light urinary incontinence
- Body-shaped pad provides a snug fit
- Adhesive strips hold the pad securely in place

Code	Description	Qty/Pack
CON248000	TENA Super Shields	30



## TENA Pads Lady

- QuickDry Topsheet provides quick absorption and locks the liquid away
- Scented Odour Control™
- Cotton-like surface next to your body
- Body shape for excellent body fit

Code	Description	Qty/Pack
CON251000	TENA Pads Lady - Mini Ultrathin	20
CON251200	TENA Pads Lady - Mini Plus	16
CON251400	TENA Pads Lady - Normal	24



## TENA Pants Fix Cotton

- Soft cotton knit ensures a comfortable wear
- Pant gusset designed to hold pad securely as it expands
- Durable, resisting tearing and shrinkage
- Close body fit offers greater leakage security
- Longer leg enhances comfort and fit

Code	Description	Qty/Pack
CON250700	TENA Pants Fix Cotton - Small/Medium (Pkt 1)	1
CON250800	TENA Pants Fix Cotton - Large/XL (Pkt 1)	1



## TENA Pants Mesh Fix

- Male & female reusable stretch mesh pants made from textured nylon & lycra yarns
- Soft elasticised waist and leg bands
- Each size has a colour coded waist band
- Designed to hold disposable incontinence pads securely in position

Code	Description	Qty/Pack
CON250100	TENA Pants Mesh Fix - Small	25
CON250200	TENA Pants Mesh Fix - Medium	25
CON250400	TENA Pants Mesh Fix - Large	25
CON250500	TENA Pants Mesh Fix - X-Large	25
CON250600	TENA Pants Mesh Fix - XX-Large	25



## TENA Pads Flex

- FeelDry™ provides dryness, through quick inlet absorption & excellent retention
- Waist belt for easier handling for all body shapes
- Breathable backsheet™ lets the air circulate, improving user comfort and reducing skin problems

Code	Description	Qty/Pack
CON249600	TENA Pads Flex Super - Medium	30
CON249700	TENA Pads Flex Super - Large	28
CON249800	TENA Pads Flex Maxi - Medium	22
CON249900	TENA Pads Flex Maxi - Large	22
CON249960	TENA Pads Flex Maxi - Extra Large	21



## LILLE Pads Supreme Fit

- Special double pad acquisition layer-maximising absorbency
- Time/wetness indicator strip which changes colour when the pad is wet
- Contain super absorbent – maximising absorbency and odour neutralisation

Code	Description	Qty/Pack
CON259350	LILLE Pads Supreme Fit Maxi - Small	20
CON259400	LILLE Pads Supreme Fit Maxi - Medium	20
CON259500	LILLE Pads Supreme Fit Maxi - Large	20
CON259600	LILLE Pads Supreme Fit Maxi - Extra Large	20



## LILLE Classic Line

- Pads can be used in main area as a traditional incontinence product
- Super Insert is a cost effective way to boost the capacity of another pad
- Can also be used to protect a main pad from faecal smearing

Code	Description	Qty/Pack
CON259910	LILLE Classic Line Maxi	28
CON259980	LILLE Pad Super Insert	30



# Clothing Protectors - Reusable



## Clothing Protector

- Shield clothing from unwanted stains and odours
- 100% cotton facing

Code	Description	Width	Length
CON225016	Clothing Protector - Yellow Plaid	450 mm	900 mm
CON225018	Clothing Protector - Blue Tartan	450 mm	900 mm
CON229900	Clothing Protector - Plain	400 mm	840 mm
CON230000	Clothing Protector - Floral	400 mm	840 mm
CON230100	Clothing Protector - Tartan	400 mm	840 mm



## Modesty Cape

- To be used in facilities to cover the patient during transport to the shower



## Briefs Safety

- Designed to provide females with piece of mind, whilst being comfortable and discreet

Code	Description
CON236900	Modesty Cape

Code	Description	Size	Hip Measurement	Capacity
CON233600	Briefs Safety - Sml	12	900 mm	150 - 200 ml
CON233700	Briefs Safety - Med	14	950 mm	150 - 200 ml
CON233800	Briefs Safety - Lrg	16	1000 mm	150 - 200 ml
CON233900	Briefs Safety - XL	18	1050 mm	150 - 200 ml
CON234000	Briefs Safety - XXL	20	1100 mm	150 - 200 ml



## Briefs Confident

- Unisex, re-usable, absorbent and the soft stay-dry surface reduces skin irritation

Code	Description	Size	Hip Measurement	Capacity
CON232900	Briefs Confident - SmI	12	750 - 800 mm	300 - 330 ml
CON232800	Briefs Confident - Med	14	850 - 900 mm	300 - 330 ml
CON232700	Briefs Confident - Lrg	16	950 - 1000 mm	300 - 330 ml
CON233000	Briefs Confident - XL	18	1050 - 1100 mm	300 - 330 ml
CON233200	Briefs Confident - XXL	20	1150 - 1200 mm	300 - 330 ml



## Female Insert Pads

- Specifically shaped for women, supplied in a twin pack with a convenient waterproof zip bag
- Designed for light incontinence (180 mls over 4 hrs)

Code	Description	Length
CON228580	Female Insert Pads	260 mm



## Male Insert Pads

- Soft micro-fibre lining rapidly absorbs and feels dryer, flexible PUL waterproof is cool and comfortable with an elastic clip strap for secure application
- Specifically shaped for men, supplied in a twin pack with a convenient waterproof zip bag
- Designed for light incontinence (up to 250 mls over 4 hrs)

Code	Description	Length
CON228570	Male Insert Pads	380 mm



## Mens Oscar Undergarment

- Made from cotton elastane with a heavy-duty elastic waist band
- Designed for light incontinence (350 mls in a 4 hour period)
- Available in Grey only

Code	Description
CON245721	Mens Oscar Undergarment



## Male Kalven Undergarment

- Made from cotton elastane, with a front opening and heavy duty elastic waist band
- Designed for light incontinence (350 mls in a 4 hour period)
- Perfect for use after prostate surgery, the undergarment provides the support needed during the post-operative phase
- Available in Grey only

Code	Description
CON245720	Male Kalven Undergarment



## Female Classic Undergarment

- The waistline sits comfortably on the hips and the leg opening is a medium cut
- Designed for light incontinence (350 mls in a 4 hour period)
- Absorbent to the waistband both front and back for extra security, and features waterproof, breathable PUL so the user will not become hot or clammy
- Colours available in Pink, Beige and Black

Code	Description	Size
CON245716	Female Classic Undergarment	10 - 20
CON245717	Female Classic Undergarment	22, 24 & 26



## Female Chantilly Undergarment

- Constructed from cotton elastane and features pretty stretch lace in front of the leg opening
- The waistline sits comfortably just above the hips with a slightly lower cut leg
- Designed for light incontinence (350 mls in a 4 hour period)
- Colours available in Pink, Beige and Black

Code	Description	Size
CON245714	Female Chantilly Undergarment	10 - 20
CON245715	Female Chantilly Undergarment	22, 24 & 26



## Female Active Undergarment

- Designed for the active woman who needs only light protection
- This brief is fashionably styled in cotton elastane, with a semi boy leg and generous hipster fit
- The in built absorbent panty pad will hold 125 mls over a 4 hour period
- Colours available: Pink (all sizes), Beige (up to size 20) and Black (up to size 20)

Code	Description	Size
CON245718	Female Active Undergarment	10 - 20
CON245719	Female Active Undergarment	22, 24 & 26

CONTACT US  
FOR A BROCHURE



# DAY CHAIRS & COMMODES

Waterfall Day Chair



Low Back Classic Day Chair



Classic Bedside Commode



Deluxe Bedside Commode



aspire for.....

mobility

comfort

style



www.aspirecare.com.au  
1300 133 120



# Cushions & Seating

# Contents

- P 130 Cushions & Back Supports
- P 133 Pressure Care Cushions
  - P 133 - ROHO
  - P 139 - Dreamline
  - P 141 - JAY
  - P 148 - Stealth
  - P 149 - Ottobock
  - P 150 - EquaGel
  - P 150 - Promedicare
  - P 151 - Spex



# Cushions & Back Supports



For NDIS Item Code, refer to page: 508



## Multi-Purpose

- Made from extremely durable and comfortable dimple foam

Code	Description	Width	Depth	DVA:
GSS340120	Multi-Purpose	450 mm	450 mm	AE04
GSS340121	Multi-Purpose with Waterproof Cover	450 mm	450 mm	AE04



## Diffuser Cushion

- Premium density pressure-relief cushion made from memory foam
- Ideal for wheelchairs or conventional seating

Code	Description	Width	Depth	DVA:
GSS340100	Diffuser Cushion	440 mm	420 mm	AE04
GSS340103	Diffuser Cushion with Waterproof Cover	440 mm	420 mm	AE04
GSS340104	Diffuser Cushion - Large	490 mm	460 mm	AE04
GSS340105	Diffuser Cushion - Large with Waterproof Cover	490 mm	460 mm	AE04
GSS340101	Diffuser Cushion Cover - Waterproof	440 mm	420 mm	-
GSS340106	Diffuser Cushion Cover - Large - Waterproof	490 mm	460 mm	AE04

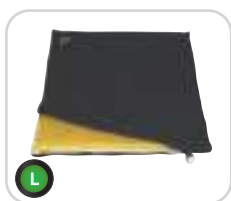

## Action Gel Pad

- A universal gel pad used to alleviate pressure build up and evenly distribute body weight
- The gel pad is covered in a waterproof film

Code	Description	Width	Depth	S.W.L	DVA:
PTC547200	Action Gel Pad	400 mm	400 mm	Unlimited	AE04
PTC547100	Action Gel Pad	450 mm	400 mm	Unlimited	AE04
PTC547000	Action Gel Pad	450 mm	450 mm	Unlimited	AE04
PTC546990	Action Gel Pad	500 mm	500 mm	Unlimited	AE04



## Posture Wedge Cushion

- Posture wedge assists with maintaining posture for persons sitting for extended periods, encourages correct pelvic tilt

Code	Description	Width	Depth	DVA:
GSS340140	Posture Wedge Cushion	420 mm	400 mm	AE01



### General Enquiries

P 1300 133 120 | E sales@aidacare.com.au | W www.aidacare.com.au



### Relief Ring Cushion

- Relief Ring Cushion shaped to help manage post-operative pain and other painful conditions.

Code	Description	DVA:
GSS340150	Relief Ring Cushion	AE04
GSS340151	Relief Ring Cover only	-



### Coccyx Tailbone Cushion

- Coccyx cushion minimises painful pressure on the coccyx region
- Ergonomically designed orthopaedic cushion

Code	Description	Width	Depth	DVA:
GSS340135	Coccyx Tailbone Cushion	420 mm	400 mm	AE04
GSS340136	Coccyx Tailbone Cushion with Waterproof Cover	420 mm	400 mm	AE04



### Keyhole Cushion

- Angled seat cushion with a symmetrical aperture
- Designed and recommended for cases of post-natal or post-operative discomfort

Code	Description	Width	Depth	DVA:
GSS340130	Keyhole Cushion	420 mm	400 mm	AE04



### Diffuser Coccyx Cushion

- Coccyx cushion for relieving pressure and pain from a bruised tailbone & coccyx

Code	Description	Width	Depth
GSS340110	Diffuser Coccyx Cushion	440 mm	420 mm
GSS340111	Diffuser Coccyx Cushion with Waterproof Cover	440 mm	420 mm



### Silicone Fibre Coccyx Cushion

- Cushion is constructed of silicone coated cylindrical hollow core fibres for extra support and comfort
- Designed for post-operative discomfort, haemorrhoids or prostate inflammation

Code	Description	Width	Depth	Height	DVA:
PTC542250	Silicone Fibre Coccyx Cushion	380 mm	420 mm	100 mm	AE04



### Spenco Chair Pad

- Soft chair pad helps to protect all pressure-prone areas of the body
- Manufactured from Silicore® fibres - unique hollow core, non matting shafts retain loft and allow air flow
- Breathable, cotton/polyester fabric is fully washable, dryable and radiotranslucent

Code	Description	Width	Depth	S.W.L	DVA:
PTC548800	Spenco Chair Pad	430 mm	430 mm	100 kg	AE04



### Silicone Fibre Cushion

- Silicone fibre filled cushion manufactured from cylindrical hollow core fibres

Code	Description	Width	Depth	S.W.L	DVA:
PTC542150	Silicone Fibre Cushion	410 mm	410 mm	100 kg	AE04
PTC542170	Silicone Fibre Cushion	410 mm	460 mm	100 kg	AE04
PTC542200	Silicone Fibre Cushion	460 mm	410 mm	100 kg	AE04



### Back Form

- Snug support for the lower back
- Supportive flanks and tapered back corners to compensate for curved bucket-type seats
- Quality removable cover

Code	Description	Width	Height	DVA:
GSS340205	Back Form	400 mm	310 mm	AE01



#### DVA Contact Details

P 1300 888 052 | F 1300 787 052 | E [dva@aidacare.com.au](mailto:dva@aidacare.com.au)



For NDIS Item Code, refer to page: 508



### Contoured Back Support

- Full length back support ensures that the entire back is supported

Code	Description	User Height	DVA:
GSS340215	Contoured Back Support - Small	1220 - 1580 mm	AE01
GSS340216	Contoured Back Support - Medium	1590 - 1860 mm	AE01
GSS340217	Contoured Back Support - Large	1870 - 2000 mm	AE01



### Flobac

- Back support featuring infinite adjustments to suit all comfort and support needs

Code	Description	Width	Length	DVA:
GSS340230	Flobac	430 mm	540 mm	AE01
GSS340231	Flobac with Beaded Seat	430 mm	540 mm	AE01



### Koala Komfort Back Support

- Has an adjustable lumbar zone to adapt to user's comfort
- Koala Komfort features a rubber bladder enclosed inside the moulded back support

Code	Description	Width	Length	DVA:
GSS340210	Koala Komfort Back Support	400 mm	280 mm	AE01



### Back Hugger

- Contoured to provide support and help alleviate lower back fatigue
- Removable insert to reduce depth or modify lumbar curve

Code	Description	Width	Length	DVA:
GSS340199	Back Hugger with Steriplus	355 mm	330 mm	AE01
GSS340200	Back Hugger with Durofab	355 mm	330 mm	AE01
GSS340201	Back Hugger with Memory Foam	355 mm	330 mm	AE01



### Total Spinal Support

- Full moulded back support has unique flanking support designed to prevent lateral movement
- Flanking support relieves stress on major structure of lumbar spine and rib cage

Code	Description	DVA:
GSS340220	Total Spinal Support - Tall (Car/Office/Chair)	AE01
GSS340221	Total Spinal Support - Medium (Couch/Home)	AE01



### Latex Multi-Use Roll

- Constructed of natural latex for maintenance of shape
- Ideal for use under ankles or between knees

Code	Description	DVA:
GSS340250	Latex Multi-Use Roll with Poly Cover	AE01
GSS340251	Waterproof Replacement Cover	-



### Lumbar Roll

- Lumbar Roll is a simple, effective product designed to discourage slouching

Code	Description	DVA:
GSS340240	Lumbar Roll - D Shape	AE01
GSS340241	Lumbar Roll - D Shape Memory Foam	AE01
GSS340248	Lumbar Roll - Demi D Shape (Small D Shape)	AE01
GSS340242	Lumbar Roll - Oval Shape	AE01
GSS340244	Lumbar Roll - Round Shape	AE01
GSS340246	Lumbar Roll - Egg Shape	AE01



### Quad Cushion

- The Quad Cushion provides comfort and support for the lower back, under knees and under ankles by relieving pressure

Code	Description	Length	Width	Height	DVA:
BEP056220	Quad Cushion	530 mm	260 mm	90 mm	AE02
BEP056221	Quad Cushion Replacement Slip Only				AE02

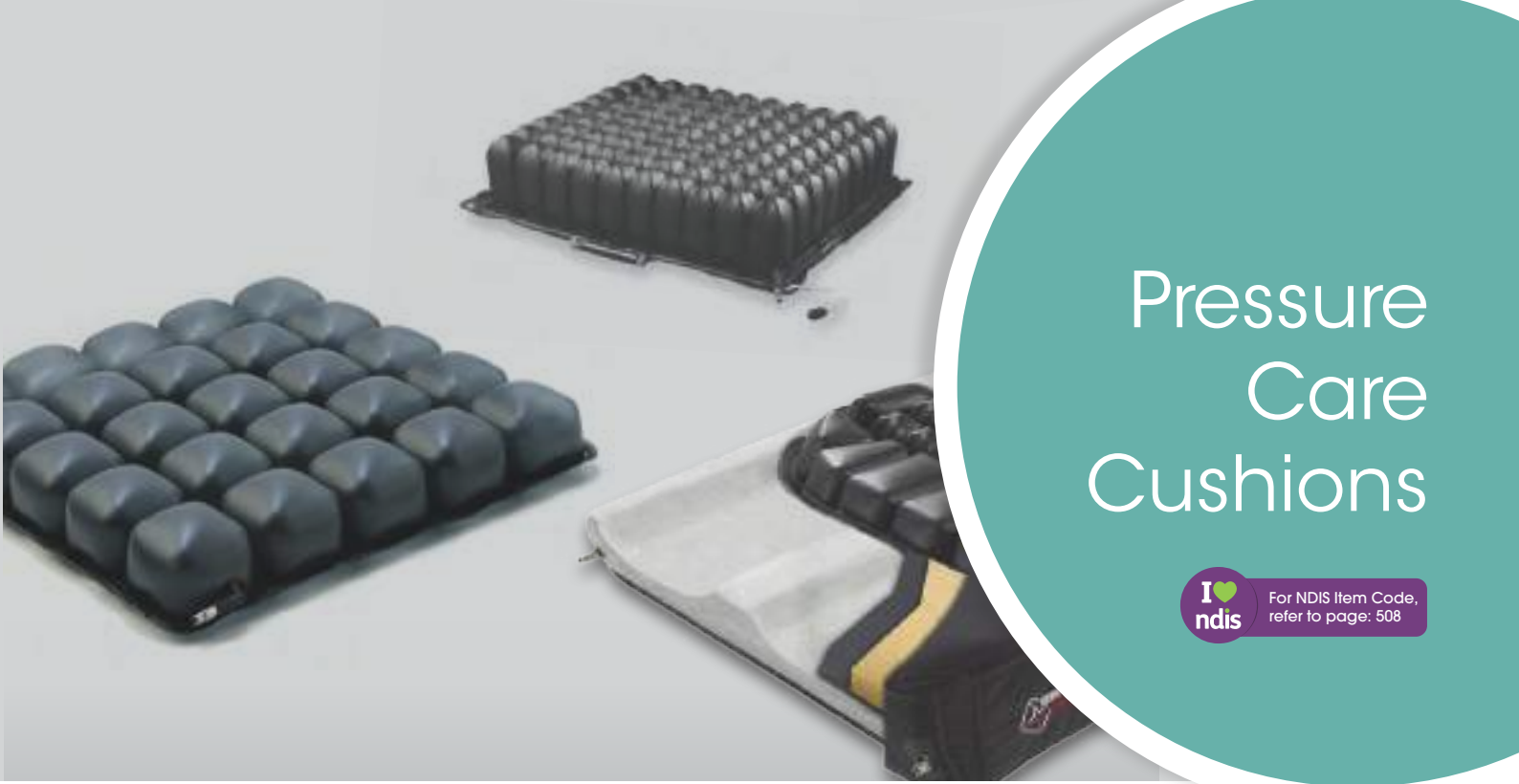

# Pressure Care Cushions

I ♥ ndis For NDIS Item Code, refer to page: 508

Air cushions lower soft tissue stresses to skin at risk of breakdown - they provide greater immersion of the buttocks which creates a much larger contact area for load transfer, comfort and pressure relief for protection against skin shear damage.

## Permobil - ROHO Cushions Selection Guide



### LEVEL OF PRESSURE CARE / RISK

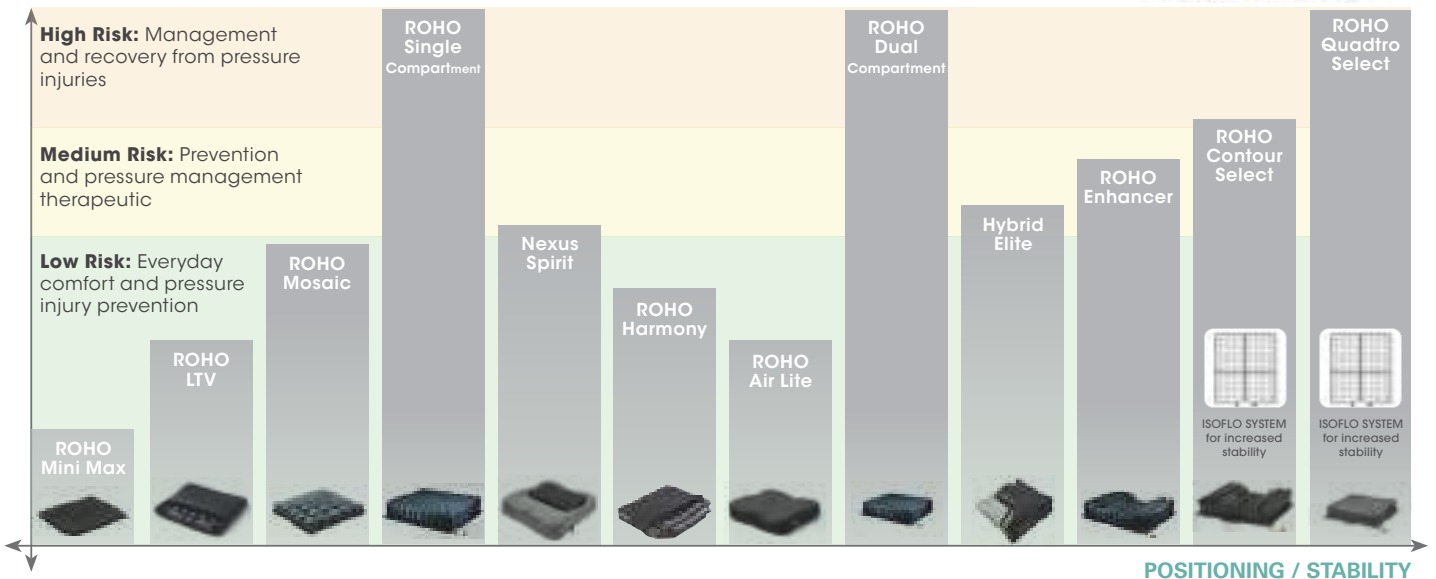

For Wheelchairs & Positioning Refer to Page 271

L Low Risk M Medium Risk H High Risk V Very High Risk





L

Note: Please contact Aidacare for enquiries relating to sizes outside of the displayed range.

### ROHO® - Mosaic

- Appropriate for everyday comfort and pressure injury prevention
- The Mosaic is excellent as a lounge-chair cushion and can also be used as a shower chair cushion
- Designed to provide a comfortable, functional and stable sitting environment for patients who are at risk of skin breakdown
- The Mosaic is also a Dry Floatation cushion but is made from softer plastic than the classic ROHO DF cushions. It is therefore lighter (0.5kg) but less rugged
- Interconnected air cells disperse pressure and promote stability as the pelvis sinks into them
- Maximum User Weight: 113kg

#### All models include

- 2 Way Stretch Cover
- Hand Pump & Repair Kit
- Operating Instructions
- 1 Year Warranty

DVA: AE04

WIDTH (Size")	DEPTH (Size")	
	18"	16"
18"	PTC586300	PTC586200
16"	-	PTC586100

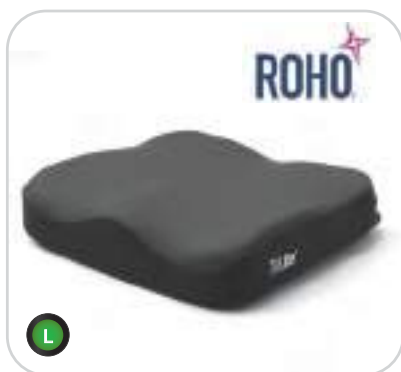

L

Note: This range can fit chairs from 14" x 14" to 20" x 20". Please contact Aidacare for enquiries relating to sizes outside of the displayed range.

Sizes listed are seat dimensions. The actual cushion is 1.5" longer to allow for the cushion to sit between the back canes.

### ROHO® - Air Lite

- Appropriate for everyday comfort and pressure injury prevention
- Designed for clients with tactile sensation who are at low risk of developing skin breakdown
- Contoured foam base with an internal sealed air cell provides comfort and support for basic positioning and pressure management needs
- Maximum User Weight: 113kg

#### All models include

- 2 Way Stretch Cover
- Hand Pump & Repair Kit
- Operating Instructions
- 1 Year Warranty

WIDTH (Size")	DEPTH (Size")					
	20"	18"	17"	16"	15"	14"
20"	-	PTC551450	-	-	-	-
18"	PTC551430	PTC551400	-	PTC551380	-	-
17"	-	PTC551330	PTC551325	-	-	-
16"	-	PTC551300	-	PTC551310	-	-
15"	-	-	-	-	PTC551295	-
14"	-	-	-	PTC551290	-	PTC551285



L

Note: This range can fit chairs from 13" x 15" to 20" x 20". Please contact Aidacare for enquiries relating to sizes outside of the displayed range.

### ROHO® - Contour Base

- Designed to provide a solid foundation to sling-seat wheelchairs
- Fits under the cushion inside the ROHO cushion-cover
- Made from moulded lightweight plastic (0.7kg) the base promotes postural integrity by improving symmetrical seating, preventing rotation of the femurs and providing forward pelvic stability

WIDTH (Size")	DEPTH (Size")		
	18"	17"	15"
20"	-	PTC541505	-
18"	-	-	PTC541390
17"	PTC541300	-	PTC541280
16"	-	-	PTC541210
15"	-	-	PTC541200

Low Risk Medium Risk High Risk Very High Risk

#### General Enquiries

P 1300 133 120 | E sales@aidacare.com.au | W www.aidacare.com.au



Note: This range can fit chairs from 15" x 15" to 20" x 16". Please contact Aidacare for enquiries relating to sizes outside of the displayed range.

Sizes listed are seat dimensions. The actual cushion is 1.5" longer to allow for the cushion to sit between the back canes.

### ROHO® - Mini Max

- Appropriate for everyday comfort and pressure injury prevention
- Designed for short-term needs of users with high comfort needs but at low-level risk of skin breakdown
- Inter-connected air cells provide shock absorption and pressure reduction
- Lightweight: At 0.9kg the Mini Max cushion adds minimal weight to the entire mobility solution
- Great for travel and sports

DVA: AE04

#### All models include

- 2 Way Stretch Cover
- Hand Pump & Repair Kit
- Operating Instructions
- 1 Year Warranty

WIDTH (Size")	DEPTH (Size")	
	16"	15"
18"	PTC586000	-
16"	PTC585900	-
15"	-	PTC585800

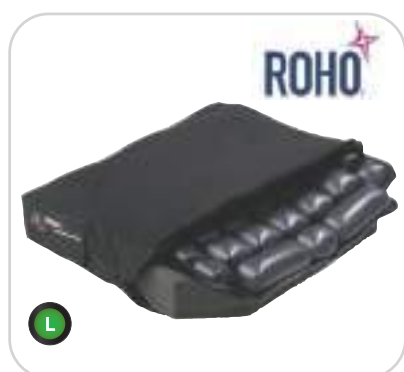

Note: This range can fit chairs from 14" x 16" to 20" x 18". Please contact Aidacare for enquiries relating to sizes outside of the displayed range.

Sizes listed are seat dimensions. The actual cushion is 1.5" longer to allow for the cushion to sit between the back canes.

### ROHO® - Harmony

- Appropriate for clients with moderate to low risk of skin breakdown who require a lightweight solution and that provides stability
- Stability: The Harmony cushion is built on an anatomically shaped foam base that enhances stability for the user
- Pressure: A ROHO Air Floatation cushion on top of the foam base provides comfort and pressure support for longer sitting times
- Lightweight: At 0.7kg the Harmony cushion adds minimal weight to the entire mobility solution
- Moisture resistant cover protects the foam insert
- Maximum User Weight: 113kg

DVA: AE04

#### All models include

- 2 Way Stretch Cover
- Hand Pump & Repair Kit
- Operating Instructions
- 1 Year Warranty

WIDTH (Size")	DEPTH (Size")	
	18"	16"
20"	PTC555100	-
18"	PTC555000	PTC554900
17"	PTC554800	PTC554700
16"	PTC554600	PTC554500
14"	-	PTC554400

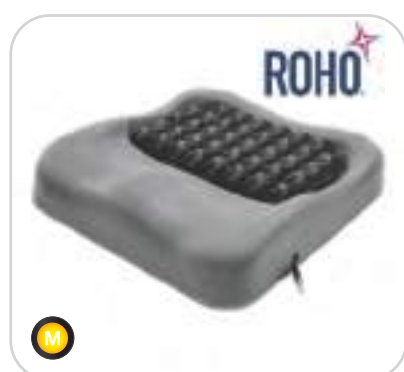

Note: This range can fit chairs from 14" x 14" to 20" x 18". Please contact Aidacare for enquiries relating to sizes outside of the displayed range.

Sizes listed are seat dimensions.

### ROHO® - Nexus Spirit

- Appropriate for clients with medium risk of ischaemic ulcers and need for positioning and transfer support
- Combines the stability of a contoured foam base with a ROHO Dry Floatation cushion for therapeutic care
- Posture: The contoured foam base provides increased stability for transfers and also provides excellent pelvic positioning for improved posture
- Pressure: The ROHO Dry Floatation insert protects the Coccyx and Ischia whilst the soft foam aids protection of the gluteal crease area
- Soft polyurethane seating foam and neoprene rubber ROHO pad

#### All models include

- 2 Way Stretch Cover
- Hand Pump & Repair Kit
- Operating Instructions
- 2 Years Warranty

DVA: AE04

WIDTH (Size")	DEPTH (Size")				
	18"	17"	16"	15"	14"
20"	PTC587300	-	-	-	-
18"	PTC587200	-	PTC587100	-	-
17"	-	PTC587000	-	-	-
16"	PTC586900	-	PTC586800	-	-
15"	-	-	-	PTC586700	-
14"	-	-	PTC586600	-	PTC586500

Low Risk Medium Risk High Risk Very High Risk

#### DVA Contact Details

P 1300 888 052 | F 1300 787 052 | E [dva@aidacare.com.au](mailto:dva@aidacare.com.au)

For NDIS Item Code, refer to page: 508

aidacare  
HEALTHCARE EQUIPMENT

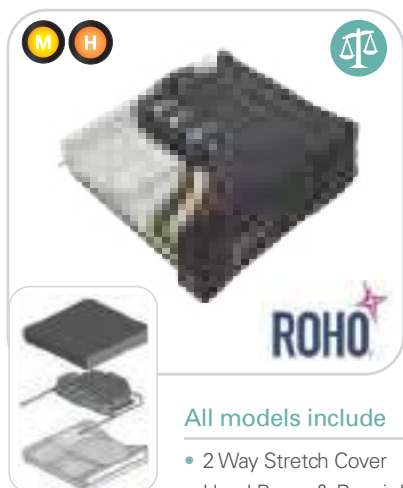

### All models include

- 2 Way Stretch Cover
- Hand Pump & Repair Kit
- Operating Instructions
- 2 Years Warranty

Note: This range can fit chairs from 14" x 14" to 20" x 20". Please contact Aidacare for enquiries relating to sizes outside of the displayed range.

Sizes listed are seat dimensions. The actual cushion is 1.5" longer to allow for the cushion to sit between the back canes.

## ROHO® - Hybrid Elite

- Appropriate for clients with moderate to high risk of skin breakdown who require positioning support
- The Hybrid Elite combines the skin protection and shape matching ability of ROHO Dry Floatation with a contoured foam base
- The design allows for improved pelvic alignment and stability while maintaining optimal immersion and dispersion of pressure away from the pelvic area
- The ROHO Dry Floatation system and 2-way stretch cover help reduce friction and shear whilst maximising blood flow
- The stability provided by the foam base assists "friction & shear" with safer transfers
- Maximum User Weight: 225kg

DVA: AE04

\* DVA contracted with Cover

WIDTH (Size")	VALVETYPE	DEPTH (Size")					
		20"	18"	17"	16"	15"	14"
20"	Single Valve	PTC594951	PTC594950	-	-	-	-
	Double Valve	PTC594961	PTC594955	-	-	-	-
18"	Single Valve	PTC594945	PTC594940	PTC594939	PTC594935	-	-
	Double Valve	PTC594972	PTC594954	PTC594959	PTC594958	-	-
17"	Single Valve	-	PTC594931	PTC594930	PTC594929	-	-
	Double Valve	-	PTC594971	PTC594970	PTC594957	-	-
16"	Single Valve	PTC594921	PTC594920	PTC594911	PTC594910	PTC594909	-
	Double Valve	PTC594963	PTC594953	PTC594969	PTC594952	PTC594968	-
15"	Single Valve	-	-	PTC594901	PTC594900	PTC594899	-
	Double Valve	-	-	PTC594967	PTC594966	PTC594956	-
14"	Single Valve	-	-	-	PTC594860	PTC594850	PTC594845
	Double Valve	-	-	-	PTC594965	PTC594964	PTC594962

Cushions & Seating

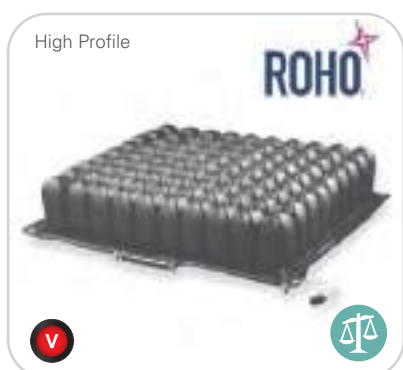

Note: This range can fit chairs from 13" x 13" to 22" x 22". Please contact Aidacare for enquiries relating to sizes outside of the displayed range.

Sizes listed are seat dimensions.



ISOFL0 - Open



ISOFL0 - Closed

### All models include

- 2 Way Stretch Cover
- Hand Pump & Repair Kit
- Operating Instructions
- 3 Years Warranty

## ROHO® Quadtro Select

- Appropriate for clients at very high risk of ischaemic ulcers and for management and recovery from existing pressure injury conditions
- ROHO Dry Floatation promotes circulation, and pressure relief whilst flexible neoprene cells reduce shear friction
- Quick-and-easy air compartment adjustment maximises function and utility
- Quadtro Select cushions employ ISOFLO Memory Control which locks air into compartments to help maintain better postural integrity in addition to pressure reduction
- Maximum User Weight: Unlimited

### High Profile (HP)

- 4" (10cm) High Cells
- Higher Pressure Disbursement

### Mid Profile (MP)

- 3" (8.5) High Cells
- Sensor Ready Cushion

### Low Profile (LP)

- 2" (5cm) High Cells
- Greater Stability

DVA: AE04

WIDTH (Cells / Size")	Profile	DEPTH (Cells / Size")					
		12 / 22"	11 / 20"	10 / 18.5"	9 / 16.75"	8 / 15"	7 / 13"
12 / 22"	HP	PTC589900	PTC589800	PTC589600	PTC589550	-	-
	LP	-	-	PTC589700	-	-	-
11 / 20"	HP	PTC589200	PTC589000	PTC588800	PTC589400	PTC589300	-
	LP	PTC589210	PTC589100	PTC588900	PTC589500	-	-
10 / 18.5"	HP	-	PTC588000	PTC587700	PTC588500	PTC588300	-
	LP	PTC588210	PTC588100	PTC587900	PTC588700	PTC588400	PTC588280
9 / 16.75"	HP	-	PTC592400	PTC592200	PTC593000	PTC592800	-
	LP	-	-	PTC593220	-	-	-
8 / 15"	HP	-	PTC592500	PTC592300	PTC593200	PTC592900	-
	LP	-	PTC591500	PTC591300	PTC592000	PTC591800	PTC591600
7 / 13"	HP	-	-	-	-	PTC591900	PTC591700
	LP	-	-	-	-	PTC591000	PTC590700
						PTC591100	PTC590800

### General Enquiries

P 1300 133 120 | E sales@aidacare.com.au | W www.aidacare.com.au



### ROHO® - Enhancer

- Appropriate for clients with high risk of ischaemic ulcers and need for greater positioning support
- A unique combination of high(4"), mid(3") and low(2") profile cells in the one cushion centre the user and position the pelvis back in the wheelchair providing greater lateral stability through channelling of the legs
- A two-valve system allows the user to (1) adjust the interior "bucket" section for reduced pressure on the ischia and coccyx; and (2) adjust the outer perimeter for enhanced stability and positioning
- Soft neoprene construction is flame retardant and durable
- Maximum User Weight: Unlimited



DVA: AE04

Note: This range can fit chairs from 11.5" x 11.5" to 20.25" x 20.25". Please contact Aidacare for enquiries relating to sizes outside of the displayed range.

Sizes listed are seat dimensions.

#### All models include

- 2 Way Stretch Cover
- Hand Pump & Repair Kit
- Operating Instructions
- 2 Years Warranty

WIDTH (Cells / Size")	DEPTH (Cells / Size")			
	11 / 20.25"	10 / 18.5"	9 / 16.75"	8 / 15"
11 / 20.25"	-	PTC553060	-	-
10 / 18.5"	PTC553090	PTC553100	PTC553200	-
9 / 16.75"	-	PTC553500	PTC553600	PTC553550
8 / 15"	-	-	PTC553400	PTC553300



### ROHO® - Contour Select

- Appropriate for clients with high risk of ischaemic ulcers and need for greater positioning support
- A unique combination of high(4"), mid(3") and low(2") profile cells in the one cushion centre the user and position the pelvis back in the wheelchair providing greater lateral stability through channelling of the legs
- ISOFLO Memory Control locks air into compartments to help maintain better postural integrity in addition to pressure reduction
- Interconnected cells help disburse pressure and reduce shear risk promoting pressure management
- Soft neoprene construction is flame retardant and durable
- Maximum User Weight: Unlimited



DVA: AE04

Note: This range can fit chairs from 15" x 13" to 20" x 20". Please contact Aidacare for enquiries relating to sizes outside of the displayed range.

Sizes listed are seat dimensions.

#### All models include

- 2 Way Stretch Cover
- Hand Pump & Repair Kit
- Operating Instructions
- 3 Years Warranty

WIDTH (Cells / Size")	DEPTH (Cells / Size")			
	11 / 20"	10 / 18.5"	9 / 16.75"	8 / 15"
11 / 20"	PTC594000	PTC593900	PTC593890	-
10 / 18.5"	PTC593700	PTC593500	PTC593800	-
9 / 16.75"	PTC594400	PTC594300	PTC594700	PTC594600
8 / 15"	-	PTC594210	PTC594200	PTC594100



### ROHO® - LTV

- Appropriate for everyday comfort and pressure injury prevention
- Interconnected air-filled cells to redistribute body weight and minimise pressure
- Padded cover or optional synthetic leather cover adds an extra level of comfort
- Lightweight design and air valve make it easy to fold and great for travel

- Height adjustable 1 - 2"
- 1 Year Warranty

DVA: AE04

DEPTH (Size")	
WIDTH (Size")	17"
19"	PTC585200

Low Risk Medium Risk High Risk Very High Risk

#### DVA Contact Details

P 1300 888 052 | F 1300 787 052 | E [dva@aidacare.com.au](mailto:dva@aidacare.com.au)



For NDIS Item Code, refer to page: 508



Note: This range can fit chairs from 13.25" x 13.25" to 22" x 22". Please contact Aidacare for enquiries relating to sizes outside of the displayed range.

Sizes listed are seat dimensions.

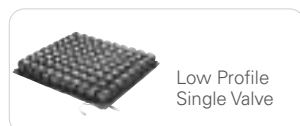

### All models include

- 2 Way Stretch Cover
- Hand Pump & Repair Kit
- Operating Instructions
- 2 Years Warranty



## ROHO® - Single Compartment

- Appropriate for clients with very high risk of ischaemic ulcers and for management and recovery from existing pressure injury conditions
- Interconnected cells help disperse pressure and reduce shear risk promoting pressure management
- Offers all the benefits of ROHO Dry Floatation but with less postural control and flexibility than offered by the Dual Compartment and Quadro Select ranges
- Soft neoprene construction is flame retardant and durable
- Maximum User Weight: Unlimited

### High Profile (HP) V

- 4" (10cm) High Cells
- Higher Pressure Disbursement

### Mid Profile (MP) V

- 3" (8.5) High Cells
- Sensor Ready Cushion

### Low Profile (LP) H

- 2" (5cm) High Cells
- Greater Stability

✓ DVA: AE04

WIDTH (Cells / Size")	Profile	DEPTH (Cells / Size")					
		12 / 22"	11 / 20.25"	10 / 18.5"	9 / 16.75"	8 / 15"	7 / 13.25"
12 / 22"	HP	-	PTC544560	PTC544500	PTC544420	-	-
	LP	PTC544600	PTC544590	PTC544550	PTC544430	-	-
11 / 20.25"	HP	PTC544360	PTC544300	PTC544200	PTC544400	PTC544180	-
	MP	-	PTC548608	PTC548607	-	-	-
10 / 18.5"	HP	PTC543920	PTC543900	PTC543700	PTC544000	PTC543980	PTC543970
	MP	-	PTC548605	PTC548604	PTC548603	-	-
9 / 16.75"	HP	PTC546210	PTC546100	PTC545900	PTC546600	PTC546500	PTC546450
	MP	-	PTC548602	PTC548601	PTC548600	-	-
8 / 15"	HP	-	-	PTC545301	PTC545700	PTC545500	PTC545400
	LP	-	-	PTC545300	PTC545800	PTC545600	-
7 / 13.25"	HP	-	-	PTC545220	PTC545200	PTC545120	PTC545100
	LP	-	-	-	PTC545210	PTC545130	PTC545110

## ROHO® - Dual Compartment

- Appropriate for clients with very high risk of ischaemic ulcers and for management and recovery from existing pressure injury conditions
- Two separate compartments of the cushion allow positioning adjustments to address a pelvic obliquity (side-to-side) or sacral sitting (front to back)
- The Dual Compartment offers slightly less postural control and flexibility than the Quadro Select range but retains the pressure and shear risk management standard for ROHO
- Maximum User Weight: Unlimited

### High Profile (HP) V

- 4" (10cm) High Cells
- Higher Pressure Distribution

### Low Profile (LP) H

- 2" (5cm) High Cells
- Greater Stability

✓ DVA: AE04



Note: This range can fit chairs from 13.25" x 13.25" to 20.25" x 20.25". Please contact Aidacare for enquiries relating to sizes outside of the displayed range.

Sizes listed are seat dimensions. The actual cushion is 1.5" longer to allow for the cushion to sit between the back canes.



Low Profile Dual Valve With Cover

### All models include

- 2 Way Stretch Cover
- Hand Pump & Repair Kit
- Operating Instructions
- 2 Years Warranty

WIDTH (Cells / Size")	Profile	DEPTH (Cells / Size")				
		11 / 20.25"	10 / 18.5"	9 / 16.75"	8 / 15"	7 / 13.25"
10 / 20.25"	HP	PTC547270	PTC547280	-	-	-
	LP	PTC547275	PTC547285	-	-	-
10 / 18.5"	HP	PTC547290	PTC547300	PTC547500	-	PTC547510
	LP	PTC547295	PTC547400	PTC547505	-	-
9 / 16.75"	HP	-	PTC548000	PTC548400	PTC548200	-
	LP	-	PTC548100	PTC548500	PTC548300	-
8 / 15"	HP	-	-	PTC547800	PTC547600	PTC547550
	LP	-	-	PTC547900	PTC547700	PTC547551
7 / 13.25"	HP	-	-	-	PTC547540	PTC547535
	LP	-	-	-	PTC547541	PTC547536

L Low Risk M Medium Risk H High Risk V Very High Risk



### Dreamline Assist

- Incorporating the signature BUBBLE TECHNOLOGY, the Dreamline ASSIST cushion is a comfortable solution for full time wheelchair users who have good stability and a low risk of skin breakdown
- 4-way stretch water-resistant incontinence cover and an outer breathable moisture wicking cover
- Includes a set of 4 positioning pads for pelvic obliquity
- 15mm high contouring
- 2 year warranty
- Max user weight: 120kg

WIDTH (inches")	DEPTH (inches")								
	8"	10"	12"	14"	16"	18"	20"	22"	24"
8"	PTC620200	PTC620210	-	-	-	-	-	-	-
10"	-	PTC620220	PTC620230	-	-	-	-	-	-
12"	-	-	PTC620240	PTC620250	-	-	-	-	-
14"	-	-	-	PTC620260	PTC620270	PTC620280	-	-	-
16"	-	-	-	-	PTC620290	PTC620300	PTC620310	-	-
18"	-	-	-	-	PTC620320	PTC620330	PTC620340	-	-
20"	-	-	-	-	-	PTC620350	PTC620360	-	-
22"	-	-	-	-	-	PTC620370	PTC620380	PTC620390	-
24"	-	-	-	-	-	-	PTC620400	PTC620410	PTC620420

Custom sizes also available on request



### Dreamline Support

- The Dreamline SUPPORT cushion has the same design as the ASSIST Cushion but with enhanced contouring for extra weight distribution and support
- 4-way stretch water-resistant incontinence cover and an outer breathable moisture wicking cover
- Includes a set of 4 positioning pads for pelvic obliquity
- 35mm high contouring
- 2 year warranty
- Max user weight: 120kg

WIDTH (inches")	DEPTH (inches")								
	8"	10"	12"	14"	16"	18"	20"	22"	24"
8"	PTC620500	PTC620510	-	-	-	-	-	-	-
10"	-	PTC620520	PTC620530	-	-	-	-	-	-
12"	-	-	PTC620540	PTC620550	-	-	-	-	-
14"	-	-	-	PTC620560	PTC620570	PTC620580	-	-	-
16"	-	-	-	-	PTC620590	PTC620600	PTC620610	-	-
18"	-	-	-	-	PTC620620	PTC620630	PTC620640	-	-
20"	-	-	-	-	-	PTC620650	PTC620660	-	-
22"	-	-	-	-	-	PTC620670	PTC620680	PTC620690	-
24"	-	-	-	-	-	-	PTC620700	PTC620710	PTC620720

Custom sizes also available on request



### Dreamline Contour

- The Dreamline CONTOUR cushion has the highest contouring of the BUBBLE TECHNOLOGY series, offering excellent weight distribution and stability
- It is a comfortable solution for full time wheelchair users who have reduced stability and low-to-moderate risk of skin breakdown
- Includes a set of 4 positioning pads for pelvic obliquity
- 4-way stretch water-resistant incontinence cover and an outer breathable moisture wicking cover
- 60mm high contouring
- 2 year warranty
- Max user weight: 120kg

WIDTH (inches")	DEPTH (inches")								
	8"	10"	12"	14"	16"	18"	20"	22"	24"
8"	PTC620800	PTC620810	-	-	-	-	-	-	-
10"	-	PTC620820	PTC620830	-	-	-	-	-	-
12"	-	-	PTC620840	PTC620850	-	-	-	-	-
14"	-	-	-	PTC620860	PTC620870	PTC620880	-	-	-
16"	-	-	-	-	PTC620890	PTC620900	PTC620910	-	-
18"	-	-	-	-	PTC620920	PTC620930	PTC620940	-	-
20"	-	-	-	-	-	PTC620950	PTC620960	-	-
22"	-	-	-	-	-	PTC620970	PTC620980	PTC620990	-
24"	-	-	-	-	-	-	PTC621000	PTC621010	PTC621020

Custom sizes also available on request

**L** Low Risk **M** Medium Risk **H** High Risk **V** Very High Risk





### Dreamline G3

- The Dreamline G3 cushion is a redefined gel cushion with mild contouring, designed for an active user with moderate-to-high pressure management needs
- The G3 Cushion offers the support and benefit of gel without the maintenance and potential risks of a traditional gel cushion
- 4-way stretch water-resistant incontinence cover and a outer breathable moisture wicking cover
- Unique and patented gel cluster packs for maximum skin protection
- Includes a set of 10 BAC pads for pelvic obliquity
- 60mm high contouring with reinforced inserts to bolster the pommel and lateral regions
- 2 year warranty
- Max user weight: 140kg



GEL WIDTH (inches")	DEPTH (inches")					
	12"	14"	16"	18"	20"	22"
12"	PTC621300	PTC621310	-	-	-	-
14"	-	PTC621320	PTC621330	PTC621340	-	-
16"	-	-	PTC621350	PTC621360	PTC621370	-
18"	-	-	-	PTC621380	PTC621390	PTC621400
20"	-	-	-	-	PTC621410	-

FOAM WIDTH (inches")	DEPTH (inches")					
	12"	14"	16"	18"	20"	22"
12"	PTC621100	PTC621110	-	-	-	-
14"	-	PTC621120	PTC621130	PTC621140	-	-
16"	-	-	PTC621150	PTC621160	PTC621170	-
18"	-	-	-	PTC621180	PTC621190	PTC621200
20"	-	-	-	-	PTC621210	-

Custom sizes also available on request



### Dreamline STX

- The Dreamline STX cushion is a fully adjustable cushion with full height contouring, designed for inactive users who have asymmetrical positioning requirements and high pressure management needs
- The STX Cushion provides the end user the highest amount of adjustability without compromise
- A closed cell foam base for maximum stability with adjustable components
- Includes a set of 10 BAC pads for pelvic obliquity
- 4-way stretch water-resistant incontinence cover and a outer breathable moisture wicking cover
- 80mm high contouring
- Adjustable foam / gel cluster packs
- 2 year warranty
- Max user weight: 140kg



GEL WIDTH (inches")	DEPTH (inches")					
	12"	14"	16"	18"	20"	22"
12"	PTC621700	PTC621710	-	-	-	-
14"	-	PTC621720	PTC621730	PTC621740	-	-
16"	-	-	PTC621750	PTC621760	PTC621770	-
18"	-	-	-	PTC621780	PTC621790	PTC621800
20"	-	-	-	-	PTC621810	-

FOAM WIDTH (inches")	DEPTH (inches")					
	12"	14"	16"	18"	20"	22"
12"	PTC621500	PTC621510	-	-	-	-
14"	-	PTC621520	PTC621530	PTC621540	-	-
16"	-	-	PTC621550	PTC621560	PTC621570	-
18"	-	-	-	PTC621580	PTC621590	PTC621600
20"	-	-	-	-	PTC621610	-

Custom sizes also available on request

### Dreamline Range Accessories

	Description
1	Cushion Gel Wrap
2	Incontinence cover
3	Extra Positioning Pads
4	STX Laterals
5	STX Pre-ischial Wedge
6	STX Gel Cluster Pack
7	STX Pommel Left/Right
8	STX Lateral Segments - 2"/3"/4"
9	STX Thigh Wedge
10	Outer Cover
11	STX Foam Cluster Pack
12	STX BAC Pads

Custom sizes also available on request



#### General Enquiries

P 1300 133 120 | E sales@aidacare.com.au | W www.aidacare.com.au



### Sunrise Medical - Jay Cushions Overview



**FS** Forward Stability   **LS** Lateral Stability   **P** Pressure Management

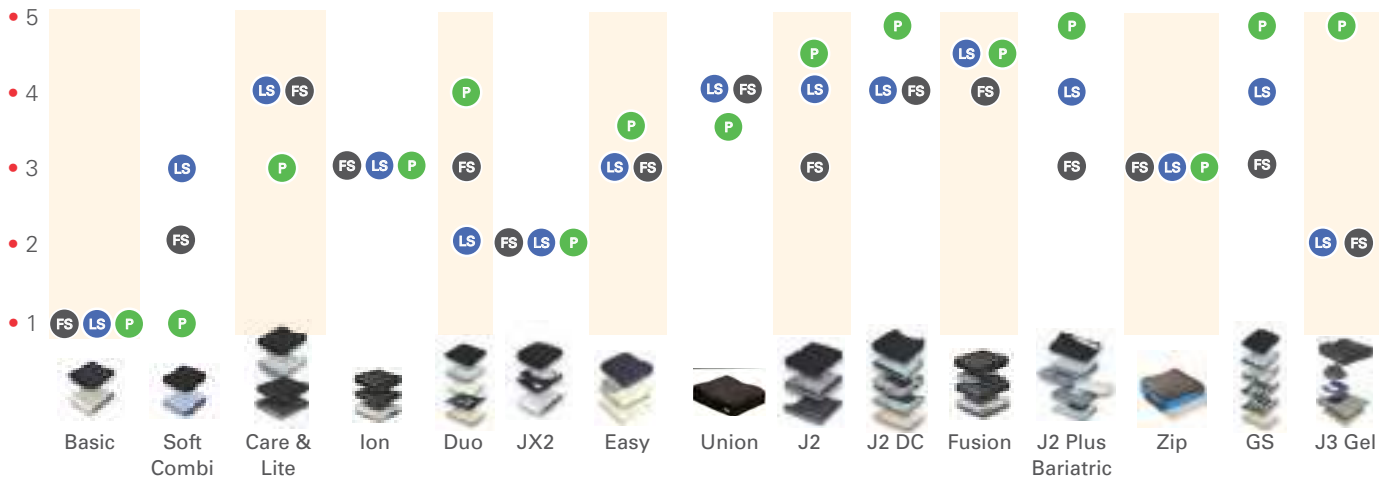

SPECIFIC APPLICATIONS: JAY DUO - Ideal for foot propulsion ; JAY CARE - Can accommodate a fixed posterior pelvic tilt ; J2 PLUS - 295kg weight capacity ; JAY ZIP / JAY GS - Paeds



Note: For sizes outside of the codes displayed, please contact your Aidacare Complex Rehab. consultant. (Refer to: Complex Rehab. Overview on pg 11)

#### JAY - Basic

- Designed for the client who has symmetrical postures needing minimal postural support
- Durable pre-contoured foam provides lateral stability; encourages orthopaedic alignment; and helps redistribute pressure to increase sitting tolerance
- Most suitable for clients with low risk of skin breakdown

#### All models include

- Incontinence resistance cover
- 1 Year Warranty (6 Months on Cover)

Code	Chair Size (w x d)	Height (inches)	S.W.L	Warranty	DVA:
PTC567600	14 x 16"	2.5"	113 kg	1 Year	AE04
PTC568400	15 x 16"	2.5"	113 kg	1 Year	AE04
PTC567400	16 x 16"	2.5"	113 kg	1 Year	AE04
PTC567500	16 x 18"	2.5"	113 kg	1 Year	AE04
PTC568450	17 x 16"	2.5"	113 kg	1 Year	AE04
PTC566800	18 x 16"	2.5"	113 kg	1 Year	AE04
PTC566900	18 x 18"	2.5"	113 kg	1 Year	AE04
PTC567650	20 x 16"	2.5"	113 kg	1 Year	AE04
PTC567700	20 x 18"	2.5"	113 kg	1 Year	AE04
PTC567750	22 x 18"	2.5"	113 kg	1 Year	AE05
PTC566950	22 x 20"	2.5"	113 kg	1 Year	AE04



Note: For sizes outside of the codes displayed, please contact your Aidacare Complex Rehab. consultant. (Refer to: Complex Rehab. Overview on pg11)

#### JAY - Soft Combi

- Designed for the client who has symmetrical postures needing minimal to moderate postural support
- Pre-contoured foam base features a deeper leg trough and increased medial thigh support
- Provides mild lateral stability as well as mild to moderate forward/rearward stability
- Provides trochanteric support to distribute pressure away from the ischials
- Most suitable for clients with low risk of skin breakdown

#### Soft Combi (JB)

- Softer foam
- Higher pressure disbursement

#### With Lumbar Support

- Optional extra or as a kit

#### All models include

- Incontinence cover
- 5 Years Warranty (6 Months on Cover)

Code	Chair Size (w x d)	Height (inches)	S.W.L	Warranty
PTC573000	16 x 16"	3"	113 kg	5 Years
PTC572800	20 x 18"	3"	113 kg	5 Years

**L** Low Risk   **M** Medium Risk   **H** High Risk   **V** Very High Risk

#### DVA Contact Details

P 1300 888 052 | F 1300 787 052 | E [dva@aidacare.com.au](mailto:dva@aidacare.com.au)



For NDIS Item Code, refer to page: 508







Note: For sizes outside of the codes displayed, please contact your Aidacare Complex Rehab. consultant. (Refer to: Complex Rehab. Overview on pg 11)



### JAY - Lite

- An ideal off-the-shelf complement to ultra lightweight wheelchairs
- Constructed with lightweight 3DX Microclimatic spacer fabric and Airflow base to provide excellent microclimatic heat and moisture dissipation
- The OptiWell pelvic loading area helps to achieve high levels of pressure distribution and stability in an extremely lightweight cushion
- Available with positioning inserts for those with postural needs
- Available in sizes 14x14" to 24x24". Common sizes are shown below

#### All models include

- Micro-Climatic Cover
- 1 Year Warranty (6 Months on Cover)

Code	Chair Size (width x depth)	Height (inches)	S.W.L	Warranty	DVA:
PTC571902	14 x 14"	2.25"	113 kg	1 Year	AE04
PTC571901	14 x 16"	2.25"	113 kg	1 Year	AE04
PTC571906	15 x 15"	2.25"	113 kg	1 Year	AE04
PTC571970	15 x 16"	2.25"	113 kg	1 Year	AE04
PTC571911	16 x 16"	2.25"	113 kg	1 Year	AE04
PTC571913	16 x 18"	2.25"	113 kg	1 Year	AE04
PTC585155	18 x 18"	2.25"	113 kg	1 Year	AE04
PTC571925	20 x 18"	2.25"	113 kg	1 Year	AE04
PTC571950	22 x 18"	2.25"	113 kg	1 Year	AE04



- 1 Washable stretch cover
- 2 JAY fluid "Tripad" over foam base



### JAY - Care

- Most suitable for the sacral sitter, the Jay Care is designed for the client who has symmetrical posture needing moderate postural support
- The pre-contoured foam base provides a longer seat well to accommodate fixed "sacral sitting" where the ischials are positioned forward. Contours also provide moderate lateral and forward/rearward stability
- The reinforced curved bottom counteracts the negative effects associated with sling upholstery providing a level sitting surface
- The fluid-filled "Tripad" incorporates left/right/rear sections to maintain the fluid under at-risk bony areas
- Most suitable for the client at moderate risk of skin breakdown where independent weight shift is possible

#### All models include

- Washable Stretch Cover
- Incontinence Resist Inner Casing
- 2 Years Warranty (6 Months on Cover)

Code	Chair Size (width x depth)	Height (inches)	S.W.L	Warranty	DVA:
PTC568000	6 x 15.5"	2.5"	113 kg	2 Years	AE04
PTC568100	16 x 17.5"	2.5"	113 kg	2 Years	AE04
PTC567800	18 x 15.5"	2.5"	113 kg	2 Years	AE04
PTC567900	18 x 17.5"	2.5"	113 kg	2 Years	AE04
PTC568200	20 x 17.5"	2.5"	113 kg	2 Years	AE04





Note: For sizes outside of the codes displayed, please contact your Aidacare Complex Rehab. consultant. (Refer to: Complex Rehab. Overview on pg 11)

- 1 Lightweight Aluminium Base
- 2 Soft foam pre-contoured cushion
- 3 'Jay Flow' fluid pad
- 4 2-way stretch washable cover

### JAY - Duo

- Designed for the client who has symmetrical postures needing mild to moderate physical support
- The lightweight aluminium pre-contoured solid base attaches to chair rails effectively replacing the sling seat upholstery
- The aluminium base in combination with a soft foam & fluid cushion provides an anatomically correct, stable base of support that promotes postural stability
- The pre-contoured foam base of the Jay Duo provides mild lateral and forward/rearward stability and provides a base of support that promotes foot propelling or independent transfers
- The 'Jay Flow' fluid pad reduces the effects of shearing on the ischial tuberosities
- Most suitable for the client at moderate risk of skin breakdown who can ideally perform independent weight-shift

#### All models include

- 2 Way Stretch Cover
- 2 Years Warranty (6 Months on Cover)



Code	Chair Size (width x depth)	Height (inches)	S.W.L	Warranty	DVA:
PTC569200	16 x 16"	2.25"	113 kg	2 Years	AE04
PTC569300	16 x 18"	2.25"	113 kg	2 Years	AE04
PTC569500	17 x 18"	2.25"	113 kg	2 Years	AE04
PTC569000	18 x 16"	2.25"	113 kg	2 Years	AE04
PTC569100	18 x 18"	2.25"	113 kg	2 Years	AE04
PTC569400	20 x 18"	2.25"	113 kg	2 Years	AE04



Note: For sizes outside of the codes displayed, please contact your Aidacare Complex Rehab. consultant. (Refer to: Complex Rehab. Overview on pg 11)

- 1 Soft foam pre-contoured base
- 2 'Jay Flow' fluid tripad
- 3 JAY AirExchange cover

### JAY - Easy (Fluid & Visco)

- The Jay Easy is an economical cushion with design characteristics from the Jay Xtreme and Jay Care cushions
- Developed for individuals who require moderate positioning and pressure relief, the Jay Easy can be used with either a seat sling or a solid base
- The pre-contoured foam base features significant lateral and medial thigh contours for clients who require greater positioning
- Optional Curved base (for use on a seat sling) or a Flat base (for use on a solid seat pan or in combination with a solid insert)
- The rear of the cushion base features a sacral notch similar to the one in the Jay Xtreme base. This notch prevents tissue breakdown around the coccyx caused by bouncing or posterior pelvic tilt
- The 'Jay Flow' Fluid Tripad provides pressure relief and shear reduction for users who are at moderate risk for skin breakdown

#### All models include

- 2 Way Stretch Cover
- 2 Years Warranty (6 Months on Cover)



Code	Chair Size (width x depth)	Height (inches)	Pelvic Contour Width	S.W.L	Warranty	DVA:
PTC580004	14 x 16" (curved)	2.0"	12.50"	113 kg	2 Years	AE04
PTC580005	14 x 16" (flat)	2.0"	12.50"	113 kg	2 Years	AE04
PTC580100	15 x 15" (flat)	2.0"	12.50"	113 kg	2 Years	AE04
PTC580200	16 x 16" (curved)	2.0"	14.00"	113 kg	2 Years	AE04
PTC580300	16 x 16" (flat)	2.0"	14.00"	113 kg	2 Years	AE04
PTC580400	16 x 18" (curved)	2.0"	14.00"	113 kg	2 Years	AE04
PTC580350	17 x 17" (flat)	2.0"	14.00"	113 kg	2 Years	AE04
PTC580500	18 x 16" (curved)	2.0"	14.00"	113 kg	2 Years	AE04
PTC580600	18 x 18" (curved)	2.0"	14.00"	113 kg	2 Years	AE04



#### DVA Contact Details

P 1300 888 052 | F 1300 787 052 | E [dva@aidacare.com.au](mailto:dva@aidacare.com.au)

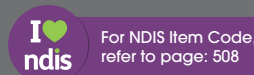



Note: For sizes outside of the codes displayed, please contact your Aidacare Complex Rehab. consultant. (Refer to: Complex Rehab. Overview on pg 11)

### Jay - Ion

- Dual-layered foam base with varying firmness
- Visco memory foam top layer
- Innovative, dual-cover system

#### All models include

- Dual Cover System
- 2 Years Warranty (6 Months on Cover)

Code	Chair Size (width x depth)	Height (inches)	S.W.L	Warranty
PTC573468	14" x 14"	4"	136 kg	2 Years
PTC573469	14" x 16"	4"	136 kg	2 Years
PTC573459	15" x 16"	4"	136 kg	2 Years
PTC573460	16" x 16"	4"	136 kg	2 Years
PTC573463	16" x 18"	4"	136 kg	2 Years
PTC573467	17" x 17"	4"	136 kg	2 Years
PTC573461	18" x 16"	4"	136 kg	2 Years
PTC573462	18" x 18"	4"	136 kg	2 Years
PTC573464	20" x 16"	4"	136 kg	2 Years
PTC573470	20" x 17"	4"	136 kg	2 Years
PTC573465	20" x 18"	4"	136 kg	2 Years
PTC573466	20" x 20"	4"	136 kg	2 Years



Note: For sizes outside of the codes displayed, please contact your Aidacare Complex Rehab. consultant. (Refer to: Complex Rehab. Overview on pg 11)

### Jay - Union

- Stable foam base and dual layer Visco foam in varying densities create the ideal combination of softness, support and pressure relief
- 'Jay Flow' fluid insert beneath foam fits to each user's unique pelvic contour
- Contoured base and lateral wedges promote lateral stability
- Pelvic Loading Area provides anterior/posterior stability

#### All models include

- Dual Cover System
- 2 Years Warranty (6 Months on Cover)

Code	Profile	Chair Size (width x depth)	Height (inches)	S.W.L	Warranty
PTC573420	Reduced	14" x 14"	3.5"	136 kg	2 Years
PTC573423	High	16" x 16"	4.5"	136 kg	2 Years
PTC573405	Low	16" x 16"	4.5"	136 kg	2 Years
PTC573432	Reduced	16" x 17"	3.5"	136 kg	2 Years
PTC573429	High	16" x 18"	4.5"	136 kg	2 Years
PTC573419	Reduced	17" x 17"	3.5"	136 kg	2 Years
PTC573431	Reduced	17" x 17"	3.5"	136 kg	2 Years
PTC573425	High	17" x 18"	4.5"	136 kg	2 Years
PTC573422	High	18" x 16"	4.5"	136 kg	2 Years
PTC573426	High	18" x 18"	4.5"	136 kg	2 Years
PTC573421	High	19" x 17"	4.5"	136 kg	2 Years
PTC573430	Reduced	19" x 19"	3.5"	136 kg	2 Years
PTC573424	High	20" x 17"	4.5"	136 kg	2 Years
PTC573418	High	20" x 18"	4.5"	136 kg	2 Years
PTC573427	High	22" x 24"	4.5"	227 kg	2 Years



Note: For sizes outside of the codes displayed, please contact your Aidacare Complex Rehab. consultant. (Refer to: Complex Rehab. Overview on pg 11)

### Jay - Zip (Paediatric)

- Dual layered contoured foam base
- Reticulated foam in the outer cover promotes air movement
- Soft and stretchable outer cover (available with coloured outer cover side bands - option)

#### All models include

- 2 Way Stretch Cover
- 2 Years Warranty (6 Months on Cover)

Code	Chair Size (width x depth)	Height (inches)	S.W.L	Warranty
PTC585184	10" x 10"	2.75"	75 kg	2 Years
PTC585193	12" x 12"	2.75"	75 kg	2 Years
PTC585185	12" x 16"	2.75"	75 kg	2 Years
PTC585192	14" x 14"	2.75"	75 kg	2 Years
PTC585190	14" x 16"	2.75"	75 kg	2 Years
PTC585191	15" x 15"	2.75"	75 kg	2 Years



### JAY - J2

- Designed for the client who has moderate to more aggressive postural needs that may change over time
- The J2 pre-contoured, closed-cell, lightweight, foam base provides excellent lateral and forward/rearward stability creating a foundation for postural stability
- The base fluid pad can be modified/customised on site to accommodate fixed postures or to correct flexible postures. Modifications can support changing needs over time
- Optional solid seat inserts provide extra postural stability discouraging the cushion from slinging with the chair upholstery
- Postural accessories such as medial and lateral thigh supports, lateral pelvic supports and pelvic obliquity supports can be added to the cushion
- The 'Jay Flow' fluid Tripad conforms to bony prominences, distributes pressure more evenly and reduces peak pressures. The Tripad design assists in maintaining fluid under the at-risk bony areas
- Most suitable for the client who is at higher risk of skin breakdown and who has poor skin integrity
- Ballistic Stretch & Incontinence cover also available

#### All models include

- Air Exchange Cover
- 2 Years Warranty (6 Months on Cover)



Note: The J2 series of cushions are customisable to suit the specific needs of your client. For sizes outside of the codes displayed and enquiries relating to customisations, please contact your Aidacare Complex Rehab. consultant.  
(Refer to: Complex Rehab. Overview on pg 11)

- 1 Closed-cell ultra-lightweight base
- 2 'Jay Flow' fluid Tripad
- 3 JAY AirExchange or Incontinence cover (optional)

Code	Chair Size (width x depth)	Height (inches)	S.W.L	Warranty	DVA:
PTC562500	16 x 16"	3"	113 kg	2 Years	AE04
PTC562700	16 x 18"	3"	113 kg	2 Years	AE04
PTC563800	17 x 17"	3"	113 kg	2 Years	AE04
PTC561100	18 x 16"	3"	113 kg	2 Years	AE04
PTC561300	18 x 18"	3"	113 kg	2 Years	AE04
PTC562100	18 x 20"	3"	113 kg	2 Years	AE04
PTC563700	20 x 16"	3"	113 kg	2 Years	AE04
PTC564100	20 x 18"	3"	113 kg	2 Years	AE04



### JAY - J2 Deep Contour (DC)

- The J2-DC takes the J2 to a higher level of pressure and postural management
- Cushion depth is increased in the DC from 3" to 4"
- Pelvic contour depth increases from 2.5" to 3"
- An optional solid drop-seat (shown - bottom) can be permanently attached to promote a level platform
- '3D Jay Flow' fluid Tripad provides 3" deep-immersion pressure and postural management
- The J2 DC is most suitable for the client who is at the highest level of risk for skin breakdown or who has very poor skin integrity
- Ballistic Stretch & Incontinence cover also available

#### All models include

- Air Exchange Cover
- 2 Years Warranty (6 Months on Cover)



- 1 Solid seat insert (optional)
- 2 Closed-cell ultra-lightweight base
- 3 Leg Trough modification for hip ROM.
- 4 '3D Jay Flow' fluid Tripad
- 5 JAY AirExchange or Incontinence covers (Optional)

Code	Chair Size (width x depth)	Height (inches)	S.W.L	Warranty	DVA:
PTC566000	16 x 16"	4"	114 kg	2 Years	AE04
PTC566100	16 x 18"	4"	114 kg	2 Years	AE04
PTC566400	17 x 17"	4"	114 kg	2 Years	AE04
PTC566600	18 x 16"	4"	114 kg	2 Years	AE04
PTC566700	18 x 18"	4"	114 kg	2 Years	AE04
PTC566500	18 x 20"	4"	114 kg	2 Years	AE04
PTC566150	20 x 16"	4"	114 kg	2 Years	AE04
PTC5665000	20 x 18"	4"	114 kg	2 Years	AE04

Note: The J2 Deep Contour series of cushions are customisable to suit the specific needs of your client. For sizes outside of the codes displayed and enquiries relating to customisations, please contact your Aidacare Complex Rehab. consultant.  
(Refer to: Complex Rehab. Overview on pg 11)



#### DVA Contact Details

P 1300 888 052 | F 1300 787 052 | E [dva@aidacare.com.au](mailto:dva@aidacare.com.au)



For NDIS Item Code, refer to page: 508





Note: For sizes outside of the codes displayed, please contact your Aidacare Complex Rehab. consultant. (Refer to: Complex Rehab. Overview on pg 11)

### Jay - Fusion

- Multi-layered, contoured foam base
- Pelvic loading area determined by common skeletal measurements
- Available with Jay Flow Fluid or ROHO Dry floatation air inserts

- Innovative, dual-cover system

#### All models include

- 2 Years Warranty (6 Months on Cover)

Code	Chair Size (width x depth)	Height (inches)	S.W.L	Warranty	DVA:
PTC571207	14" x 16"	4"	136 kg	2 Years	AE04
PTC571204	16" x 16"	4"	136 kg	2 Years	AE04
PTC571206	16" x 18"	4"	136 kg	2 Years	AE04
PTC571205	17" x 17"	4"	136 kg	2 Years	AE04



Note: The J2 Plus (Bariatric) series of cushions are customisable to suit the specific needs of your client. For sizes outside of the codes displayed and enquiries relating to customisations, please contact your Aidacare Complex Rehab. consultant. (Refer to: Complex Rehab. Overview on pg 11)

### JAY - J2 Plus (Bariatric)

- The Jay J2 Plus Cushion offers the bariatric client all the clinical benefits of the Jay J2 Cushion with a weight capacity of 295 kg
- Multiple insert selections: Allow therapists to customize the Jay J2 Plus Cushion. For patients who are at low risk for skin breakdown, both standard and custom foam packages are available. These packages feature layers of Visco foam that stack into the seat-well. For patients at high risk, fluid pad inserts are available
- Cover Choices: Tritex Air-Exchange cover which promotes cool-air movement or an incontinent-resistant low-shear cover that combines the benefits of incontinent resistance and low shear
- Urethane overlay cover: Protection from incontinence is an important feature in a bariatric cushion. The Jay J2 Plus Cushion offers a removable urethane overlay cover to further protect the cushion

- Anterior tilted base: Most bariatric patients have a problem with slumping forward. This is caused by the downward pull of their stomachs. By providing a slight anterior tilt to the cushion base, the hip angle is opened up enabling patients to sit more upright

#### All models include

- 2 Years Warranty (6 Months on Cover)



- 1 Closed-cell foam base with anterior tilt
- 2 13" Seat Well structure
- 3 Optional: Seat well inserts (gel or foam)
- 4 Urethane overlay cover
- 5 JAY Tritex AirExchange or Incontinence cover (optional)

Code	Chair Size (width x depth)	Height (inches)	S.W.L	Warranty	DVA:
PTC567000	20 x 18"	3.5"	295 kg	2 Years	AE04
PTC567002	20 x 20"	3.5"	295 kg	2 Years	AE04
PTC567004	20 x 22"	3.5"	295 kg	2 Years	AE04
PTC567050	21 x 19"	3.5"	295 kg	2 Years	AE04
PTC567100	22 x 18"	3.5"	295 kg	2 Years	AE04
PTC567200	22 x 20"	3.5"	295 kg	2 Years	AE04
PTC567250	22 x 22"	3.5"	295 kg	2 Years	AE04
PTC567300	24 x 18"	3.5"	295 kg	2 Years	AE04



Note: For sizes outside of the codes displayed, please contact your Aidacare Complex Rehab. consultant. (Refer to: Complex Rehab. Overview on pg 11)

### Jay - X2

- Lightweight, maintenance-free, fluid cushion
- A reduced profile that is designed to provide stability and pressure relief to active clients
- A notch at the rear of the cushion reduces pressure over the coccyx bone
- Removable, lateral thigh supports provide additional positioning (optional)

- An innovative dual cover system for convenience and protection

#### All models include

- 2 Years Warranty (6 Months on Cover)

Code	Chair Size (width x depth)	Height (inches)	S.W.L	Warranty
PTC561270	16 x 16	2.25"	136 kg	2 Years
PTC561271	16 x 18	2.25"	136 kg	2 Years
PTC561274	17 x 17	2.25"	136 kg	2 Years
PTC561272	18 x 18	2.25"	136 kg	2 Years



#### General Enquiries

P 1300 133 120 | E sales@aidacare.com.au | W www.aidacare.com.au



- 1 Solid seat insert (optional)
- 2 Polyethylene foam base with "anti-thrust"
- 3 Optional: Seat well reducers & abductor
- 4 'Jay Flow' fluid pad w/ abductor option
- 5 'Jay Flow' fluid pad w/o abductor option
- 6 Jay stretch cover

### JAY - GS (Paediatric)

- The Jay GS utilises technology developed for the Jay J2 cushion and adapts it to the specific needs of children
- The Jay GS design incorporates the technologies of the 'Jay Flow' fluid, and includes growth capabilities to allow the cushion to grow with the child
- This is the ideal cushion for the paediatric or adult client with high positioning needs who is a moderate to high risk for skin breakdown
- A variety of optional supports can position and maintain optimal pelvic and lower extremity posture
- Standard fluid pad provides shear reduction and improved pressure distribution for users at moderate risk

#### All models include

- Stretch Cover
- 2 Years Warranty (6 Months on Cover)



Code	Chair Size (width x depth)	Height (inches)	S.W.L	Warranty
PTC558800	10 x 13"	3"	113 kg	2 Years
PTC559000	12 x 15"	3"	113 kg	2 Years
PTC558700	14 x 17"	3"	113 kg	2 Years
PTC558500	16 x 19"	3"	113 kg	2 Years
PTC558300	18 x 20"	3"	113 kg	2 Years

Note: The JAY-GS series of cushions offers a wide range of optional cushion inserts to suit the specific needs of your client.

For sizes outside of the codes displayed and enquiries relating to customisations, please contact your Aidacare Complex Rehab. consultant. (Refer to: Complex Rehab. Overview on pg 11)



- 1 Solid seat insert (optional)
- 2 Closed-cell ultra-lightweight base
- 3 3 x PLA Size variations
- 4 4 x PLA insert variations. Jay Flow factory shown. Optional ROHO DRY FLOATATION® inserts
- 5 3 x Cover Options - all black

### JAY - J3 Gel or J3 Air w/ ROHO®

The Jay-J3 series of cushions are highly customisable to suit your client's needs.

Customisations cover 6 spectrums: (1) Cushion height; (2) Cushion width & depth; (3) PLA size (Pelvic Loading Area); (4) PLA insert choice (4 options); (5) Cover Options (3 options); (6) Positioning components.

We strongly recommend that you consult with your Aidacare Complex Rehab team member for any inquiries relating to these cushions. Refer: Complex Rehab overview on pg 11)

- The J3 features two models (1) the Gel and (2) the Air with ROHO DRY FLOATATION® insert (see below for more detail)
- The J3 range features outstanding pressure distribution, comfort, heat/moisture dissipation, and optimal stability
- With 230kg weight capacity the J3 is also a bariatric option.
- Pelvic loading area (PLA): Optimally shaped and sized to evenly distribute pressure under the pelvis. Available in 3 sizes, the PLA can be selected and sized to fit the user's pelvis regardless of the overall cushion width
- The PLA insert is available in four options: (1) Factory Filled JAY Flow™ fluid; (2) Field Variable JAY Flow fluid; (3) Air Single ROHO DRY FLOATATION® Technology; and, (4) Air Dual ROHO DRY FLOATATION® Technology. These four inserts provide two important benefits: hydrostatic loading (even distribution of load) and adjustability (in-field adjustment or custom factory adjustment) to ensure the best possible immersion, pressure distribution, and stability
- The J3 cushion features three cover options: (1) Stretch; (2) Microclimatic; or (3) Incontinent-resistant. All 3 covers are designed to minimise shear risks; provide comfort; and wick away heat and moisture
- The J3 is available with a wide range of positioning options to help the user maintain appropriate postural stability. Optional lateral and medial thigh supports as well as lateral pelvic supports are affixed securely to the cushion base



#### DVA Contact Details

P 1300 888 052 | F 1300 787 052 | E [dva@aidacare.com.au](mailto:dva@aidacare.com.au)



For NDIS Item Code, refer to page: 508





## Stealth - Solution SPP

- Lateral and pre-ischial shelf contoured, high-density molded foam base
- Twin-cell, aqueous gel insert under at risk bony areas
- CoolCore® technology cover standard.
- Urethane liner for incontinence
- Cushion height is 3"
- SWL 226kg

WIDTH (inches")	DEPTH (inches")								
	10"	12"	14"	16"	17"	18"	19"	20"	22"
10"	PTC622100	PTC622110	-	-	-	-	-	-	-
12"	PTC622120	PTC622130	-	-	-	-	-	-	-
14"	-	PTC622140	PTC622150	PTC622160	-	PTC622170	-	-	-
16"	-	-	-	PTC622180	PTC622190	PTC622200	PTC622210	PTC622220	-
17"	-	-	-	PTC622230	PTC622240	PTC622250	PTC622260	PTC622270	-
18"	-	-	-	PTC622280	-	PTC622290	PTC622300	PTC622310	PTC622320
19"	-	-	-	-	-	PTC622330	PTC622340	PTC622350	-
20"	-	-	-	PTC622360	-	PTC622370	PTC622380	PTC622390	PTC622400
22"	-	-	-	-	-	PTC622410	-	PTC622420	PTC622430
24"	-	-	-	-	-	-	-	PTC622440	PTC622450



## Stealth - Spectrum SPP

- Lateral and pre-ischial shelf contoured, high-density molded foam base
- CoolCore® technology cover standard
- Cushion height is 3"
- Foam: Multi-layer, viscoelastic foam insert under at risk bony areas
- Gel SWL 226kg, Foam SWL 295kg

WIDTH (inches")	DEPTH (inches")						
	16"	17"	18"	19"	20"	22"	24"
14"	-	-	PTC623100	-	-	-	-
16"	PTC623110	-	PTC623120	PTC623130	PTC623140	-	-
17"	PTC623150	PTC623160	PTC623170	PTC623180	PTC623190	-	-
18"	PTC623200	PTC623210	PTC623220	-	PTC623230	PTC623240	PTC623250
19"	-	PTC623260	PTC623270	PTC623280	PTC623290	-	-
20"	PTC623300	-	PTC623310	PTC623320	PTC623330	PTC623340	PTC623350
22"	PTC623360	-	PTC623370	PTC623380	PTC623390	PTC623400	PTC623410
24"	PTC623420	-	PTC623430	-	PTC623440	PTC623450	PTC623460

WIDTH (inches")	DEPTH (inches")								
	16"	17"	18"	19"	20"	22"	24"	26"	28"
16"	PTC622500	-	PTC622510	-	PTC622520	-	-	-	-
17"	-	PTC622530	PTC622540	PTC622550	-	-	-	-	-
18"	PTC622560	-	PTC622570	-	PTC622580	PTC622590	-	-	-
19"	-	PTC622600	-	PTC622610	-	-	-	-	-
20"	PTC622620	-	PTC622630	-	PTC622640	PTC622650	PTC622660	-	-
22"	-	-	PTC622670	-	PTC622680	PTC622690	PTC622700	-	-
24"	PTC622710	-	PTC622720	-	PTC622730	PTC622740	PTC622750	-	-
26"	-	-	PTC622760	-	PTC622770	PTC622780	PTC622790	-	-
28"	-	-	PTC622800	-	PTC622810	PTC622820	PTC622830	-	PTC622840
30"	-	-	PTC622850	-	PTC622860	PTC622870	PTC622880	-	PTC622890
32"	-	-	-	-	-	-	-	PTC622900	PTC622910

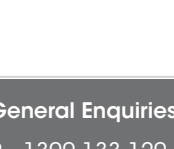

## Stealth - Tru-Comfort 2 SPP

- Deep contoured, high-density molded foam base
- CoolCore® Technology cover standard.
- Easy pull rubber loop zipper handles
- Convenient side pouches
- Cushion height is 4.5"
- SWL is 204kg

WIDTH (inches")	DEPTH (inches")					
	14"	16"	18"	20"	22"	24"
16"	PTC623500	PTC623510	PTC623520	PTC623530	-	-
18"	-	PTC623540	PTC623550	PTC623560	PTC623570	-
20"	-	PTC623580	PTC623590	PTC623600	PTC623610	PTC623620
22"	-	-	PTC623630	PTC623640	PTC623650	PTC623660

L Low Risk
 M Medium Risk
 H High Risk
 V Very High Risk



### Ottobock - Advantage

- Pressure reducing wheelchair seat cushion
- Filled with Floam® cells (Floam® is a fluid polymeric gel)
- Contoured foam base with raised abduction area for improved individual seating position
- Floam® cells are located where pressure relief is needed most

Code	Chair Size (width x depth)	Height (inches)	DVA:
PTC550050	16 x 16"	3"	AE04
PTC550075	16 x 18"	3"	AE04
PTC550100	18 x 16"	3"	AE04
PTC550150	18 x 18"	3"	AE04

Note: This range can fit chairs from 13 x 13" to 18 x 18". Please contact Aidacare for enquiries relating to sizes outside of the displayed range. Custom made sizes are also available upon request.



### Ottobock - Cloud

- Antidecubitus wheelchair seat cushion
- Filled with three different sizes of Floam® cells (Floam® is a fluid polymeric gel)
- Can be individually adapted according to the user's requirements by exchanging the cells
- Floam® side cells provide additional support
- Targeted pressure relief, reduced shearing forces
- SWL 250kg

Code	Chair Size (width x depth)	Height (inches)	S.W.L	DVA:
PTC549100	14 x 14"	4"	250 kg	AE04
PTC549200	15 x 16"	4"	250 kg	AE04
PTC549300	16 x 16"	4"	250 kg	AE04
PTC549400	16 x 18"	4"	250 kg	AE04
PTC549500	17 x 17"	4"	250 kg	AE04
PTC549600	18 x 16"	4"	250 kg	AE04
PTC549700	18 x 18"	4"	250 kg	AE04
PTC549800	18 x 20"	4"	250 kg	AE04
PTC549900	19 x 18"	4"	250 kg	AE04
PTC549950	20 x 16"	4"	250 kg	AE04
PTC550000	20 x 20"	4"	250 kg	AE04

Note: This range can fit chairs from 13 x 13" to 20 x 20". Please contact Aidacare for enquiries relating to sizes outside of the displayed range. Custom made sizes are also available upon request.

### Other Ottobock Cushions



Code	Description	DVA:
PTC551000	Evolight Cushion	-
PTC550250	Terra Aquos Cushion	AE04

Note: Evolight model pictured above



For Wheelchairs  
& Positioning  
Refer to Page 271

**L** Low Risk **M** Medium Risk **H** High Risk **V** Very High Risk

#### DVA Contact Details

P 1300 888 052 | F 1300 787 052 | E [dva@aidacare.com.au](mailto:dva@aidacare.com.au)



For NDIS Item Code,  
refer to page: 508





## EquaGel - General

- Gel cushion for anyone in need of a low-profile comfortable cushion
- 12 degrees cooler than inflatable cushions which creates a more comfortable seating solution for patients
- 1.75" tall EquaGel in two stages, Gel cushion absorbs vibrations
- Comes with a fluid resistant, vapour permeable cover
- 1 Year Warranty

DVA: AE04

WIDTH (Size")	DEPTH (Size")		
	16"	18"	20"
16"	PTC551043	PTC551045	PTC551047
18"	PTC551049	PTC551051	PTC551053
20"	PTC551055	PTC551057	PTC551059
22"	PTC551061	PTC551063	PTC551065

*Note: For sizes outside of the codes displayed, please contact your Aidacare Complex Rehab. consultant. (Refer to: Complex Rehab. Overview on pg. 11)*



## EquaGel - Protector

- Gel cushion for anyone in need of a low-profile advanced comfortable cushion
- Comes with a fluid resistant, vapour permeable cover
- 12 degrees cooler than inflatable cushions which creates a more comfortable seating solution for patients
- Gel cushion absorbs vibrations
- 2.5" tall EquaGel in two stages
- 1 Year Warranty

DVA: AE04

WIDTH (Size")	DEPTH (Size")	
	16"	18"
16"	PTC551093	PTC551095
18"	PTC551096	PTC551097
20"	PTC551099	PTC551101
22"	PTC551103	PTC551105

*Note: For sizes outside of the codes displayed, please contact your Aidacare Complex Rehab. consultant. (Refer to: Complex Rehab. Overview on pg. 11)*



## Promedicare Inserto Tanto

- Foam cushion designed for those who need medium/high postural support
- Ideal for individuals with mild leg length discrepancies, wind-swept, pelvic obliquity, pelvic rotations, posterior and anterior pelvis tilt
- 13 modular and configurable inserts as standard

- Flexible open celled foam with low spring back action
- Comes with washable cover
- 2 Years Warranty (Cushion), 6 Months Warranty (Cover)

WIDTH (Size")	DEPTH (Size")			
	16"	16.5"	18"	20"
14"	-	PTC608153	-	-
16"	PTC608155	-	PTC608160	-
18"	-	-	PTC608165	PTC608170
19"	-	-	PTC608172	-

*Note: For sizes outside of the codes displayed, please contact your Aidacare Complex Rehab. consultant. (Refer to: Complex Rehab. Overview on pg. 11)*

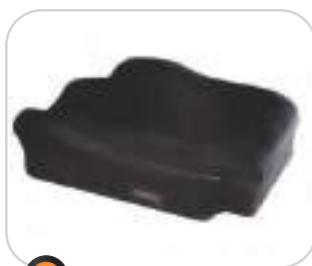

## Promedicare Inserto Domino

- Foam cushion designed for those who need higher positioning support
- Ideal for individuals with leg discrepancies, wind swept, pelvic obliquity, pelvic rotations, severe posterior/anterior pelvis tilt
- 17 modular and configurable inserts as standard

- Flexible open celled foam with low spring back action
- Comes with washable cover
- 2 Years Warranty (Cushion), 6 Months for (Cover)

WIDTH (Size")	DEPTH (Size")				
	12"	15"	16"	18"	19.5"
10"	PTC608015	-	-	-	-
12"	PTC608020	PTC608025	-	-	-
14"	-	PTC608030	-	-	-
16"	-	-	PTC608040	PTC608045	-
16.5"	-	PTC608035	-	-	PTC608036
18"	-	-	-	PTC608050	PTC608055
19"	-	-	-	PTC608056	-

*Note: For sizes outside of the codes displayed, please contact your Aidacare Complex Rehab. consultant. (Refer to: Complex Rehab. Overview on pg. 11)*





### Spex - DualTec Cushion

- Designed for those who have a mild-moderate risk of tissue breakdown
- Require simple pressure relief, and need dynamic sitting flexibility
- Lightweight and low maintenance
- High quality specific dual foam layers offer superior comfort and promote even pressure distribution while moulding to body shape
- Self-contouring 'mould and hold' to the user's pelvis



WIDTH (Size")	DEPTH (Size")							
	10"	12"	14"	16"	17"	18"	20"	22"
10"	PTC607042	PTC607043	-	-	-	-	-	-
11"	PTC607044	PTC607045	-	-	-	-	-	-
12"	-	PTC607046	PTC607047	-	-	-	-	-
13"	-	PTC607048	PTC607049	-	-	-	-	-
14"	-	-	PTC607065	PTC607066	-	-	-	-
15"	-	-	PTC607067	PTC607068	-	-	-	-
16"	-	-	-	PTC607069	-	PTC607070	-	-
17"	-	-	-	PTC607071	PTC607072	PTC607073	-	-
18"	-	-	-	-	-	PTC607074	PTC607075	-
19"	-	-	-	-	-	PTC607076	PTC607077	-
20"	-	-	-	-	-	-	PTC607078	PTC607079

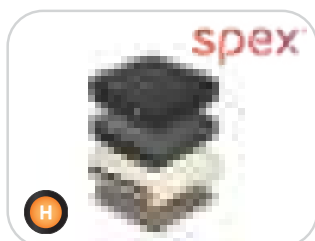

### Spex - Standard Adjustable Cushion

- Designed for the user who has moderate to severe positioning and pressure requirement
- Gel-foam ischial well evenly distributes pressure under the pelvis and reduces shear forces in sensitive areas
- Removable trochanter supports for pelvic obliquity or reduction, or build-up for hip flexion
- Includes breathable 'spacer' fabric cover and bonus inner incontinence cover.



WIDTH (Size")	DEPTH (Size")							
	10"	12"	14"	16"	17"	18"	20"	22"
10"	PTC607107	PTC607126	-	-	-	-	-	-
11"	PTC607127	PTC607128	-	-	-	-	-	-
12"	-	PTC607129	PTC607130	-	-	-	-	-
13"	-	PTC607131	PTC607132	-	-	-	-	-
14"	-	-	PTC607218	PTC607219	-	-	-	-
15"	-	-	PTC607220	PTC607221	-	-	-	-
16"	-	-	-	PTC607222	-	PTC607223	PTC607224	-
17"	-	-	-	PTC607225	PTC607226	PTC607227	-	-
18"	-	-	-	PTC607228	-	PTC607229	PTC607230	-
19"	-	-	-	-	-	PTC607231	PTC607232	-
20"	-	-	-	-	-	PTC607233	PTC607234	PTC607235

Note: For sizes outside of the codes displayed, please contact your Aidacare Complex Rehab. consultant. (Refer to: Complex Rehab. Overview on pg. 11)

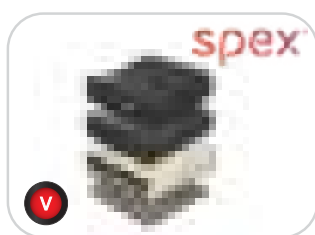

### Spex - High Adjustable Cushion

- Designed for the user who has moderate to severe positioning and pressure requirements
- Gel-foam ischial well evenly distributes pressure under the pelvis and reduces shear forces in sensitive areas
- Strategic contouring pads offer complete customisations on-the-spot for a perfect fit for the client
- Removable trochanter supports for pelvic obliquity or reduction, or build-up for hip flexion



WIDTH (Size")	DEPTH (Size")						
	10"	12"	14"	16"	17"	18"	20"
10"	PTC607093	PTC607094	-	-	-	-	-
11"	PTC607095	PTC607096	-	-	-	-	-
12"	-	PTC607097	PTC607098	-	-	-	-
13"	-	PTC607099	PTC607100	-	-	-	-
14"	-	-	PTC607186	PTC607187	-	-	-
15"	-	-	PTC607188	PTC607189	-	-	-
16"	-	-	-	PTC607190	-	PTC607191	PTC607192
17"	-	-	-	PTC607193	PTC607194	PTC607195	-
18"	-	-	-	PTC607196	-	PTC607197	PTC607198
19"	-	-	-	-	-	PTC607199	PTC607200
20"	-	-	-	-	-	PTC607201	PTC607202

Note: For sizes outside of the codes displayed, please contact your Aidacare Complex Rehab. consultant. (Refer to: Complex Rehab. Overview on pg. 11)



## Spex - Vigour Standard Contour Cushion

- Designed for the user who has symmetrical or mild asymmetrical postures needing mild to moderate postural control
- Gel-foam ischial well evenly distributes pressure under the pelvis and reduces shear forces in sensitive areas.
- Special foam layers offer anatomically correct posture
- Slight thigh elevation for increased balance
- Specific contouring offers a high degree of pelvic stability



WIDTH (Size")	DEPTH (Size")							
	10"	12"	14"	16"	17"	18"	20"	22"
10"	PTC607108	PTC607109	-	-	-	-	-	-
11"	PTC607110	PTC607111	-	-	-	-	-	-
12"	-	PTC607112	PTC607113	-	-	-	-	-
13"	-	PTC607114	PTC607115	-	-	-	-	-
14"	-	-	PTC607169	PTC607169	-	-	-	-
15"	-	-	PTC607171	PTC607172	-	-	-	-
16"	-	-	-	PTC607173	-	PTC607174	-	-
17"	-	-	-	PTC607175	PTC607176	PTC607177	-	-
18"	-	-	-	PTC607178	-	PTC607179	PTC607180	-
19"	-	-	-	-	-	PTC607181	PTC607182	-
20"	-	-	-	-	-	PTC607183	PTC607184	PTC607185

Note: For sizes outside of the codes displayed, please contact your Aidacare Complex Rehab. consultant. (Refer to: Complex Rehab. Overview on pg. 11)



## Spex - Vigour High Contour Cushion

- Designed for the user who has symmetrical or mild asymmetrical postures needing mild to moderate postural control
- Gel-foam ischial well evenly distributes pressure under the pelvis and reduces shear forces in sensitive areas.
- Special foam layers offer anatomically correct posture
- Slight thigh elevation for increased balance.
- Specific contouring offers a high degree of pelvic stability



WIDTH (Size")	DEPTH (Size")							
	10"	12"	14"	16"	17"	18"	20"	22"
10"	PTC607142	PTC607143	-	-	-	-	-	-
11"	PTC607144	PTC607145	-	-	-	-	-	-
12"	-	PTC607146	PTC607147	-	-	-	-	-
13"	-	PTC607148	PTC607149	-	-	-	-	-
14"	-	-	PTC607236	PTC607237	-	-	-	-
15"	-	-	PTC607238	PTC607239	-	-	-	-
16"	-	-	-	PTC607240	-	PTC607241	-	-
17"	-	-	-	PTC607242	PTC607243	PTC607244	-	-
18"	-	-	-	PTC607245	-	PTC607246	PTC607247	-
19"	-	-	-	-	-	PTC607248	PTC607249	-
20"	-	-	-	-	-	PTC607250	PTC607251	PTC607252

Note: For sizes outside of the codes displayed, please contact your Aidacare Complex Rehab. consultant. (Refer to: Complex Rehab. Overview on pg. 11)



### General Enquiries

P 1300 133 120 | E sales@aidacare.com.au | W www.aidacare.com.au



## Daily Living Aids

## Contents

- P 157 Dressing Aids
- P 159 Kitchen Aids
- P 161 Gripping & Turning Aids
- P 163 Cutlery
- P 165 Crockery
- P 167 Reaching Aids
- P 168 General Household & Dementia Aids



# Dressing Aids



For NDIS Item Code, refer to page: 508



## EzyAs Compression Stocking Applicator

- Unique plastic gutter to assist in pulling on compression stockings
- Stocking is fed onto gutter, held in place by side notches, slipped over foot, then pulled into place

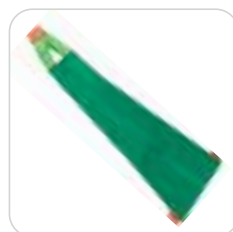

## Easy-Slide - Applicator For Open-Toe Stockings

- Application aid for open-toe stockings
- Suitable for hospital stockings with inspection hole
- Slide stocking over, and then remove through open toe

Code	Description	Calf/Arm Circ.	DVA:
DLD269001	Small - Red	280-350 mm	AU13
DLD269002	Med - Yellow	320-400 mm	AU13
DLD269003	Large - Blue	380-470 mm	AU13
DLD269004	Handle		AU13

Code	Size	DVA:
GMS340951	Small - Size 34-37	AU13
GMS340952	Medium - Size 38-41	AU13
GMS340953	Large - Size 42-45	AU13
GMS340954	X-large - Size 46+	AU13



## Compression Stocking Aid

- EUREKA-ON Plastic Fabric Slide is a compression stocking applicator for the leg or arm
- Consists of a durable paper-like slippery material with a central extended pull tab and eyelet holes on the sides for threading a thin tubular plastic lacing pin



## Leg Lifter

- Enables the user to move a stiff or immobile leg
- Upper loop fits around the hand and wrist and the lower stiffened loop slides over the foot to give control when lifting the leg

Code	Description	DVA:
DLD269010	Compression Stocking Aid - Eureka	AU13

Code	Description	DVA:
DLD269390	Leg Lifter - 864 mm	AP09



## Button Hook Kings

- Assists one handed dressing
- Shaped stainless steel wire passes through hole and over the button to grip the thread, button is then pulled through with twisting motion



## Spring Laces

- Elasticised and spring coiled shoe laces convert lace-up shoes into slip-on shoes

Code	Description	DVA:
DLD269300	Button Hook Kings	AU02

Code	Description	DVA:
DLD269140	Spring Laces - Black 600 mm	AU14
DLD269150	Spring Laces - White 600 mm	AU14
DLD269151	Spring Laces - Brown 600 mm	AU14
DLD269153	Spring Laces - Blue 600 mm	AU14

### General Enquiries

P 1300 133 120 | E sales@aidacare.com.au | W www.aidacare.com.au



### Stocking Aid - Dorking

- A simple device to assist in putting on a stocking/sock, if bending and reaching the foot is difficult
- Strong, flexible plastic gutter with long cotton tapes attached to top

Code	Description	DVA:
DLD269260	Stocking Aid - Dorking	AU13



### Stocking Aid

- Lightweight plastic gutter assists changing into and out of socks
- Sock is fed onto gutter, slipped over foot, then pulled into place

Code	Description	DVA:
DLD269275	Stocking Aid	AU13



### Terry Cloth Sock Aid

- Lightweight and comfortable heel contour assists changing into and out of socks
- Slits allow flexibility around the heel for best fit

Code	Description	DVA:
DLD269090	Terry Cloth Sock Aid	AU13



### Dressing Stick

- Lightweight wooden stick with hook assists changing into and out of garments
- Designed for those who have difficulty bending, reaching or grabbing

Code	Description	DVA:
DLD269310	Dressing Stick - 520 mm	AU04



### Notch Cord Sock Aid

- Designed to assist in reaching feet for those with restricted movement
- Notch cut out on the end hooks the sock
- The attached tapes / cord are used to pull the sock aid over the feet

Code	Description	DVA:
DLD269100	Sock Aid - Notch Cord Style	AU13



### Tights Aid

- Consists of two connected plastic contoured shapes that taper at the end, with white tapes attached to each side
- Foot portion is pulled onto the shapes whilst the user is seated

Code	Description	DVA:
DLD269280	Tights Aid	AU13



### Sock & Stocking Aid

- Designed to help those with restricted mobility
- Plastic collar/gutter holds garment at one end, and a plastic shoehorn with a notch at the other for easy sock removal
- A coated steel tube connects the two

Code	Description	DVA:
DLD269290	Sock & Stocking Aid - Brevetti	AU13



### JOBST Stocking Donner

- Application aid for closed-toe garments
- Slide stockings over, then remove from top of stocking
- Suggest to use with rubber gloves

Code	Description	DVA:
PTS641090	Small / Med - Shoe size 38	AU13



### Shoe Horn

- Long handled plastic shoe horn to assist in putting on shoes

Code	Description	DVA:
DLD269160	Shoe Horn - 430 mm	AH19



### Metal Shoe Horn

- Long handled metal shoe horn to assist in putting on shoes

Code	Description	DVA:
DLD269170	Metal Shoe Horn - 600 mm	AH19



### Compression Stocking Aid

- Applies support hosiery quickly and evenly
- Grooves catch the compression stocking and prevent it from popping off
- Suitable for Class 1 and 2 stockings

Code	Description	DVA:
DLD269110	Compression Stocking Aid - Small	AU13
DLD269120	Compression Stocking Aid - Large	AU13



# Kitchen Aids



For NDIS Item Code, refer to page: 508



## Aspire Meal Trolley



Sturdy & Robust Meal Transport Trolley



Clip on Plastic Trays with Outer Lip Edge



3" Castors with Two Locking



Tool Free Assembly



Easy Clean Frame & Food Trays



Height Adjustable in 1" Increments



1 Year Warranty

Code	Description	Overall Height	Overall Width	Overall Length	Lower Tray Height	Upper Tray Height	Tray Width	Castor Size	Unit Weight	DVA:
DLG272060	Meal Trolley	810 - 937 mm	460 mm	503 mm	351 - 478 mm	615 - 740 mm	450 mm	3"	6 kg	AH14

### General Enquiries

P 1300 133 120 | E sales@aidacare.com.au | W www.aidacare.com.au



## Good Grips Peelers

- Easy to use peelers with soft, comfortable non slip grip featuring a precision ground stainless steel blade for a sharper cutting edge

Code	Description	DVA:
DLK275100	Y Peeler	AH07
DLK275110	Swivel Peeler	AH07



## Good Grips Can Opener

- Easy to use can opener with soft, comfortable non slip grip

Code	Description	DVA:
DLK275090	Good Grips Can Opener	AH07



## Good Grips Jar Opener

- Easy to use jar opener with soft, comfortable non slip grip features stainless steel teeth allowing safe opening of any jar

Code	Description	DVA:
DLK275120	Good Grips Jar Opener	AH07



## Twister Jar Opener

- Gives a good grip for opening twist off jar lids
- Cone shaped rubber moulding with fluted finger grips on the outside and ribbing on the inside

Code	Description	DVA:
DLK275520	Twister Jar Opener	AH07



## Kitchen Workstation

- This multifunctional food preparation unit is designed to provide assistance with many day to day kitchen tasks

Code	Description	DVA:
DLK275700	Kitchen Workstation	AH15



## Bread Board Wooden

- This hardwood board is ideal for cutting one-handed, it features non-slip feet, six stainless steel spikes to grip bread or vegetables

Code	Description	DVA:
DLK275710	Bread Board Wooden - 325 x 175 mm	AH15



## Food Preparation System



- This durable cutting board is ideal for those who have difficulty in gripping, or only have the use of one hand
- Suits various food prep cutting tasks

Code	Description	DVA:
DLK275720	Food Preparation System - 315 x 295 mm	AH15



## Plastic Spread Board

- This durable one-piece board allows bread to be spread using one hand with a raised "L" shape in one corner

Code	Description	DVA:
DLK275730	Plastic Spread Board - 181 x 256 mm	AH15



## Kettle Tipper

- A raised tilting platform, designed to assist with pouring from any standard kettle with virtually no effort or risk of spilling boiling water

Code	Description	DVA:
DLK276600	Tipper - Kettle Tipper - Standard	AH17



## Moulded Lap Tray

- Durable and lightweight tray with a moulded rim and recessed area for cup or glass
- Includes two D-Ring hook and loop straps for secure attachment

Code	Description	DVA:
DLK277000	Moulded Lap Tray - 1.6 kg	



## Can Opener Pull

- The Canpull is a durable device designed for opening ring pull cans
- Hook the end under the ring, fold forwards and roll back to open

Code	Description	DVA:
DLK275610	Can Opener Pull	AH07



**For Home Modifications**  
See Page 12



# Gripping & Turning Aids



For NDIS Item Code, refer to page: 508



## Bottle Opener - One-Touch Automatic

- One-touch operated bottle opener suitable for metal or plastic screw-top bottle caps up to 55mm diameter
- Rubber jaws automatically adjust to lid

Code	Description	DVA:
DLG272310	Bottle Opener - One-Touch Automatic	AH07



## Jar Opener - One-Touch Automatic

- One-touch operated jar opener that stabilises the jar while opening the lid
- The outer jaws adjust to stabilise the side of jar, whilst inner jaws adjust to stabilise the lid during movement

Code	Description	DVA:
DLG272340	Jar Opener - One-Touch Automatic	AH07



## Can Opener - One-Touch Automatic II

- One-touch operated can opener suitable for most cans between 53mm to 153mm diameter
- Walks around the can and switches off automatically

Code	Description	DVA:
DLG272330	Can Opener - One-Touch Automatic II	AH07



## Multi Purpose Holder

- Comfortable, easily adjustable, strap handle that provides a secure grasp on a variety of handle shapes and sizes

Code	Description	DVA:
DLK276430	Multi Purpose Holder	AH06



## Gordon Peeler

- A rigid metal vegetable peeler which is clamped on to the side of a bench to allow user to peel vegetables with one hand

Code	Description	DVA:
DLK275630	Peeler - Gordon	AH01



## Tap Turner - Contour

- This device is used to give good leverage for turning small difficult items e.g. gas or radiator taps

Code	Description	DVA:
DLG271300	Tap Turner - Contour	AH13



## Tap Turner Crystal

- Provides leverage to assist turning taps
- Clamps onto cylindrical taps up to 6cm in diameter

Code	Description	DVA:
DLG271290	Tap Turner Crystal (Ea)	AH13



## Tap Turners

- Moulded plastic turner fits over the X shaped tap head
- Supplied as 1 red and 1 blue to be used with hot and cold taps

Code	Description	DVA:
DLG271280	Tap Turners (Pair) - 140 mm	AH13

### General Enquiries

P 1300 133 120 | E sales@aidacare.com.au | W www.aidacare.com.au



## Undo-it Jar Opener

- V-shaped coated metal opener that is screwed underneath a shelf or cupboard
- Jar is slid into V until the lid wedges. It is then twisted to remove the lid. Suitable for tops 25 to 75mm (1 to 3") diameter

Code	Description	DVA:
DLK275530	Undo-it Jar Opener	AH07



## Bottle Holder - Belliclamp

- Hooks over edge of worktop and the jar/bottle is then placed in the V
- Object is clamped by the ram, which can be pushed with the stomach or hip, leaving hands free to twist the top

Code	Description	DVA:
DLK275580	Bottle Holder - Belliclamp	AH07



## Strongboy Opener

- Assists in opening a variety of twist off jar lids
- Flexible stainless steel band is fitted around a lid, and then clamped using the screw at the end of the handle

Code	Description	DVA:
DLK275550	Strongboy Opener	AH07



## Key Turner

- Heavy duty Key Turner provides a curved handle for comfortable grip and increases leverage
- Key Turner 2 - Blue model holds two keys

Code	Description	DVA:
DLG271310	Key Turner - White	AH08
DLG271320	Key Turner 2 - Blue	AH08



## Can Opener - Electric Kenwood w/ Bottle Opener

- Electric can/bottle opener and knife sharpener. Automatic start/stop function
- A retaining magnet, grey slip resistant handle and slip resistant base secures the can in place

Code	Description	DVA:
DLG272350	Can Opener - Electric Kenwood with Bottle Opener	AH07



## Uno Grips Red/Blue

- Uno Grips are soft covers that enable you to grip and twist door knobs or round faucets with less effort

Code	Description	DVA:
DLG271100	Uno Grips - Clear	AH13
DLG271110	Uno Grips - Semi Clear	AH13
DLG271120	Uno Grips - Red/Blue (hot & cold taps)	AH13



## Dycem Anchor Pad

- This product is made out of Dycem, an effective non-slip material

Code	Description	DVA:
DLG271380	Dycem Anchor Pad - Round - 190 mm	AH09
DLG271390	Dycem Anchor Pad - Small - 250 x 180 mm	AH09
DLG271400	Dycem Anchor Pad - Large - 350 x 250 mm	AH09
DLG271410	Dycem Anchor Activity Anchorpad - 450 x 380 mm	AH09



## Pen Holder

- Designed for easier grip and control, made from soft PVC it slides over normal sized pens and pencils
- Sold as a set of three

Code	Description
DLG271520	Pen Holder



## Grippimat Reel

- Grippimats are thinner and more flexible than the moulded ones, therefore they can be wrapped around items e.g. jar tops

Code	Description	DVA:
DLG271440	Grippimat Reel - White - 200 mm x 2 m	AH09
DLG271450	Grippimat Reel - Blue - 200 mm x 2 m	AH09
DLG271460	Grippimat Reel - Blue - 200 mm x 9 m	-
DLG271470	Grippimat Reel - White - 400 mm x 2 m	AH09
DLG271480	Grippimat Reel - Blue - 400 mm x 2 m	AH09
DLG271490	Grippimat Reel - Blue - 400 mm x 9 m	-



## Foam Utensil Handles

- Built-up handle for easier gripping. 1 meter in length, internal/external diameters range - listed below

Code	Description	DVA:
DLG271270	FoamTube - Grey - 31 mm Ext, 12 mm Int	AH17
DLG271230	FoamTube - Grey - 31 mm Ext, 6 mm Int	AH17
DLG271250	FoamTube - Grey - 31 mm Ext, 9 mm Int	AH17
DLG271260	FoamTube - White - 31 mm Ext, 12 mm Int	AH17
DLG271210	FoamTube - White - 19 mm Ext, 6 mm Int	AH17
DLG271220	FoamTube - White - 31 mm Ext, 6 mm Int	AH17

# Cutlery



For NDIS Item Code, refer to page: 508



## Supergrip Cutlery

- Comfortable, wide, built-up ribbed handled utensil set. Stainless steel, dishwasher safe
- Handles are 102mm long, 38mm wide

Code	Description	DVA:
DLK275310	Supergrip Teaspoon	AH01
DLK275320	Supergrip Tablespoon	AH01
DLK275330	Supergrip Fork	AH01
DLK275340	Supergrip Knife	AH01



## Supergrip Bendable Cutlery

- Bent into any angle, for reduced range of motion. Stainless steel, dishwasher safe
- Handles are 102mm long, 31mm wide

Code	Description	DVA:
DLK275360	Supergrip Bendable Teaspoon	AH01
DLK275370	Supergrip Bendable Tablespoon	AH01
DLK275380	Supergrip Bendable Fork	AH01
DLK275390	Supergrip Bendable Knife	AH01



## Softouch Cutlery

- Plastic coated spoons provide protection for teeth/lips from edges and temperature sensitivity. Not recommended for those with heavy biting reflexes

Code	Description	DVA:
DLK275410	Softouch Teaspoon	AH01
DLK275430	Softouch Youth Spoon	AH01



## Queens Splayed Cutlery

- The Fork has an edge for cutting, and the steel blade knife has pronged end that acts as a fork, to allow for one hand eating
- Handles are 98mm long, 30mm wide

Code	Description	DVA:
DLK275800	Queens Splayed Fork	AH01
DLK275810	Queens Nelson Knife	AH01



## Queens Cutlery

- Stainless steel utensils mounted into a built-up plastic grip handle. The items are hygienically sealed, and are dishwasher safe
- Handles are 98mm long, 30mm wide

Code	Description	DVA:
DLK275760	Queens Cutlery Knife	AH01
DLK275770	Queens Cutlery Fork	AH01
DLK275780	Queens Cutlery Dessert Spoon	AH01
DLK275790	Queens Cutlery Junior Spoon	AH01
DLK275870	Queens Cutlery Set	AH01



## Queens Angled Cutlery

- Stainless steel utensil range with an angled head, enabling those with limited wrist movement to eat more easily. Fork and spoon available in left or right
- Handles are 98mm long, 30mm wide

Code	Description	DVA:
DLK275820	Queens Angled Knife	AH01
DLK275830	Queens LH Angled Fork	AH01
DLK275840	Queens RH Angled Fork	AH01
DLK275850	Queens LH Angled Spoon	AH01
DLK275860	Queens RH Angled Spoon	AH01



## Caring Cutlery

- Contoured stainless steel with plastic handles and built-up ends. Hygienically sealed, dishwasher safe.

Code	Description	DVA:
DLK276300	Caring Knife - 127 mm handle	AH01
DLK276310	Caring Fork - 127 mm handle	AH01
DLK276320	Caring Spoon - 127 mm handle	AH01



## Nelson Knife

- Stainless steel and dishwasher safe knife, designed for one handed eating, pronged end used as a fork. Built up sleeve from the Kings Modular cutlery range may be added to the handle

Code	Description	DVA:
DLK276440	Nelson Knife	AH01



### Reflex Cutlery

- Grip contoured handles, blades set at an angle from the handle to minimise wrist movement. Dishwasher safe

Code	Description	DVA:
DLK275650	Reflex Preparation Knife - 127 mm Blade	AH17
DLK275660	Reflex Carving Knife - 203 mm Blade	AH17
DLK275670	Reflex Chef Knife - 203 mm Blade	AH17
DLK275680	Reflex Slicing Knife - 254 mm Blade	AH17



### Kings Built Up Sleeves

- Contoured PVC sleeves fit Kings Slim Handle
- The oval is oval in shape whilst the small and large are contoured with finger grips
- They provide a larger grip for the user

Code	Description	DVA:
DLK276140	Kings Oval Built Up Sleeve - 23-30 mm wide	AH06
DLK276150	Kings Small Built Up Sleeve - 22 mm wide	AH06
DLK276160	Kings Large Built Up Sleeve - 29-35 mm wide	AH06



### Kings Modular Cutlery

- The Kings Modular Cutlery is mounted in a plastic spigot that pushes tightly into your chosen handle, but allow the blade to be angled as desired

Code	Description	DVA:
DLK275900	Kings Knife - Std Head - 112 mm Handle	AH01
DLK275910	Kings Fork - Std Head - 104 mm Handle	AH01

Code	Description	DVA:
DLK275970	Kings Nelson Knife - Std Head Handle	AH01
DLK276040	Kings Rocker Knife - Large Std Head	AH01
DLK275980	Kings Rocker Knife - Small Std Head	AH01
DLK275960	Kings Splayed Kit (Knife, Fork, Spoon)	AH01
DLK275930	Kings Junior Spoon - 91 mm Handle	AH01
DLK275920	Kings Spoon - Std Head - 104 mm Handle	AH01
DLK275940	Kings Teaspoon - 84 mm Handle	AH01
DLK275950	Kings Soup Spoon - 112 mm Handle	AH01



### Kings Handles

- Compatible with Kings Modular/Angled ranges
- Standard - hollow cylindrical body. Slim - oval cross-section. Contoured - curved shape and finger contours. Heavy - handle's core is a non-toxic metal bar for a heavier handle, is ideal for those with tremors

Code	Description	DVA:
DLK276070	Kings Standard Handle - 25 mm wide	AH06
DLK276060	Kings Contour Handle - 22-30 mm wide	AH06
DLK276100	Kings Heavy Handle - 25 mm wide	AH06
DLK276120	Kings Slim Handle - 14-19 mm wide	AH06



### Kings Angled Cutlery

- Hygienic, non corroding and dishwasher safe. Each is mounted with a plastic spigot that fits tightly into the chosen handle
- Handles are 98mm long

Code	Description	DVA:
DLK276010	Cutlery - Kings - Fork - Angled Fork Right Hand	AH01
DLK276020	Cutlery - Kings - Spoon - Angled Spoon Left Hand	AH01
DLK276030	Cutlery - Kings - Spoon - Angled Spoon Right Hand	AH01
DLK276050	Cutlery - Kings - Angled Adaptor (PKT3)	AH06
DLK276000	Cutlery - Kings - Fork - Angled Fork Left Hand	AH01
DLK275990	Cutlery - Kings - Knife - Angled Knife	AH01



### Kings Lightweight Handles

- Sculptured closed-cell foam handles are waterproof, washable and feature contoured finger grips

Code	Description	DVA:
DLK276090	Kings Lightweight Handle - Small - 20 mm wide	AH06
DLK276080	Kings Lightweight Handle - Large - 28 mm wide	AH06



### Kings Softcoated Head Spoon

- Range is coated in soft, food quality white PVC making the spoons ideal for users with a bite reflex problem when eating

Code	Description	DVA:
DLK275880	Kings Spoon Softcoated Head - 100 mm Handle	AH01
DLK275890	Kings Teaspoon Softcoated Head - 80 mm Handle	AH01



### Kings Mushroom Handle

- Round hollow doorknob type handle which is easy to grip for those with weak or painful joints

Code	Description	DVA:
DLK276130	Kings Mushroom Handle	AH06



### Kings Assessment Set

- Includes all 18 of the Kings modular utensils, variety of handles and a sleeve to build up a handle further, total of 32 pieces

Code	Description
DLK276170	Kings Assessment Set



### Lightweight Cutlery

- Stainless steel utensils are mounted on plastic stems and sealed into washable grey foam handles, for those with weak/painful grip

Code	Description	DVA:
DLK276220	Lightweight Cutlery Set - 3 piece - 115 mm handle	AH01
DLK276200	Lightweight Spoon - 115 mm handle	AH01
DLK276190	Lightweight Fork - 115 mm handle	AH01
DLK276180	Lightweight Knife - 115 mm handle	AH01
DLK276210	Lightweight Teaspoon - 115 mm handle	AH01



### Lightweight Angled Cutlery

- Stainless steel with closed cell foam handles. Knife blade at 90° angle. Fork/spoon at 40° angles and are available as left/right handed versions

Code	Description	DVA:
DLK276240	Lightweight Angled Fork LH - 115 mm handle	AH01
DLK276250	Lightweight Angled Fork RH - 115 mm handle	AH01
DLK276230	Lightweight Angled Knife - 115 mm handle	AH01
DLK276260	Lightweight Angled Spoon LH - 115 mm handle	AH01
DLK276270	Lightweight Angled Spoon RH - 115 mm handle	AH01

# Crockery



For NDIS Item Code, refer to page: 508



## Anti Spill Mug

- Tough, clear plastic mug with a large handle. Mug is dishwasher and microwave safe. Lid is not.
- Supplied with two lids, one for anti-spill, and one with drinking spout

Code	Description	DVA:
DLK276500	Anti Spill Mug - 400 ml	AH01



## Caring Mug

- Wide stable base with two large contoured and angled handles. Microwave safe
- Designed to be held in a comfortable position for drinking, useful for people with tremor or who cannot sit upright

Code	Description	DVA:
DLK276510	Caring Mug - 300 ml	AH01



## Dysphagia Cup

- Designed to assist people who have trouble swallowing
- Helps prevent liquids from escaping at the lips and directs the liquid to the centre of the mouth

Code	Description	DVA:
DLK275470	Dysphagia Cup - Green - 200 ml	AH17
DLK275460	Dysphagia Cup - Almond - 200 ml	AH17



## Feeding Cup Adjustable Spout

- A feeding cup with a spout that can be vertical or clicked over to an angled position for drinking when less tilt is required. Sold in pairs

Code	Description	DVA:
DLK276570	Feeding Cup with adj. 4mm spout - 400 ml	AH01
DLK276580	Feeding Cup with adj. 8mm spout - 400 ml	AH01



## Two Handled Mug

- Designed to make drinking safer and easier for people with hand tremors
- Supplied with two lids, one for anti-spill and one with a drinking spout and two handles to assist with control

Code	Description	DVA:
DLK276520	Two Handled Mug - 200 ml	AH01



## Inner Lip Plate

- Plate with an inner lip to hold food on plate while user scoops against it
- Polycarbonate sandstone colour, not for use with serrated knives, dishwasher and microwave safe up to 80°C

Code	Description	DVA:
DLK275290	Inner Lip Plate - 228 mm	AH01



## Incurve Plate Surround

- Three clips attach it to the rim of a dinner plate to assist with one-handed eating and prevent spillage
- Fits a large range of plate sizes, flexible nylon construction, microwave and dishwasher safe

Code	Description	DVA:
DLK276490	Incurve Plate Surround - 190 - 254 mm	AH01



## Medici Plate

- A deep dished plate to assist with picking up food. Made from scratch-resistant plastic
- The large contoured rim makes the plate easier to grip. It is lightweight, stackable, and dishwasher safe

Code	Description	DVA:
DLK276480	Medici Plate - 241 mm	AH01

### General Enquiries

P 1300 133 120 | E sales@aidacare.com.au | W www.aidacare.com.au



### Feeding Cup

- A clear plastic beaker, designed for easy gripping, which has a vented lid with a drinking spout
- Available with 4mm or 8mm spout hole
- Sold in pairs

Code	Description	DVA:
DLK276550	Feeding Cup with 4 mm spout - 200 ml	AH01
DLK276560	Feeding Cup with 8 mm spout - 200 ml	AH01



### Manoy Plate

- Melamine oval shaped plate helps those with one good hand or who have difficulty picking up food with utensils
- Sloping bottom and high sided end to help scoop up food without spilling it over the side
- Not suitable for microwave ovens, but dishwasher safe

Code	Description	DVA:
DLK276450	Manoy Plate - Small - 227 x 159 mm	AH01
DLK276460	Manoy Plate - Large - 279 x 159 mm	AH01



### Plate Guard

- Attaches to dinner plate to assist with one-handed eating and prevent spillage
- High temp plastic ring snaps around plate, fits a large range of plate sizes
- Crystal clear plastic is easy to keep clean
- Dishwasher safe to 50°C, latex free, not suitable for microwave

Code	Description	DVA:
DLK275450	Plate Guard - Large - 220 - 250 mm	AH01



### Economy Scoop Dish

- Plate with a high curved lip to scoop food against
- Assists those with one good hand or who have difficulty picking up food with utensils
- Non slip rubber coated base to prevent sliding
- Washes in top shelf of domestic dishwashers, not recommended for microwave use

Code	Description	DVA:
DLK275300	Economy Scoop Dish - 200 ml	AH01



### Nosey Cup

- These cups are designed for added comfort and convenience
- A special cutout helps to maintain the proper head and neck positioning when swallowing, making drinking even easier

Code	Description	DVA:
DLK275480	Nosey Cup 115 - BlueTint - 115 ml	AH01
DLK275490	Nosey Cup 225 - BlueTint - 225 ml	AH01
DLK275500	Nosey Cup 340 - BlueTint - 340 ml	AH01
DLK275510	Nosey Cup - White - 225 ml	AH01

### Also available:

- 1 Meal Tray Walker  
See Page 259
- 2 Meal Trolley  
See Page 261
- 3 Indoor Walker  
See Page 261

1



2



3



# Reaching Aids



For NDIS Item Code, refer to page: 508



## Pick Up Reacher

- Unique lightweight, robust and wear resistant reacher, ideal for use on a wide variety of items
- Twin gripping jaws and a magnetic head ideal for easy retrieval of small items
- Rotatable head, removable stick clip allows attachment to walking aids

Code	Description	DVA:
DLR279220	Pick Up - 340 mm	AH11
DLR279150	Pick Up - 600 mm	AH11
DLR279170	Pick Up - 750 mm	AH11
DLR279230	Pick Up - 900 mm	AH11
DLR279180	Pick Up - 750 mm + Lock & Forearm Support	-



## Pick Up Reacher

- The Easireach 2 Reacher is a lightweight aluminum reacher with a comfortable ergonomic handle, designed for people with limited reach or strength
- The 3 jaw opening with orange slip-resistant surface gives high visibility and a secure hold on

Code	Description	DVA:
DLR279040	Easireach 2 - 380 mm	AH11
DLR279050	Easireach 2 - 530 mm	AH11
DLR279060	Easireach 2 - 660 mm	AH11
DLR279070	Easireach 2 - 810 mm	AH11
DLR279080	Easireach 2 - Folding Short - 660 mm	AH11
DLR279090	Easireach 2 - Folding Long - 810 mm	AH11



## Reacher Economy

- Ergonomic and slip-resistant handle to reduce strain and provide secure grip
- Robust construction with elliptical matte finish shaft that reduces risk of slipping when using the second hand for support
- It features slip resistant ridged jaws and an adjustable rotating jaw head

Code	Description	DVA:
DLR279240	RevoReach Select - Standard - 660 mm	AH11
DLR279243	RevoReach Xcel - Long - 810 mm	AH11

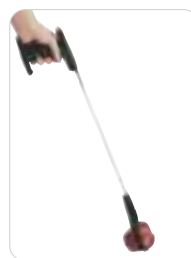

## Handireacher

- An ultra lightweight, robust reacher
- Single moving jaw, rotates 360° to avoid the need to rotate the wrist
- The head has a magnet for picking up small metal objects
- The trigger, operated by four fingers instead of the usual two is easy to grip and operate

Code	Description	DVA:
DLR279110	Handireacher - 610 mm	AH11
DLR279120	Handireacher - 760 mm	AH11
DLR279130	Handireacher - 890 mm	AH11



## Reacher Economy

- Hook trigger, easy closing jaw
- Trigger enables reacher to hang on a walker or chair. Slip resistant jaw surface provides a secure hold

Code	Description	DVA:
DLR279010	Reacher Economy - 660 mm	AH11
DLR279020	Reacher Economy - 838 mm	AH11



# General Household & Dementia Aids



For NDIS Item Code, refer to page: 508



## Vehicle Handy Bar

- The Handy Bar inserts into the U-shaped striker plate on your vehicle door frame to help support getting out of the car

Code	Description	DVA:
DLG271670	Handy Bar - 230 mm	AP09



## AutoAssist Grab Bar

- The AutoAssist Grab Bar acts as a support for when entering and exiting out of the car. The AutoAssist fits most latches and runs parallel to the door.

Code	Description
DLG271671	AutoAssist Grab Bar



## Easigrip Scissors

- Easigrip Scissors are extremely lightweight
- Handle automatically reopens the scissors when pressure is released

Code	Description	DVA:
DLG271330	Easigrip Scissors Round - 45 mm	AH12
DLG271340	Easigrip Scissors Pointed - 45 mm	AH12
DLG271350	Easigrip Scissors Pointed - Long - 75 mm	AH12



## Denture Brush with Suction Cup

- Suction brush to clean dentures & nails

Code	Description	DVA:
DLG271190	Denture Brush w/ Suction Cup	AU03



## Easigrip Chiropodist Scissors

- The long loop handles allow the whole hand to be used for control, ideal for those with a weak grip. Overall length of 200mm, and blade length of 30 mm

Code	Description	DVA:
DLG271360	Easigrip Chiropodist Scissors	AH12



## Denture Box

- Denture Box designed for bedside storage, complete with a lid
- Autoclavable for easy sanitising

Code	Description	DVA:
DLG271060	Denture Box	AU03
WAT770800	Denture Cup 250 ml (without lid)	AU03
WAT770850	Denture Cup Lid	AU03



## Book Stand

- Lightweight and stable stand holds books or magazines up and open
- Ideal as an aid for cooking or typing
- Folds flat for storage

Code	Description	DVA:
DLG271560	Book Stand - 305 x 229 mm	AH04



## SOS Safety Alert Bracelet

- Medical information locket worn as jewellery

Code	Description	DVA:
DLG271950	Safety Alert Bracelet - SOS Ladies	AS16
DLG271951	Safety Alert Bracelet - SOS Mens	AS16
GMS336150	Safety Alert Bracelet - Blank to Engrave	AS16

### DVA Contact Details

P 1300 888 052 | F 1300 787 052 | E [dva@aidacare.com.au](mailto:dva@aidacare.com.au)



For NDIS Item Code, refer to page: 508







### Long Handled Dustpan & Brush

- Plastic dustpan and soft bristled brush have long stems and plastic handles. Designed to reduce bending down to sweep up. The brush clips on to the dustpan stem for storage

Code	Description
DLG271500	Long Handled Dustpan & Brush - 970 mm



### Dementia Care Glowing Sheet

- Visible for 8-10 hours after 20 minutes of exposure to an adequate light source
- Can be cut into all of shapes and patterns applied to clean and dry surface
- Indoor durability is in excess of 5 years

Code	Description	DVA:
DCO100135	Glowing A4 Vinyl Sheet w/Adhesive Back	BF02
DCO100140	Glowing A3 Vinyl Sheet w/Adhesive Back	BF02



### Glow In The Dark Toilet Seat

- The Glow in the Dark Toilet Seats offer up to 12 hours glow time after 20 minutes exposure to adequate light source
- Appears a whitish colour in light and emits a soft, warm, blue glow at night.
- Safe, strong and durable

Code	Description	Warranty	DVA:
DCO100150	Glow in the Dark Toilet Seat w/Lid	1 Year	BF03

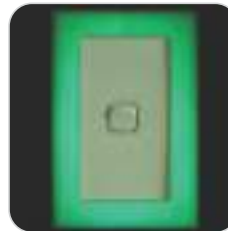

### Glowing Surround for Lightswitch

- Plastic frame glows green in the dark, and is designed to stick (using adhesive) over the surrounds of an existing wall mounted light switch or power point
- The glow recharges using natural or artificial light
- Will glow for up to 12 hours

Code	Description	DVA:
DCO100115	Glowing Surround for Lightswitch - Standard	BF02
DCO100120	Glowing Surround for Lightswitch - Slimline	BF02



### Dementia Care Wooden Toilet Seat

- Uses colour contrast to assist those to have visual perception difficulties
- Hinges can be fixed from either the top or bottom of the pan
- Fits most toilets

Code	Description	DVA:
DCO100145	Wooden Toilet Seat w/Lid - Blue	BF03



### Dementia Care Glow Tape

- Luminescence substance which is visible for more than 100 hours
- Charged from overhead and natural lighting
- Suitable for adhesion to smooth, hard, non-porous

Code	Description	DVA:
DCO100125	Glow Tape - 25mm x 10m Roll	BF02
DCO100130	Glow Tape - 50mm x 10m Roll	BF02



### Orientation Signs

- Suitable for people with dementia who are becoming disorientated to place
- Signage should be placed at eye height and preferably on the door it relates to
- Adhesive back
- 300mm Length and 200mm Width

Code	Description	Warranty	DVA:
DCS100105	Orientation Signs - Bathroom	1 Year	BF02
DCS100120	Orientation Signs - Bedroom	1 Year	BF02
DCS100135	Orientation Signs - Bedroom w/Name	1 Year	BF02
DCS100150	Orientation Signs - Dining Room	1 Year	BF02
DCS100165	Orientation Signs - Garden	1 Year	BF02
DCS100180	Orientation Signs - Kitchen	1 Year	BF02
DCS100195	Orientation Signs - Laundry	1 Year	BF02
DCS100210	Orientation Signs - Stop (300 x 300 mm)	1 Year	BF02
DCS100225	Orientation Signs - Telephone	1 Year	BF02
DCS100240	Orientation Signs - Toilet	1 Year	BF02
DCS100255	Orientation Signs - TV Room	1 Year	BF02
DCS100270	Orientation Signs - Wardrobe	1 Year	BF02

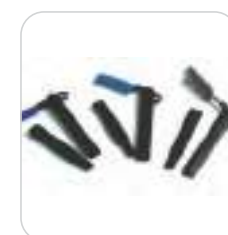

### Long Handled Comb/Brush

- Comb or brush with long handle attached, designed for those having difficulty raising, bending or reaching with their arms
- Lightweight moulded plastic handle with a push-on extension piece that is easily removed

Code	Description	DVA:
DLD269340	Long Handled Comb - 460 mm ( 235 mm folded)	AU08
DLD269350	Long Handled Brush - 460 mm ( 235 mm folded)	AU08



### Etac Hair Washer

- Long handled washer to assist hair washing

Code	Description	Warranty	DVA:
DLG272301	Hair Washer - Etac	1 Year	AU08



### Room Motion Monitor

- The Room Motion Monitor has a 3 year warranty, night light, talk back, sound sensitive light display, paging function, variable mute function, fully adjustable digital volume control, out of range/low battery warning, charging cradle included, rechargeable batteries included & in-use time up to 20 hours

Code	Description	DVA:
DCO100155	Room Motion Monitor - Oricom Secure 520	BF08



### Doorbell Alarm

- Sound is accompanied by several bright flashes from the receiver's built in strobe light, which makes it much easier for a hearing impaired person to know that someone is at the door
- Can be taken from room to room, or even used outdoors and will work up to 30 metres from the transmitter button

Code	Description	DVA:
DLG272100	Doorbell - High Vol Wireless w/ Strobe and Lanyard (4x C-Cell Batteries - not incl)	AL21



### Touch Lamp Light

- Square touch lamp with a brushed chrome base and matte opal glass diffuser
- LED and CFL compatible, touch on/off
- Modern look matte opal glass, 1.8m cord
- Recommended Globe type: B22

Code	Description	DVA:
DLG272227	Lighting - Touch Lamp - 110 x 110 x 275 mm	BG03



### Retractable Garden Hose

- 20m Retractable Hose Reel with Spray Gun has a unique lid which allows you to look inside the reel & inspect the hose
- Retractable hose reel easily mounts to a wall or fence using the heavy duty bracket

Code	Description	DVA:
DLG272240	Retractable Garden Hose - 20mm x 20m	-
DLG272241	Retractable Garden Hose - 30m Lithium-ion	BG04
DLG272242	Auto Wind Hose Reel - Pope 12mm x 20m	BG04
DLG272243	Auto Wind Hose Reel - Pope 12mm x 30m	BG04



### Beon Sensor Light

- Install indoors or outdoors
- Fully adjustable
- Up to 15 metre range on the eye, can be reduced to a few inches by adjusting the eye
- Adjust left or right
- Adjustable timing settings from a few seconds to 15 minutes

Code	Description	DVA:
DLG272230	Sensor Adapter (Globe Excluded) with fixing adaptor	BG03

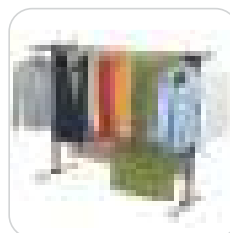

### EcoDry Clothes Line

- Height Adjustability – It can be easily changed from 95cm to 142 cm, with 16 lines of drying space
- Line Tensioning System – Eliminates line sagging, with a twist of a lever
- Hidden Wheels – Makes moving easier



Code	Description	DVA:
DLG272257	EcoDry Clothes Line	BG05



### Outdoor Sensor Light

- Sensing angle up to 120 degrees and range up to 12m
- Sensor can be pointed in the direction required. Manual override - light can be switched to stay on
- Selectable Motion Timer: 1, 5, or 10 minutes



Code	Description	DVA:
DLG272215	Lighting - Outdoor Sensor Light	BG02

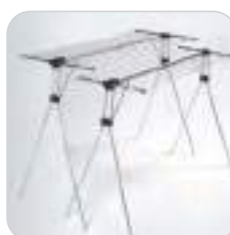

### Mrs Peggs Handy Line

- Light and ultra-strong clothes drying rack that can be left outside or folded for easy storage
- Available in a Deluxe Stainless Steel model (pictured) and a Standard Powder Coated model

Code	Description	DVA:
DLG272255S	Standard Handy Line - Small - 1630 x 610 mm	BG05
DLG272255L	Standard Handy Line - Large - 1730 x 760 mm	BG05
DLG272256S	Deluxe Handy Line - Small - 1630 x 610 mm	-
DLG272256L	Deluxe Handy Line - Large - 1730 x 760 mm	-



### Pressure Activated Mat and Alarm

- Slide the pressure sensitive pad under your door mat to be notified if someone steps on it
- Battery operated and supplied with a mounting bracket

Code	Description	DVA:
DCO100270	Pressure Activated Mat and Alarm	BF09



### Tabtimer Automated Pill Dispenser

- 28 Pill compartment design
- Up-to 6 alarms per day.
- Can be preloaded for 7 to 28 days
- Lockable pill dispenser, ensures only the right dose is accessible

Code	Description	DVA:
DCO100175	Carousel Automated Pill Dispenser with clear lid	BF06



### Pill Box Reminder

- Up-to 4 alarms per day
- 3 compartments for storing different medications
- 24 hour clock, LCD display
- 1x LR44 size battery included
- Unit Dimensions: 120 x 45 x 23mm

Code	Description	DVA:
DCO100190	Pill Box Reminder	BF06



### Reminding Clock

- Up to 4 alarms per day - square reminder
- Alarms sound 3 times then every minute until confirmed
- 12 hour clock with LCD display
- 2x AAA size batteries included
- Unit Dimensions: 69 x 49 x 15mm

Code	Description	DVA:
DCO100195	Tabtimer Automated Pill Dispenser	BF01



### Easy-to-Read Alarm Clock

- Displays in non-abbreviated words the day of the week, time and date in large text up to 190mm high
- Useful tool for people living with memory impairment

Code	Description	DVA:
DCO100205	Easy-to-read Alarm Clock	BF01



### Talking Alarm Clock Kit with AC Adaptor

- Record up to 6 custom alarm messages
- Alarm Sounds Periodically until the red button is pressed
- Integrated Dual Speakers ensure the alarm is always heard
- Large-Type LCD Display with Light
- Batteries included

Code	Description	DVA:
DCO100200K	Talking Alarm Clock with AC Adaptor Kit	BF01



### Automatic Calendar Clock

- It features a reliable German movement and an automatic calendar function that self-adjusts for leap years
- This is an ideal clock wherever people are completing forms and need a reminder of the day of the week

Code	Description	Warranty	DVA:
DCT100105	Automatic Calendar Clock	1Year	BF01

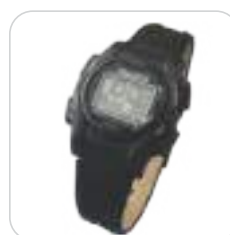

### Reminder Watch

- Never forget to take your medications again with this outstanding vibrating watch
- Smaller watch body case, easy to read time digits, attractive Styling, water resistant, automatic Leap Year Handling

Code	Description	DVA:
DCO100210	Reminder Watch	BF01



### Calendar Clock

- The 300mm clock face and easy-to-read day and date calendar can be easily read up to 15 meters away
- The clock includes a reliable German movement and an automatic calendar function that self-adjusts for leap years

Code	Description	Warranty	DVA:
DCT100110	Calendar Clock	1Year	BF01

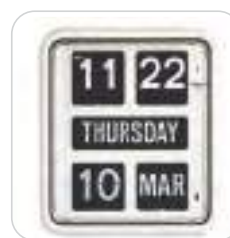

### Day of the Week Calendar Clock

- The 12 hour format has an AM/PM indicator and the day of the week is spelt out in full
- Large calendar clock is easily read from 20 meters and the clean design is ideal in both home and business interiors

Code	Description	Warranty	DVA:
DCT100100	Day of the Week Calendar Clock	1Year	BF01



### Power Point Plug Protectors

- Outlet Plug Protectors designed to prevent electrical shock
- Each durable plastic plug fits into any standard Australian outlet, preventing people from putting fingers or small objects into the socket

Code	Description	DVA:
DCO100245	Power Point Plug Protectors	BF11



### Fridge Lock

- Prevent your child from getting into the refrigerator with the Perma Child
- Safety easy to use refrigerator lock. Removes cleanly leaving no marks or surface damage
- Easy self adhesive installation

Code	Description	DVA:
DCO100220	Fridge Lock	BF11



### Cupboard C-Lock

- Solution to keep your little ones out of cupboards and drawers. Simple click into place and lock to stop access
- Easy installation
- Light weight plastic to prevent injury

Code	Description	DVA:
DCO100225	Cupboard C-Lock	BF11



### Oven or Microwave Lock

- Silver Range Microwave and Oven Locks are suitable for most ovens, microwave ovens, dishwashers, washing machines and clothes driers
- Strong and durable construction, heat-resistant adhesive, easy to install

Code	Description	DVA:
DCO100230	Oven or Microwave Lock	BF11



### Cabinet Corner Lock

- Helps keep children safe from harm and are suitable for corner drawers, cabinets, appliances and laundry cabinets

Code	Description	DVA:
DCO100215	Cabinet Corner Lock	BF11

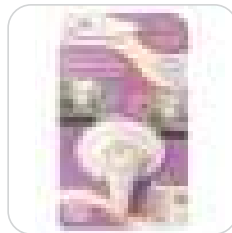

### Stove Knob Safety Locking Cover

- Swivel Appliance Latches with heat-resistant adhesive
- Colour indicator shows if the lock is
- Strong and durable construction
- Easy to install

Code	Description	DVA:
DCO100240	Stove Knob Safety Locking Cover	BF11



### Magnetic Cupboard Lock

- Hidden inside cupboards and drawers, it is the ultimate child safety product
- Automatically locks when closed, but convenient disengaging clip means door can remain unlocked when necessary
- Not visible from the outside
- One key opens all the locks in the pack

Code	Description	DVA:
DCO100250	Magnetic Cupboard Lock	BF11



### Internal Cupboard Lock

- Prevent your child from getting into cupboards with our effective and easy to use Safety Catch
- Comes in a pack of 6
- Easy self adhesive installation
- White in colour

Code	Description	DVA:
DCO100235	Internal Cupboard Lock	BF11



CONTACT US  
FOR A BROCHURE



# aidacare

HEALTHCARE EQUIPMENT

## Preventative Maintenance Program



# Laundry, Cleaning & Kitchen

# Contents

- P 175 Linen Skips
- P 178 Clean Linen & Storage
- P 180 Other Trolleys
- P 182 Kitchen Trolleys



# Linen Skips



## Linen Skip (No Lid) - Stainless Steel (Hygiene)



- All stainless steel construction
- All joints fully welded - assists with infection control
- Heavy duty grey rubber castors - 100mm swivel
- Uprights are fixed at rear for swift bag removal

	Code	Description	Length	Width	Height	Warranty
1	LAC500800	Linen Skip - Stainless Steel - Single	430 mm	430 mm	940 mm	5 Years
2	LAC500810	Linen Skip - Stainless Steel - Double	430 mm	860 mm	940 mm	5 Years
3	LAC500820	Linen Skip - Stainless Steel - Triple	430 mm	1280 mm	940 mm	5 Years
4	LAC500920	Soiled Linen Skip Bag Support - Stainless Steel (For Half Sized 10 kg Bag) - Clip on (sold separately as singles)				
	LAC500925	Soiled Linen Skip Push Handle - Single - Stainless Steel				
5	LAC500930	Buffer Disc and Reducing Bush to Suit Linen Skips (Each)				
6	LAC500926	Waste Bin - Stainless Steel Frame (Clip on) - Includes 30L Bin				

## Linen Skip (No Lid) - Economy White (Hygiene)



- Steel - anti-corrosion/epoxy powder coated
- All joints fully welded - assists with infection control
- 75mm twin wheel swivel castors
- Uprights are fixed at rear for swift bag removal

	Code	Description	Length	Width	Height	Warranty
1	LAC500830	Linen Skip - Stainless Steel - White Steel - Single	430 mm	430 mm	890 mm	5 Years
2	LAC500840	Linen Skip - Stainless Steel - White Steel - Double	430 mm	860 mm	890 mm	5 Years
3	LAC500850	Linen Skip - Stainless Steel - White Steel - Triple	430 mm	1290 mm	890 mm	5 Years
4	LAC500930	Buffer Disc and Reducing Bush to Suit Linen Skips (Each)				

### General Enquiries

P 1300 133 120 | E sales@aidacare.com.au | W www.aidacare.com.au



## Linen Skip (Foot Operated Lid) - Stainless Steel (Hygiene)

- All stainless steel construction
- All joints fully welded - assists with infection control
- Heavy duty grey rubber castors - 100mm swivel
- Polypropylene white plastic lid
- Uprights are fixed at rear for swift bag removal
- Large foot pedal to operate lid
- Lid labels - 1 set included

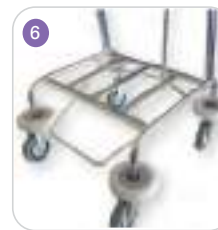
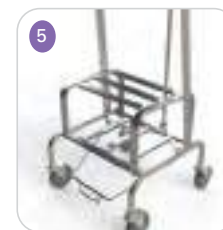

	Code	Description	Length	Width	Height	Warranty
1	LAC500860	Linen Skip Foot Operated Lid - Stainless Steel - Single	430 mm	460 mm	945 mm	5 Years
2	LAC500870	Linen Skip Foot Operated Lid - Stainless Steel - Double	430 mm	920 mm	945 mm	5 Years
3	LAC500880	Linen Skip Foot Operated Lid - Stainless Steel - Triple	430 mm	1360 mm	945 mm	5 Years
	LAC500915	Sticker Kit for LAC500636 (set of 4 stickers) - Replacement stickers				
4	LAC500636	Lid for Linen Skip - White (With stickers)				
5	LAC500920	Soiled Linen Skip Bag Support - Stainless Steel (For Half Sized 10 kg Bag) - Clip on (sold separately as singles)				
	LAC500925	Soiled Linen Skip Push Handle - Single - Stainless Steel				
6	LAC500930	Buffer Disc and Reducing Bush to Suit Linen Skips (Each)				
7	LAC500926	Waste Bin - Stainless Steel Frame (Clip on) - Includes 30L Bin				

## Linen Skip (Foot Operated Lid) - Economy White (Hygiene)

- Steel - anti-corrosion/epoxy powder coated
- All joints fully welded - assists with infection control
- 75mm twin wheel swivel castors
- Uprights are fixed at rear for swift bag removal
- Polypropylene white plastic lid
- Large foot pedal to operate lid
- Lid labels - 1 set included



	Code	Description	Length	Width	Height	Warranty
1	LAC500890	Linen Skip Foot Operated Lid - White Steel - Single	430 mm	430 mm	890 mm	5 Years
2	LAC500900	Linen Skip Foot Operated Lid - White Steel - Double	430 mm	860 mm	890 mm	5 Years
3	LAC500910	Linen Skip Foot Operated Lid - White Steel - Triple	430 mm	1290 mm	890 mm	5 Years
	LAC500915	Sticker Kit for LAC500636 (Set of 4 Stickers) - Replacement Stickers				
4	LAC500636	Lid for Linen Skip - White (With Stickers)				
5	LAC500930	Buffer Disc and Reducing Bush to Suit Linen Skips (Each)				

## Soiled Linen Bags

- Replacement Linen Bags to suit linen trolley
- Available as standard or waterproof
- All come with a 1 year warranty
- 15kg linen weight (10kg half size bags)

Code	Description	Code	Description	Code	Description
LAC353130	Drawstring S4 - White	LAC353060	Waterproof - White	LAC353105	Half Size (OH&S) - White
LAC353140	Drawstring S4 - Blue	LAC353020	Waterproof - Blue	LAC353106	Half Size (OH&S) - Blue
LAC353160	Drawstring S4 - Green	LAC353040	Waterproof - Green	LAC353107	Half Size (OH&S) - Green
LAC353170	Drawstring S4 - Red	LAC353050	Waterproof - Red	LAC353108	Half Size (OH&S) - Red
LAC353180	Drawstring S4 - Yellow	LAC353070	Waterproof - Yellow	LAC353109	Half Size (OH&S) - Yellow
LAC353190	Drawstring S4 - Purple	LAC353030	Waterproof - Black	LAC353110	Half Size (OH&S) - Purple



### DVA Contact Details

P 1300 888 052 | F 1300 787 052 | E [dva@aidocare.com.au](mailto:dva@aidocare.com.au)



For NDIS Item Code, refer to page: 508





## Soiled Linen Skip Lids - For Hygiene Range

- Replacement lid for Foot Operated Linen Trolley
- Lids available in a variety of colours

Code	Description	Warranty
LAC354110	Soiled Linen Skip Lid Plastic - Green	1 Year
LAC354130	Soiled Linen Skip Lid Plastic - Red	1 Year
LAC354140	Soiled Linen Skip Lid Plastic - White	1 Year
LAC354150	Soiled Linen Skip Lid Plastic - Yellow	1 Year
LAC500636	Lid for Linen Skip - White (With Stickers)	1 Year
LAC500915	Sticker Kit for LAC500636 (Set of 4 Stickers)	1 Year



LAC353950

## Bulk Soiled Linen

- Mobile Soiled Linen/Garbage trolley
- Transport and dispose soiled linen or garbage in the hospital or aged care environment
- 200mm grey rubber castor
- Hanging lockable door
- Pictured with gas assisted lid

Code	Description	Length	Width	Height	Warranty
LAC353950	Bulk Soiled Linen / Garbage Trolley - Small	1200 mm	625 mm	1240 mm	3 Years
LAC353960	Bulk Soiled Linen / Garbage Trolley - Large	1650 mm	800 mm	1200 mm	3 Years



Spring Base Option - LAC354064



## Moist Linen Trolley

- Mobile moist linen trolley
- Transport and dispose soiled linen in the hospital or aged care environment
- Galvanised base
- 125mm heavy duty nylon swivel castors

Code	Description	Length	Width	Height	Warranty
LAC354025	Moist Linen Trolley - Small	1000 mm	710 mm	790 mm	5 Years
LAC354030	Moist Linen Trolley - Large	1360 mm	750 mm	790 mm	5 Years
LAC354062	Spring Base Option - Small				1 Year
LAC354064	Spring Base Option - Large				1 Year
LAC500940	Lid to suit Moist Linen Trolley - Small				1 Year
LAC500945	Lid to suit Moist Linen Trolley - Large				1 Year
LAC500935	Push Handle				1 Year

## Wet & Dry Linen Trolley

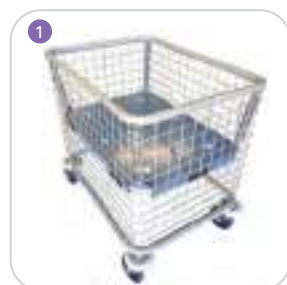

- Lightweight robust mesh construction
- Spring assisted adjustable base
- Spring covers reducing linen entrapment
- HDPE self lubricating, super quiet, anti rattle platform guides
- Heavy duty rubber swivel castors (2 x fixed on Medium & Large)
- 4 corner rotating wall buffers
- Pre zinc epoxy powder coated finish

	Code	Description	Length	Width	Height	Warranty
1	LAC353380	Wet & Dry Linen Trolley - Small + Spring Covers	800 mm	600 mm	800 mm	5 Years
2	LAC354190	Wet & Dry Linen Trolley - Medium + Spring Covers	1100 mm	680 mm	850 mm	5 Years
3	LAC354210	Wet & Dry Linen Trolley - Large + Spring Covers	1400 mm	800 mm	850 mm	5 Years
	LAC354220	Push Handle - Bolt On for Wet and Dry Linen Trolley - Medium				
	LAC354225	Push Handle - Bolt On for Wet and Dry Linen Trolley - Large				

### General Enquiries

P 1300 133 120 | E sales@aidacare.com.au | W www.aidacare.com.au

# Clean Linen & Storage



## Economy Clean Linen Trolley

- Durable lightweight construction
- Top tray with raised edging for additional storage
- Heavy duty swivel castors (1x directional castor on large models)
- Multi height push handle (large model only)
- 4 corner wall buffers
- Pre zinc epoxy powder coated finish
- Optional trolley cover available



	Code	Description	Length	Width	Height	Warranty
1	LAC353640	Clean Linen Trolley - Small - 2 Shelf + Top Tray + Push Handle - Economy - OPEN	920 mm	525 mm	1040 mm	5 Years
2	LAC353610	Clean Linen Trolley - Large - 3 Shelf + Top Tray + Push Handle - Economy - OPEN	1100 mm	550 mm	1400 mm	5 Years
3	LAC353620	Clean Linen Trolley - Small - 2 Shelf + Top Tray + Push Handle - Economy - CLOSED	920 mm	525 mm	1040 mm	5 Years
4	LAC353590	Clean Linen Trolley - Large - 3 Shelf + Top Tray + Push Handle - Economy - CLOSED	1100 mm	550 mm	1400 mm	5 Years
5	LAC353630	Clean Linen Trolley Front Cover - Economy Closed - Small				
6	LAC353600	Clean Linen Trolley Front Cover - Economy Closed - Large				



## Deluxe Clean Linen Trolley

- Durable lightweight aluminium panels & robust steel frame
- Two tone epoxy powder coated
- Optional top tray with raised edging for additional storage
- Tow hitch connection
- Heavy duty 175mm swivel castors (2 x total lock & 2 x directional lock)
- Multi height push handle at both ends
- 4 corner wall buffers



	Code	Description	Length	Width	Height	Warranty
1	LAC353560	Clean Linen Trolley - Large - 3 Shelf + Aluminium Shelf + Push Handle	1400 mm	800 mm	850 mm	5 Years
2	LAC353570	Clean Linen Trolley Front Cover - Large				
3	LAC353575	Clean Linen Trolley Tow Hitch - Large				

### DVA Contact Details

P 1300 888 052 | F 1300 787 052 | E [dva@aidacare.com.au](mailto:dva@aidacare.com.au)



For NDIS Item Code, refer to page: 508



## Linen Folding Table

- PVC work surface with raised sides
- 125mm swivel castors
- Robust construction
- Frame - Powder coated finish

Code	Description	Length	Width	Height	Warranty
LAC501000	Linen Folding Table - Fixed Height	1200 mm	650 mm	900 mm	3Years
LAC501010	Linen Folding Table - Electric	1200 mm	650 mm	900 mm	3Years



## Garment Dispensing Trolley

- Lightweight mild steel construction
- Large diameter heavy duty swivel castors
  - 125mm diameter for 16 & 20 tray trolleys
  - 150mm diameter for 30 tray trolley
- Corner buffers
- Push handle both ends
- Top cover
- Individual name tags
- Pre-treated epoxy powder coated finish

Code	Description	Length	Width	Height	Warranty
LAC353650	Garment Dispensing Trolley - 16 Baskets	1140 mm	700 mm	1355 mm	5 Years
LAC353660	Garment Dispensing Trolley - 20 Baskets	1140 mm	700 mm	1355 mm	5 Years
LAC353680	Garment Dispensing Trolley - 30 Baskets	1610 mm	700 mm	1355 mm	5 Years
LAC353470	Crate for Garment Dispensing Trolley	430 mm	325 mm	130 mm	5 Years

LAC353680



# Other Trolleys



## Utility Cart

- Transports or manoeuvres equipment and supplies in the home, hospital or aged care facility
- Large shelves hold various equipment and supplies
- Lightweight frame for easy manoeuvrability
- 125mm grey rubber swivel castors
- Available in black or white

Code	Description	Length	Width	Height	Weight Capacity	Warranty
LAC353011	Utility Cart - Black	960 mm	1030 mm	508 mm	136 kg	1 Year
LAC353010	Utility Cart - White	960 mm	1030 mm	508 mm	136 kg	1 Year



## Mobile Garbage Trolley

- Foot pedal operated lid - stainless steel and epoxy coated
- Channel frame with removable shock cord for secure plastic bag location
- Tapered uprights towards rear of frame for easy bag removal
- Bag support
- 75mm twin wheel swivel castors

Code	Description	Length	Width	Height	Warranty
LAC354250	Mobile Garbage Trolley	410 mm	415 mm	885 mm	5 Years



## Garbage Holder Wall Mounted

- Wall mounted garbage bag holder
- Foot operated lid is convenient and ideal for infection control
- Perforated sheet metal bag support
- White epoxy powder coated frame for corrosion resistance
- Comes with plastic lid
- Suits plastic or paper bags

Code	Description	Length	Width	Height	Warranty
LAC354240	Garbage Holder Wall Mounted	370 mm	400 mm	875 mm	3 Years

### DVA Contact Details

P 1300 888 052 | F 1300 787 052 | E [dva@aidacare.com.au](mailto:dva@aidacare.com.au)



For NDIS Item Code, refer to page: 508





### Cleaning Cart

- Smooth, easy-to-clean surface
- Zippered bag for easy trash removal
- Non-marking 8" (20.3cm) wheels and 4" (10.2cm) castors
- Optional locking compartment to keep cleaning chemicals out of reach

Code	Description	Length	Width	Height	Warranty
LAC353012	Cleaning Cart with Zippered Yellow Vinyl Bag	1264 mm	552 mm	975 mm	1 Year
LAC353013	Cleaning Cart Locking Cabinet	406 mm	286 mm	508 mm	1 Year



### Stock Trolley

- Lightweight robust construction
- Fixed perforated basket
- Push Handle on both ends
- Heavy duty 125mm polyurethane swivel castors
- Swivel buffer discs for wall protection
- Epoxy powder coated finish

Code	Description	Length	Width	Height	Warranty
WAT825510	Stock Trolley	700 mm	450 mm	950 mm	5 Years



### Garment Rack (Nesting)

- Lightweight durable construction
- Epoxy Powder coated frame
- 'T' base design allows easy access
- Swivel buffer discs
- 125mm lock castors
- Large hanging space
- Storage tray
- Multi position push handle fitted both ends
- Removable plastic storage containers

Code	Description	Length	Width	Height	Warranty
LAC353462	Garment Rack - Z Base	1425 mm	650 mm	1750 mm	5 Years



### File Trolley

- 25mm diameter push handle at both ends
- Lightweight
- Swivel wall buffers
- Storage Tray
- File trolley lid available

Code	Description	Length	Width	Height	Warranty
WAT900910	FileTrolley	950 mm	420 mm	980 mm	5 Years
WAT900920	FileTrolley Lid				



### Flow Chart Trolley

- Lightweight aluminium work platform 670mm x 800mm
- Spring assisted high / low adjustment
- 3x flow chart clips
- Pen & implement retainer
- Stainless steel uprights
- Epoxy powder coated top
- Stable 4x point pre-zinc treated epoxy powder coated contoured base
- 100mm total lock grey rubber castors

Code	Description	Length	Width	Height	Warranty
WAT900940	Flow Chart Trolley	670 mm	800 mm	850 - 1300 mm	5 Years

# Kitchen Trolleys

## Food Tray Dispensing Trolley



- Stainless steel top shelf
- Push handle at both ends
- Stainless steel frame
- 2 x directional lock castors
- 2 x directional swivel castors
- Corner buffers
- Can be manufactured to suit any tray size or configuration

Code	Description	Length	Width	Height	Warranty
1 WAT823500	FoodTray Dispensing Trolley - 8Tray - Stainless Steel - 125 mm Castors	460 mm	615 mm	1490 mm	5 Years
2 WAT823600	FoodTray Dispensing Trolley - 16 Tray - Stainless Steel - 150 mm Castors	575 mm	900 mm	1490 mm	5 Years
3 WAT824000	FoodTray Dispensing Trolley - 24 Tray - Stainless Steel - 150 mm Castors	575 mm	1330 mm	1490 mm	5 Years
WAT824700	FoodTray - 450 x 350 mm - Plastic - Small	450 mm	350 mm	-	-
WAT824710	FoodTray - 560 x 404 mm - Plastic - Regular	560 mm	404 mm	-	-
WAT824716	Cover for 8Tray Trolley - Pockets & 4 Grips				
WAT824717	Cover for 16Tray Trolley - Pockets & 4 Grips				
WAT824715	Cover for 24Tray Trolley - Pockets & 4 Grips				



## Tray Clearing Trolley

- Tray Clearing Trolley is ideal for hospital or nursing home environment
- Four 150mm swivel castors
- Stainless steel construction featuring two or three shelves design

Code	Description	Width	Depth	Height	Warranty
WAT824300	Tray Clearing Trolley 2 Shelf with Receptacles	1100 mm	500 mm	1000 mm	3 Years
WAT824500	Tray Clearing Trolley 3 Shelf with Receptacles	810 mm	500 mm	965 mm	3 Years

### DVA Contact Details

P 1300 888 052 | F 1300 787 052 | E [dva@aidacare.com.au](mailto:dva@aidacare.com.au)



For NDIS Item Code, refer to page: 508



## Beverage Trolley

- Top shelf with Urn Locating Lugs & 3 removable cutlery inserts
- Removable plastic pot on side for garbage etc
- Removable drip tray to capture water spillage from Urn
- Twin plate/saucer stackers
- Rail facility to accommodate three removable food trays
- Rail facility to accommodate three removable cup holder crates
- Castors – 125mm heavy duty grey rubber swivel
- Finish – Stainless steel

Code	Description	Width	Depth & Height	Height	Warranty
WAT823300	Beverage Trolley	600 mm	300 mm	600 mm	3 Years
WAT823400	Beverage Trolley with Fixed Shelves - Double	600 mm	300 mm	600 mm	3 Years



## Food Tray Clearing Trolley

- Lightweight stainless steel, fully welded construction
- 40mm safe edge on top of tray to prevent spills
- Push handle at both ends
- Stainless steel frame
- 4 x 125 mm grey rubber swivel castors

Code	Description	Length	Width	Height	Warranty
1 WAT824400	Food Tray Clearing Trolley - 2 Shelf	800 mm	500 mm	950 mm	5 Years
2 WAT824600	Food Tray Clearing Trolley - 3 Shelf	800 mm	500 mm	950 mm	5 Years
WAT824700	Food Tray - 450 x 350 mm - Plastic - Small	450 mm	350 mm	-	-



For Instrument /  
Dressing Trolleys  
Refer to Page 357



# Manual Handling - Lifters & Slings

# Contents

- P 186 Aspire Lifters
- P 190 Aspire Slings
- P 193 Aspire Swift Patient Mover
- P 194 Liko Lifters
- P 196 Liko Slings
- P 200 Ceiling Hoists
- P 206 Gantry Systems
- P 208 Oxford Lifters & Slings
- P 212 Invacare Lifters & Slings
- P 215 Kerry Lifters & Slings
- P 216 Stair & Specialty Lifters







## Lifters & Slings Overview

### FIM Score

FIM is a widely used assessment tool to classify a person's function from independence to total assistance in 7 levels:

What are the 7 levels?	Type of Lifter	Type of Sling
<b>COMPLETE INDEPENDENCE</b>		
<b>7</b> Complete Independence Another person is not required for the activity which is performed safely without modification or outside assistance within a reasonable time.	None	None
<b>6</b> Modified Independence Activity requires one or more of the following: an assistive device, more than reasonable time or safety (risk) considerations	None	None
<b>DEPENDENT</b>		
<b>5</b> Supervision or set up Someone required to help by observation or encouragement without contact.	Standing Lifter	None
<b>4</b> Minimal Assistance Someone required to help - by touching - subject makes 75% or more of the effort.	Standing Lifter	Standing Slings
<b>3</b> Moderate Assistance Someone required to help by more than touching - subject makes 50% - 75% of the effort.	Standing Lifter /Patient Lifter/ Multi Lifter	Standing Slings /Lifting Slings
<b>COMPLETE DEPENDENCE</b>		
<b>2</b> Maximal Assistance Complete dependence. Subject makes less than 50% but at least 25% of effort.	Patient Lifter	Lifting Slings
<b>1</b> Total Assistance Complete dependence. Subject makes less than 25% of effort.	Patient Lifter/ Overhead System	Lifting Slings

Please note that staff in ALL areas must have immediate access to at least one mobile passive hoist for use in the event of an emergency such as the retrieval of a patient who has fallen. A passive hoist suitable for a very heavy person should also be accessible within the facility/hospital and all staff should be aware of the system for accessing the hoist as required. (For example: in the event of an unplanned admission of a very heavy patient into Accident and Emergency).

### Selecting the Type of Sling for the Most Common Tasks

To simplify the process of sling selection, we have developed a chart to guide you in the appropriate use of each sling and task. There will, of course, be exceptions to this guide, but this reference enables a view of what tasks can be completed.

Lifter Type	Sling Type	Toilet	Commode to Bath	Chair to Chair	Bed to Chair	Floor to Bed	Chair to Commode	Emergency
Patient Lifter	Hygiene/Toileting	●		●			●	
Patient Lifter	General Purpose	●	●	●	●	●		
Patient Lifter	Quick Fit	●	●	●	●	●		●
Patient Lifter	Full Body	●		●	●	●		
Patient Lifter	Comfort	●	●	●	●	●		
Standing	Standing	●		●	●		●	

# Aspire Lifters



For NDIS Item Code, refer to page: 508

Brochures also available. Please contact us for a copy.

## Aspire A150F Aluminium Folding Lifter



Quick Release Yoke Attachment

One touch release and attach mechanism



Folds for Transport & Storage



Folds quickly and conveniently for storage or transport in the boot of the car

Build Quality

Strong powder coated aluminium frame



Ergonomic Handset



The latest slimline technology from Linak control panel

Safety

Critical features include emergency stop button



Off Set Leg Design



Provides additional accessibility around chairs and in the home

Quality Castors

2 x 75mm front castors  
2 x 100mm rear locking castors



Leg Function

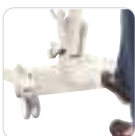

Simple foot operation to open or close legs for lifting stability or accessibility



Battery Electronics Frame

Code	Description	Overall Height	Overall Length	Overall Width	Lifter Weight	DVA:
LSS390600	Lifter A150F - Folding Lifter - Aluminium	1873 mm	1280 mm	660 mm	32.9 kg	AM01

### DVA Contact Details

P 1300 888 052 | F 1300 787 052 | E [dva@aidacare.com.au](mailto:dva@aidacare.com.au)



For NDIS Item Code, refer to page: 508





## Aspire A205 Aluminium Compact Lifter



### Easy Transportation & Storage



Is quick and convenient with tool free disassembly

### Ergonomic Handset



Linak technology fits neatly in the hand with an intuitive control panel

### Powered Leg Function



Opens and closes the legs for lifting stability or accessibility



### Quick Release Yoke with Safety Clips

One touch release and attach mechanism. Padded yoke for added patient safety



### Safety Stop Button

Emergency stop button, emergency lowering and anti-entrapment technology



### High Quality Castors

2 x 75mm front castors  
2 x 100mm rear locking castors



1 Year Warranty

3 Year Warranty

5 Year Warranty

**S.W.L**  
**205kg**

Battery

Electronics

Frame

Code	Description	Overall Height	Overall Length	Overall Width	Lifter Weight	DVA:
LSS390610	Lifter A205 - Patient Lifter - Aluminium	2045 mm	1135 mm	620 mm	38.1 kg	AM01

## Aspire 200 Steel Lifter



### Ergonomic Handles For Caregivers Comfort



Provide multiple grip points to suit carers of different heights and strengths

### Ergonomic Handset



Linak technology fits neatly in the hand with an intuitive control panel

### Powered Leg Function



Opens and closes the legs for lifting stability or accessibility

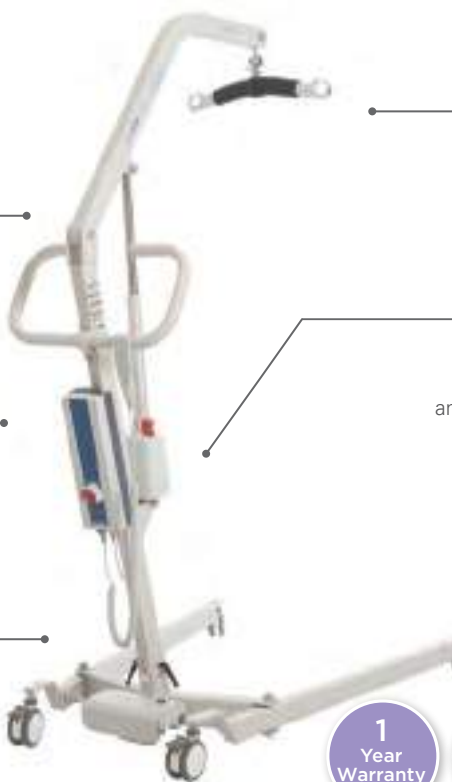

### Quick Release Yoke With Safety Clips

One touch release and attach mechanism. Padded yoke for added patient safety



### Safety Stop Button

Emergency stop button, emergency lowering and anti-entrapment technology



### High Quality Castors

2 x 75mm front castors  
2 x 100mm rear locking castors



1 Year Warranty

3 Year Warranty

5 Year Warranty

**S.W.L**  
**200kg**

Battery

Electronics

Frame

Code	Description	Overall Height	Overall Length	Overall Width	Lifter Weight	DVA:
LSS390620	Lifter 200 - Patient Lifter - Steel	1940 mm	1280 mm	665 mm	43.9 kg	AM01

### General Enquiries

P 1300 133 120 | E sales@aidacare.com.au | W www.aidacare.com.au



## Aspire A320 Aluminium Bariatric Lifter



### Ergonomic Handles & Support Arms



Provide multiple grip points. Folding support arms assist with stability or mobility

### Safety Stop Button



Emergency stop button, emergency lowering and anti-entrapment technology

### Powered Leg Function



Opens and closes the legs for lifting stability or accessibility

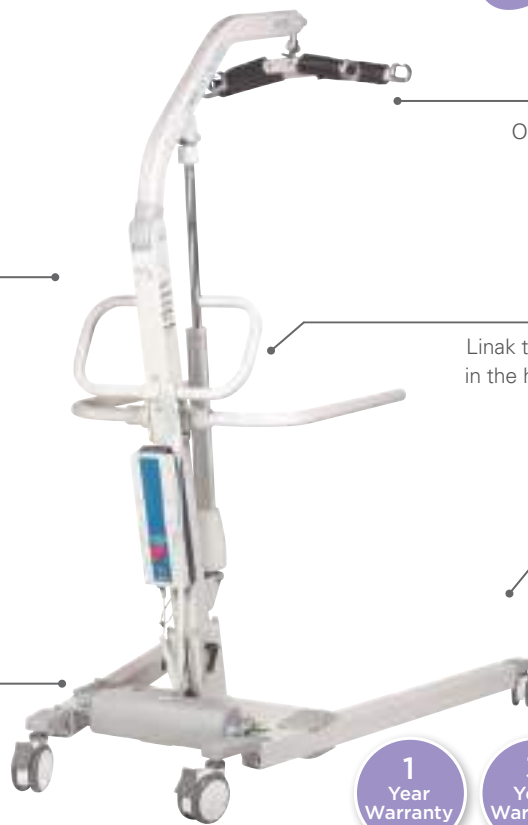

Quick Release 4 Point Yoke

One touch release and attach mechanism



Ergonomic Handset

Linak technology fits neatly in the hand with an intuitive control panel



High Quality Castors

2 x 100mm front castors  
2 x 125mm rear locking castors



Battery

Electronics

Frame

Code	Description	Overall Height	Overall Length	Overall Width	Lifter Weight
LSS390630	Lifter A320 - Bariatric Lifter - Aluminium	2165 mm	1505 mm	765 mm	63 kg

## Aspire A200S Aluminium Compact Standing Lifter



### Ergonomic Handset



Linak technology fits neatly in the hand with an intuitive control panel

### Safety Stop Button



Emergency stop button, emergency lowering and anti-entrapment technology

### Powered Leg Function

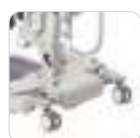

Opens and closes the legs for lifting stability or accessibility



Allows the user to hold on for support during the lifting process



Sling Bar with Grip Handles

Adjustable Depth Yoke with Safety Clips

Yoke is depth adjustable for optimal patient fit



Adjustable Padded Leg Rests

Provide comfort and support during transfers and can be adjusted to suit the patient



Quality Castors

2 x 75mm front castors  
2 x 75mm rear locking castors



Battery

Electronics

Frame

Code	Description	Overall Height	Overall Length	Overall Width	Lifter Weight	DVA:
LSS390640	Lifter A200S - Patient Stander - Aluminium	1455 mm	985 mm	590 mm	30.4 kg	AM01

### DVA Contact Details

P 1300 888 052 | F 1300 787 052 | E [dva@aidacare.com.au](mailto:dva@aidacare.com.au)



For NDIS Item Code, refer to page: 508





## Aspire 200S Steel Standing Lifter



Bullhorn Lifting Boom with Safety Clips

6 sling attachment points give the carer flexibility to perform the optimal lift in any scenario



Ergonomic Handset



Linak technology fits neatly in the hand with an intuitive control panel

Adjustable Padded Legrests

Provide comfort and support during transfers and can be adjusted to suit the patient



Safety Stop Button



Emergency stop button, emergency lowering and anti-entrapment technology

Quality Castors

2 x 75mm front castors  
2 x 100mm rear locking castors



Powered Leg Function

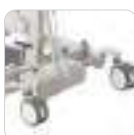

Opens and closes the legs for lifting stability or accessibility

1  
Year  
Warranty

3  
Year  
Warranty

5  
Year  
Warranty

S.W.L  
200kg

Battery
Electronics
Frame

Code	Description	Overall Height	Overall Length	Overall Width	Lifter Weight	DVA:
LSS390650	Lifter 200S - Patient Stander - Steel	1790 mm	1150 mm	655 mm	44.9 kg	AM01

## Aspire Pivot Frame



- Finely balanced central pivot line requires minimal manual handling effort to achieve the full pivot range and desired positioning
- Ergonomic positioning handle. In powered configuration, the accessible thumb-switch activates powered pivoting assistance
- Four clip sling attachment points
- Patients can be ideally positioned for safety and comfort during the transfer process
- Removable battery with charger included (powered)
- Designed for use with Aidacare Aspire Patient Lifters and Clip Slings, yet adaptable to many other lifter brands

Code	Description	Suits Lifters	Suits Slings	S.W.L	DVA:
LSS390665	Powered Pivot Frame	LSS390600, LSS390610, LSS390620, LS390630	Aspire CLIP Slings	227 kg	AM01
LSS390670	Manual Pivot Frame	LSS390600, LSS390610, LSS390620, LS390630	Aspire CLIP Slings	227 kg	AM01

## Aspire Weigh Scale



- Designed to be fitted on Aidacare Aspire Patient Lifters
- Allows for an accurate weight measurement to be taken by a carer when a patient is suspended in a sling
- Large weight capacity of up to 320kg
- Easy to read LCD display



Aspire In-Line Weigh Scale

Integrated Weigh Scale

Code	Description	Suits Lifters	S.W.L
LSS390680	In-Line Weigh Scale	LSS390600, LSS390610, LSS390620, LS390630	320 kg
LSS390675	Integrated Weigh Scale	LSS390610, LSS390620	200 kg

### General Enquiries

P 1300 133 120 | E sales@aidacare.com.au | W www.aidacare.com.au



# Aspire Slings

**I ♥ ndis** For NDIS Item Code, refer to page: 508

Brochures also available. Please contact us for a copy.

Size	Edging	Girth	Height	S.W.L
Small	●	65 cm - 95 cm	120 cm - 160 cm	200 kg
Medium	●	77cm - 110 cm	140 cm - 175 cm	200 kg
Large	●	98 cm - 135 cm	158 cm - 185 cm	300 kg
X-Large	●	118 cm - 157 cm	165 cm - 193 cm	300 kg
XX-Large	●	155 cm - 184 cm	170 cm - 193 cm	300 kg
XXX-Large	●	180 cm - 210 cm	170 cm - 193 cm	300 kg

## Sizing Colour Reference

All slings have reinforced edging that is colour coded for each size available making them easy to identify



## Aspire Deluxe General Purpose Sling



- Versatile sling offering body contoured fabric shaped for maximum patient comfort and support
- Available in Polyester or Mesh
- For FIM score 1 or 2



Code	Description	Size	Edge	S.W.L	Warranty	DVA:
LSS390700	Polyester - Loop	Small	●	200 kg	1 Year	AM02
LSS390705	Polyester - Loop	Medium	●	200 kg	1 Year	AM02
LSS390710	Polyester - Loop	Large	●	300 kg	1 Year	AM02
LSS390715	Polyester - Loop	X-Large	●	300 kg	1 Year	AM02
LSS390716	Mesh - Loop	Small	●	200 kg	1 Year	AM02
LSS390717	Mesh - Loop	Medium	●	200 kg	1 Year	AM02
LSS390718	Mesh - Loop	Large	●	300 kg	1 Year	AM02
LSS390719	Mesh - Loop	X-Large	●	300 kg	1 Year	AM02

### DVA Contact Details

P 1300 888 052 | F 1300 787 052 | E [dva@aidacare.com.au](mailto:dva@aidacare.com.au)

**I ♥ ndis** For NDIS Item Code, refer to page: 508

**aidacare**  
HEALTHCARE EQUIPMENT



Polyester

Mesh

## Aspire Deluxe General Purpose Sling with Head Support

- This sling has a comfortable padded head support with rigidisers for posture management
- Body contoured fabric
- Available in Polyester or Mesh
- For FIM score 1 or 2

Code	Description	Size	Edge	S.W.L	Warranty	DVA:
LSS390740	Polyester - Loop	Small	Red	200 kg	1 Year	AM02
LSS390745	Polyester - Loop	Medium	Yellow	200 kg	1 Year	AM02
LSS390750	Polyester - Loop	Large	Green	300 kg	1 Year	AM02
LSS390755	Polyester - Loop	X-Large	Blue	300 kg	1 Year	AM02
LSS3907551	Polyester - Loop	XX-Large	Black	300 kg	1 Year	AM02
LSS3907552	Polyester - Loop	XXX-Large	Purple	300 kg	1 Year	AM02
LSS390756	Mesh - Loop	Small	Red	200 kg	1 Year	AM02
LSS390757	Mesh - Loop	Medium	Yellow	200 kg	1 Year	AM02
LSS390758	Mesh - Loop	Large	Green	300 kg	1 Year	AM02
LSS390759	Mesh - Loop	X-Large	Blue	300 kg	1 Year	AM02
LSS3907591	Mesh - Loop	XX-Large	Black	300 kg	1 Year	AM02
LSS3907592	Mesh - Loop	XXX-Large	Purple	300 kg	1 Year	AM02
LSS390900	Polyester - Clip	Small	Red	200 kg	1 Year	AM02
LSS390905	Polyester - Clip	Medium	Yellow	200 kg	1 Year	AM02
LSS390910	Polyester - Clip	Large	Green	300 kg	1 Year	AM02
LSS390915	Polyester - Clip	X-Large	Blue	300 kg	1 Year	AM02
LSS390916	Mesh - Clip	Small	Red	200 kg	1 Year	-
LSS390917	Mesh - Clip	Medium	Yellow	200 kg	1 Year	-
LSS390918	Mesh - Clip	Large	Green	300 kg	1 Year	-
LSS390919	Mesh - Clip	X-Large	Blue	300 kg	1 Year	-



## Aspire Deluxe Hygiene Access Sling

- This sling offers generous underarm padding, quilted leg straps and a reinforced wide-cut back.
- Padded polyester fabric for increased patient comfort
- Security strap features velcro and buckle fastening for easy positioning and added safety
- For FIM score 2 or 3



Polyester

Code	Description	Size	Edge	S.W.L	Warranty	DVA:
LSS390760	Polyester - Loop	Small	Red	200 kg	1 Year	AM02
LSS390765	Polyester - Loop	Medium	Yellow	200 kg	1 Year	AM02
LSS390770	Polyester - Loop	Large	Green	300 kg	1 Year	AM02
LSS390775	Polyester - Loop	X-Large	Blue	300 kg	1 Year	AM02
LSS390776	Polyester - Loop	XX-Large	Black	300 kg	1 Year	AM02
LSS390777	Polyester - Loop	XXX-Large	Purple	300 kg	1 Year	AM02

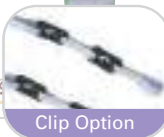

## Aspire Deluxe Hygiene Access Sling with Head Support

- This sling offers an adjustable head support for additional patient safety and comfort whilst maintaining all the benefits of the Deluxe Hygiene Access Sling
- Padded poly fabric and generous under arm padding for increased patient comfort
- Intuitive shape allows easier access for undressing and washing
- Security belt with velcro and buckle
- For FIM score 2 or 3



Polyester

Code	Description	Size	Edge	S.W.L	Warranty	DVA:
LSS390780	Polyester - Loop	Small	Red	200 kg	1 Year	AM02
LSS390785	Polyester - Loop	Medium	Yellow	200 kg	1 Year	AM02
LSS390790	Polyester - Loop	Large	Green	300 kg	1 Year	AM02
LSS390795	Polyester - Loop	X-Large	Blue	300 kg	1 Year	AM02
LSS390940	Polyester - Clip	Small	Red	200 kg	1 Year	AM02
LSS390945	Polyester - Clip	Medium	Yellow	200 kg	1 Year	AM02
LSS390950	Polyester - Clip	Large	Green	300 kg	1 Year	AM02
LSS390955	Polyester - Clip	X-Large	Blue	300 kg	1 Year	AM02



SUPER SOFT



MESH

## Aspire Deluxe Hammock Sling with Head Support



- This full body sling provides complete comfort and support for high needs patients.
- Two fabric options: – Mesh for general use – Supersoft for long term use
- Parasilk leg strap lining for easy positioning
- For FIM score 1 or 2



Super Soft



Mesh

Code	Description	Size	Edge	S.W.L	Wty	DVA:
LSS390800	Super Soft - Loop	Small	●	200 kg	1Year	AM02
LSS390805	Super Soft - Loop	Medium	●	200 kg	1Year	AM02
LSS390810	Super Soft - Loop	Large	●	300 kg	1Year	AM02
LSS390815	Super Soft - Loop	X-Large	●	300 kg	1Year	AM02
LSS390860	Mesh - Loop	Small	●	200 kg	1Year	AM02
LSS390865	Mesh - Loop	Medium	●	200 kg	1Year	AM02
LSS390870	Mesh - Loop	Large	●	300 kg	1Year	AM02
LSS390875	Mesh - Loop	X-Large	●	300 kg	1Year	AM02



Clip Option

## Aspire Deluxe Low Friction Sling



- This sling is appropriate to remain in situ for longer periods of time
- Parasilk material for easy positioning
- Supports the whole body and is suitable for general transfers, including: seated to seated and bed to chair transfers
- For FIM score 1 or 2



Parasilk

Code	Description	Size	Edge	S.W.L	Warranty
LSS390880	Parasilk - Loop	Small	●	200kg	1 Year
LSS390885	Parasilk - Loop	Medium	●	200kg	1 Year
LSS390890	Parasilk - Loop	Large	●	300kg	1 Year
LSS390895	Parasilk - Loop	X-Large	●	300kg	1 Year
LSS390960	Parasilk - Clip	Small	●	200kg	1 Year
LSS390965	Parasilk - Clip	Medium	●	200kg	1 Year
LSS390970	Parasilk - Clip	Large	●	300kg	1 Year
LSS390975	Parasilk - Clip	X-Large	●	300kg	1 Year

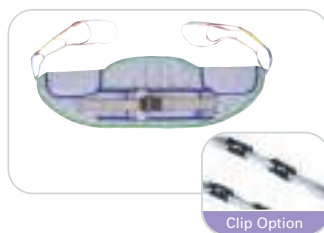

Clip Option

## Aspire Deluxe Standing Sling



- Intuitively designed, this sling offers generous underarm padding and a reinforced wide-cut back for comfort.
- Quilted and padded under arm to enhance patient comfort
- Padded back support with stays for stability and rigidity
- Security strap features velcro and buckle fastening for easy positioning and added safety.
- For FIM score 3 or 4



Polyester

Code	Description	Size	Edge	S.W.L	Warranty	DVA:
LSS390720	Polyester - Loop	Small	●	200 kg	1Year	AM02
LSS390725	Polyester - Loop	Medium	●	200 kg	1Year	AM02
LSS390730	Polyester - Loop	Large	●	300 kg	1Year	AM02
LSS390735	Polyester - Loop	X-Large	●	300 kg	1Year	AM02
LSS390736	Polyester - Loop	XX-Large	●	300 kg	1Year	AM02
LSS390737	Polyester - Loop	XXX-Large	●	300 kg	1Year	AM02

Code	Description	Size	Edge	S.W.L	Warranty
LSS390920	Polyester - Clip	Small	●	200 kg	1Year
LSS390925	Polyester - Clip	Medium	●	200 kg	1Year
LSS390930	Polyester - Clip	Large	●	300 kg	1Year
LSS390935	Polyester - Clip	X-Large	●	300 kg	1Year



Coloured Binding Tape

## Aspire Single Use Patient Sling



- General Purpose Sling with Head Support designed for single and exclusive patient use before disposal when soiled.

Code	Description	Size	Edge	Box Quantity	S.W.L	Warranty
LSS391100	Aspire Single Use Patient Sling	Small	●	Box/5	200 kg	1Year
LSS391110	Aspire Single Use Patient Sling	Medium	●	Box/5	200 kg	1Year
LSS391120	Aspire Single Use Patient Sling	Large	●	Box/5	200 kg	1Year
LSS391130	Aspire Single Use Patient Sling	X-Large	●	Box/5	200 kg	1Year



Non Woven Fabric



# Aspire Swift Patient Mover



For NDIS Item Code, refer to page: 508



## Aspire Swift Patient Mover



### Clip Sling Attachment Points



Allows a standing sling (optional accessory) with clips to be used for additional support where required

### Four User Contact Points



The foot platform, knee pad, seat pads and grip handle promote stability, support and comfort for the user - resulting in greater confidence in the transfer

### Height Adjustable Soft Knee Pad



Provides comfortable counter balance stability during transfers

### Width Adjustable Legs



Activated via 2 foot pedals, provide the ability to manoeuvre closer to furniture, toilets or beds for safer access

Assists the user to move independently from sitting to standing



Swing out of the way to allow user access and swing back into place to provide a comfortable seating surface



Provides a stable surface for the user to stand on and support their own weight



### Lockable 75mm Castors

The platform remains stationary while a user is transferring, while minimising the leg height for sufficient clearance beneath beds and furniture



**S.W.L**  
**185kg**

Code	Description	Overall Height	Overall Length	Overall Width	Knee Pad Height	Seat Pad Height	Handle Height	S.W.L	DVA:
LSS390590	Swift Patient Mover	1060 mm	820 mm	490 - 670 mm	250 - 490 mm	620 - 670 mm	900 mm	185 kg	AM01

### General Enquiries

P 1300 133 120 | E sales@aidacare.com.au | W www.aidacare.com.au



# Liko Lifters

I ♥ ndis For NDIS Item Code, refer to page: 508



## Golvo 9000 Patient Lifter

- Vertical lifting motion with flexible lift strap is ideal for horizontal lifting, ambulation and lifting from the floor
- Parallel base-width adjustment contributes to easier lifting of patients to/from chairs, beds and the floor
- Armrests help to support patients during ambulation, as well as making it easier for caregivers to manoeuvre the lift
- An extensive assortment of accessories is available including slings, slingbars and scales
- User display highlights device usage, including lift count, service required indicator and overloads
- Optional quick-release hook system means caregivers can easily and rapidly change a sling bar or install a scale
- Ergonomic hand control for lift operation displays both battery usage and overload indicators

Code	Description	Overall Height	Overall Length	Overall Width	Lifting Height	Material	S.W.L
LSS393100	Golvo 9000 Patient Lifter - Electric	2090 mm	1185 mm	735 - 1020 mm	571 - 1816 mm	Aluminium	200 kg



## Golvo 9000 LowBase Patient Lifter

- LowBase version allows for even greater clearance under low beds or stretchers versus the standard model
- Armrests help to support patients during ambulation, as well as making it easier for caregivers to manoeuvre the lift
- Vertical lifting motion with flexible lift strap is ideal for horizontal lifting, ambulation and lifting from the floor
- Parallel base-width adjustment contributes to easier lifting of patients or residents to/from chairs, beds and the floor as well as making it easier for caregivers to manoeuvre the lift
- User display highlights device usage, including lift count, service required indicator and overloads
- Optional quick-release hook system means caregivers can easily and rapidly change a sling bar or install a scale
- Ergonomic hand control for lift operation displays both battery usage and overload indicators
- An extensive assortment of accessories is available including slings, slingbars and scales

Code	Description	Overall Height	Overall Length	Overall Width	Lifting Height	Material	S.W.L
LSS393105	Golvo 9000 LowBase Patient Lifter - Electric	2090 mm	1185 mm	745 - 1028 mm	571 - 1816 mm	Aluminium	200 kg

### DVA Contact Details

P 1300 888 052 | F 1300 787 052 | E [dva@aidocare.com.au](mailto:dva@aidocare.com.au)

I ♥ ndis For NDIS Item Code, refer to page: 508





### Viking M Patient Lifter

- Ideal for meeting the lifting needs in small spaces
- Informative control box displays number of lift cycles, battery level, lift overload and service indicator
- Optional quick-release hook system which means caregivers can easily and rapidly change a slingbar or install a scale
- An extensive assortment of accessories is available including slings, slingbars and scales
- Optional armrests help support patients during ambulation as well as making it easier for caregivers to manoeuvre the lift
- Intuitive and ergonomically-designed hand control incorporates indicators for low battery level and when the Safe Working Load of the lift is exceeded

Code	Description	Overall Height	Overall Length	Overall Width	Lifting Height	Material	S.W.L
LSS393190	Viking M Patient Lifter - Electric	1340 - 2020 mm	1230 mm	690 - 1110 mm	420 - 1790 mm	Aluminium	205 kg



### Viking L Patient Lifter

- An everyday flexible lifting solution
- Informative control box displays number of lift cycles, battery level, lift overload and service indicator
- Optional quick-release hook system which means caregivers can easily and rapidly change a slingbar or install a scale
- An extensive assortment of accessories is available including slings, slingbars and scales
- Intuitive and ergonomically-designed hand control incorporates indicators for low battery level and when the Safe Working Load of the lift is exceeded
- Optional armrests help support patients during ambulation as well as making it easier for caregivers to manoeuvre the lift

Code	Description	Overall Height	Overall Length	Overall Width	Lifting Height	Material	S.W.L
LSS393180	Viking L Patient Lifter	2030 mm	1360 mm	695 - 1070 mm	460 - 1790 mm	Aluminium	205 kg



### Viking XL Patient Lifter

- Ideal for bariatric lifts and transfers
- Informative control box displays number of lift cycles, battery level, lift overload and service indicator
- Optional quick-release hook system which means caregivers can easily and rapidly change a slingbar or install a scale
- Optional armrests help support patients during ambulation as well as making it easier for caregivers to manoeuvre the lift
- Universal TwinBar 670 Slingbar offers additional sling space for patients of size
- Intuitive and ergonomically-designed hand control incorporates indicators for low battery level and when the Safe Working Load of the lift is exceeded
- An extensive assortment of accessories is available including slings, slingbars and scales

Code	Description	Overall Height	Overall Length	Overall Width	Lifting Height	Material	S.W.L
LSS393170	Viking XL Patient Lifter	2110 mm	1420 mm	815 - 1130 mm	540 - 1910 mm	Aluminium	300 kg



### RollOn Standing and Positioning Aid

- Sit to stand mobile aid supporting patients in mobilising themselves
- Padded rear supports provide security and are easily positioned and adjusted
- Safety lock ensures rear supports remain in an ideal position
- Width-adjustable base for optimal adaptability
- Crafted from aluminium for a lightweight design
- Lockable dual castors ensure stable positioning and usage

Code	Description	Overall Height	Overall Length	Overall Width	Material	S.W.L
LSS393360	RollOn Standing and Positioning Aid	1410 mm	890 mm	620 - 900 mm	Aluminium	160 kg



### Sabina II EE Standing Lifter

- Conventional patient lifting to a limited extent, lifting in the sitting position
- Powerful lifting motor ensures the smooth raising and lowering of patients
- The lower leg support and the foot rest can easily be removed for cleaning
- Base-width adjustment offers greater flexibility of use when lifting from a bed or chair, enhancing patient mobility
- Adjustable height settings accommodate a variety of different patient sizes

Code	Description	Overall Height	Overall Length	Overall Width	Lifting Height	Material	S.W.L
LSS393250	Sabina II EE Standing Lifter	900 - 1000 mm	1060 mm	695 - 1115 mm	1050 - 1725 mm	Steel	200 kg

Manual Handling - Lifters & Slings



# Liko Slings

**I ♥ ndis** For NDIS Item Code, refer to page: 508

Exclusive to:



## Original Highback Sling with Head Support



- This sling offers a reclined seating position for patients with poor head and trunk stability
- Separated leg supports ensure that the patient does not sit on the sling after use
- Can be used for floor transfers
- Easily adaptable to the patient with comfortable full body support

Code	Description	S.W.L	Code	Description	S.W.L
LSS394610	Polyester - Loops - XS	200 kg	LSS394660	Mesh - Loops - XS	200 kg
LSS394620	Polyester - Loops - SML	200 kg	LSS394670	Mesh - Loops - SML	200 kg
LSS394630	Polyester - Loops - MED	200 kg	LSS394680	Mesh - Loops - MED	200 kg
LSS394640	Polyester - Loops - LRG	200 kg	LSS394690	Mesh - Loops - LRG	200 kg
LSS394650	Polyester - Loops - XL	300 kg	LSS394700	Mesh - Loops - XL	300 kg



## Soft Original Highback Sling with Head Support



- Soft pliable plate provides comfortable support when lifting from the recumbent position
- This sling offers a reclined seating position for patients with poor head and trunk stability
- Can be used for floor transfers
- Separated leg supports ensure that the patient does not sit on the sling after use
- Easily adaptable to the patient with comfortable full body support

Code	Description	S.W.L
LSS394560	Polyester - Loops - MED Slim	200 kg
LSS394570	Polyester - Loops - MED	200 kg
LSS394580	Polyester - Loops - LRG	200 kg
LSS394590	Polyester - Loops - XL	500 kg
LSS394600	Polyester - Loops - XXL	500 kg



## ComfortSling with Head Support



- This sling provides comfortable sitting posture with good back support
- Adapts to the body's contours without the need for individual adjustment
- Allows the patient to remain in the sling after application and transfer
- Enhanced width increases patient comfort

Code	Description	S.W.L
LSS394710	Mesh - Loops - MED	200 kg
LSS394720	Mesh - Loops - LRG	200 kg
LSS394730	Mesh - Loops - XL	300 kg

### DVA Contact Details

P 1300 888 052 | F 1300 787 052 | E [dva@aidacare.com.au](mailto:dva@aidacare.com.au)



For NDIS Item Code, refer to page: 508





### SilhouetteSling with Head Support

- Pliable sling that adapts to the body and requires minimal wheelchair space
- Recommended for lifting to sitting to/from close-fitting wheelchairs
- Adjustable head support
- Provides a slightly reclined sitting posture suitable for patients with poor trunk stability
- Suitable to be used during bathing

Code	Description	S.W.L
LSS394450	Mesh - Loops - XS	200 kg
LSS394460	Mesh - Loops - SML	200 kg
LSS394470	Mesh - Loops - MED	200 kg
LSS394440	Mesh - Loops - LRG	200 kg



### HygieneSling

- Easy to apply sling that enables quick, smooth and secure transfers
- Equipped with a large opening that facilitates dressing and undressing
- Suitable to be used during bathing
- Works well with patients regardless of what clothing they are wearing
- Recommended for lifting to sitting to/from close-fitting wheelchairs

Code	Description	S.W.L
LSS394480	Polyester - Loops - SML	200 kg
LSS394490	Polyester - Loops - MED	200 kg
LSS394500	Polyester - Loops - LRG	200 kg
LSS394510	Polyester - Loops - XL	300 kg



### AmputeeSling

- Designed for safe and secure lifting of patients with amputated legs
- Offers a sitting posture that is slightly reclined with leg supports applied parallel to each under both thighs
- Supports patient with single and double leg amputations as well as patients with contractures
- Can also be used for non-amputee patients who are slender and require a smaller sling

Code	Description	S.W.L
LSS394514	Polyester - Loops - SML	200 kg
LSS394516	Polyester - Loops - MED	200 kg
LSS394518	Polyester - Loops - LRG	200 kg



### AmputeeSling with Head Support

- Designed for safe and secure lifting of patients with amputated legs
- Supports patient with single and double leg amputations as well as patients with contractures
- Adjustable head support
- Can also be used for non-amputee patients who are slender and require a smaller sling
- Offers a sitting posture that is slightly reclined with leg supports applied parallel to each under both thighs

Code	Description	S.W.L
LSS394520	Polyester - Loops - SML	200 kg
LSS394530	Polyester - Loops - MED	200 kg
LSS394540	Polyester - Loops - LRG	200 kg
LSS394550	Polyester - Loops - XL	300 kg



### UltraSling Bariatric Sling

- Designed for safe and comfortable lifting of bariatric patients
- Supports the entire back up to the shoulders
- Leg supports are installed individually on the sling bar, which gives the stomach space and the legs optimal support

Code	Description	S.W.L
LSS394400	Polyester - Loops - SHORT	500 kg
LSS394410	Polyester - Loops - REGULAR	500 kg
LSS394420	Polyester - Loops - LONG	500 kg
LSS394430	Mesh - Loops - REGULAR	500 kg



## Solo Highback Disposable Sling with Head Support



- Made of strong non-woven polypropylene fabric that is non-washable and engineered to be disposed of when it has become soiled or when the patient no longer requires it
- Designed for single patient use
- Can be used in most lifting situations
- Designed to adapt to the patient without any individual adjustments
- Supplied in boxes of 20 (Med-Lrg) & 8 (XL)

Code	Description	S.W.L
LSS394740	Polyester - Loops - MED Slim	200 kg
LSS394750	Polyester - Loops - MED	200 kg
LSS394760	Polyester - Loops - LRG	200 kg
LSS394770	Polyester - Loops - XL	500 kg



## SupportVest Standing Sling



- Comfortable sling which lifts behind the back and under the arms
- Soft padding redistributes pressure evenly
- Easy to use and requires only minimal individual adjustment so suit any patient
- Supportive belt holds the vest in place at all times

Code	Description	S.W.L
LSS394120	Polyester - Loops - SML	200 kg
LSS394130	Polyester - Loops - MED	200 kg
LSS394140	Polyester - Loops - LRG	200 kg
LSS394150	Polyester - Loops - XL	200 kg



## ComfortVest Standing Sling



- Sit-to-stand sling designed especially for patients who must avoid underarm pressure
- Ideal choice for patients who are paralysed on one side or have other conditions that inhibit underarm pressure
- Self-regulating tensioning function
- Outer vest supports the patient behind the back and outside the arms, while the inner waist belt prevents gliding and keeps the patient from sliding out of the vest

Code	Description	S.W.L
LSS394180	Polyester - Loops - SML	200 kg
LSS394190	Polyester - Loops - MED	200 kg
LSS394200	Polyester - Loops - LRG	200 kg
LSS394210	Polyester - Loops - XL	200 kg



## SafetyVest Standing Sling



- Sit-to-stand sling designed to assist patients with poor stability
- Self-regulating tensioning function ensures both caregiver and patient feel secure
- Padded fabric provides a high degree of friction and effectively prevents gliding
- Optional Sheepskin padding is available for even more comfort

Code	Description	S.W.L
LSS394160	Polyester - Loops - MED	200 kg
LSS394170	Polyester - Loops - LRG	200 kg



## HygieneVest Toileting Sling



- Designed for safe and comfortable transfers to and from the toilet
- Vest section firmly supports the upper body during transfer, while a generous opening leaves the lower body free for dressing and undressing
- Offers almost fully upright sitting, providing functional and safety advantages
- Works well in complicated situations, such as when lifting amputees or patients with poor muscle tone
- Available in Polyester

Code	Description	S.W.L
LSS394220	Polyester - Loops - SML	200 kg
LSS394230	Polyester - Loops - MED	200 kg
LSS394240	Polyester - Loops - LRG	200 kg
LSS394250	Polyester - Loops - XL	200 kg

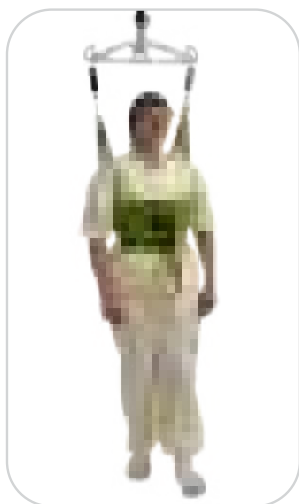

### MasterVest Gait Training Sling

- Versatile training aid that facilitates toilet visits, standing training, gait training, mobility training and placing patients into standing positions
- Reduces strain on caregivers while helping them deliver physical training
- Optional leg harness for improved support
- Transfers to an from the toilet can be accomplished easily and smoothly, reducing strain
- Lifts around the upper body and partly under the arms, and is best suited for patients that can support some of their body weight

Code	Description	S.W.L
LSS394260	Polyester - Loops - SML	200 kg
LSS394270	Polyester - Loops - MED	200 kg
LSS394280	Polyester - Loops - LRG	200 kg
LSS394290	Polyester - Loops - XL	200 kg
LSS394300	Polyester - Loops - XXL	200 kg
LSS394310	Leg Harness - SML	
LSS394320	Leg Harness - MED/LRG	
LSS394330	Leg Harness - XL/XXL	



### LiffPants Gait Training Sling

- Enables caregivers the ability to provide gait training to their patients while providing a sense of security for patients
- Offer freedom of movement while relieving the burden of body weight
- Provide necessary support to allow patient to move on his or her own with confidence
- Can be used on overhead or mobile patient lifters
- Available in Mesh

Code	Description	S.W.L
LSS394340	Mesh - Loops - SML	200 kg
LSS394350	Mesh - Loops - MED	200 kg
LSS394360	Mesh - Loops - LRG	200 kg
LSS394370	Mesh - Loops - XL	500 kg
LSS394380	Mesh - Loops - XXL	500 kg
LSS394390	Mesh - Loops - XXXL	500 kg



### TeddySling Paediatric Sling with Head Support

- Enable a relaxed, reclined seated position
- Can be used for all transfers to and from the horizontal and seated positions
- Perfect for transfers to and from the floor
- Equipped with a reinforced head support allowing a more upright seated position
- Ideal for children with spasticity problems
- Available in Teddy Patterned Polyester

Code	Description	S.W.L
LSS394100	Polyester - Loops - XS	50 kg
LSS394110	Polyester - Loops - SML	50 kg

## Liko Accessories

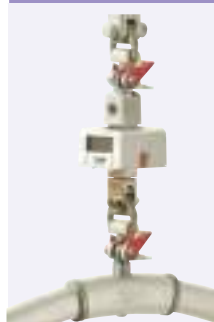

Liko Scale



Liko SlingBar



LikoStretch



Liko Clips

Please contact Aidacare to discuss delivery, installation and accessory options



# Ceiling Hoists

I ♥ ndis For NDIS Item Code, refer to page: 508



## P200 Portable Ceiling Hoist

- With its unique innovative design, the P200 is one of the lightest portable hoists on the market, yet it is capable of lifting up to 200kg
- Suitable for use with fixed ceiling tracks or mobile gantry systems
- The design and features make it perfect for use in community or nursing environments
- Quick Release System (QRS) allows for the P200 to be safely and easily attached or removed from the gantry or track system with an easy reacher
- Pneumatic handset is ideal for use in wet environments
- Emergency lowering allows for the safe lowering of the in emergency situations
- Client safety is assured with locking latches to secure slings in place for all lifts
- Room to Room transfer allows patients to be transferred without the need to be disconnected from the hoist

Code	Description	Height Range	Weight	S.W.L
LIC350110	P200 with Quick Release	Up to 2070 mm	4.8 kg	200 kg
LIC354170	Quick Release System reacher bar			



## CP200 Portable Ceiling Hoist

- Hoist can be reversed to act as a portable or fixed unit providing flexibility of use
- Slimline, low profile, padded carry bar that has six loop attachments as standard (four-point hook optional). Different width carry bars also available
- Low profile hoist unit is unobtrusive and provides greater lifting height
- All lifting and traversing operations have soft start/ stop to ensure smooth transfers for the patient
- A host of safety features
- Smooth running tape with large lifting range
- State of the art display with lift counter
- Ergonomically designed handset with hold to run clearly marked buttons and directional arrows requires minimum pressure to operate. Pneumatically controlled, making it safe for use in wet conditions
- Fire retardant cover completely encapsulates hoist
- Neat in track transformer, IP 67 rated
- Coloured direction indicators on hoist unit match hand control to ensure correct operation first time
- Emergency stop and manual emergency window

Code	Description	Height Range	Weight	S.W.L
LIC350105	CP200 Portable Ceiling Hoist	Up to 1960 mm	3.8 kg	200 kg

### DVA Contact Details

P 1300 888 052 | F 1300 787 052 | E [dva@aidocare.com.au](mailto:dva@aidocare.com.au)

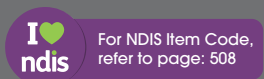





## Transactive Xtra Ceiling Hoist

- The Transactive XTRA fixed ceiling hoist allows for a large array of configurations, catering to changing needs, making it a suitable fixed lifting solution
- Digital display screen provides essential information for the user and caregiver
- Return to Charge (RTC) option automatically returns the hoist to its charger when required
- Manual wind down and raising allows the hoist to continue to be used during a power outage
- Low profile hoist unit is unobtrusive and provides greater lifting height
- Height range of up to 2080mm
- Pneumatic handset is ideal for use in wet environments
- Smooth lifting/running tape with large lifting range
- Emergency Lowering allows for the safe lowering of the in emergency situations
- Client safety is assured with locking latches to secure slings in place for all lifts
- Available in manual or powered traverse options

Code	Description	Weight	S.W.L
LIC350130	Manual Traverse - 130 kg	9.7 kg	130 kg
LIC350150	Manual Traverse - 160 kg	9.7 kg	160 kg
LIC350170	Manual Traverse - 200 kg	9.7 kg	200 kg
LIC350200	Manual Traverse - 270 kg	9.7 kg	270 kg
LIC350220	Manual Curtain Jumper - 270 kg		

Code	Description	Weight	S.W.L
LIC350140	Powered Traverse - 130 kg	10.4 kg	130 kg
LIC350160	Powered Traverse - 160 kg	10.4 kg	160 kg
LIC350180	Powered Traverse - 200 kg	10.4 kg	200 kg
LIC350190	Powered RTC Traverse - 200 kg	10.4 kg	200 kg
LIC350210	Powered Traverse - 270 kg	10.4 kg	270 kg
LIC350240	Powered RTC Traverse - 270 kg	10.4 kg	270 kg
LIC350230	Powered Curtain Jumper - 270kg		



## C380 Bariatric Fixed Ceiling Hoist

- The C380 is specifically designed to lift clients that exceed a standard hoists maximum weight capacity
- As the strongest Ceiling Track Hoist in its class, the C380 safely transfers bariatric clients with respect and dignity
- Low profile hoist unit is unobtrusive and provides greater lifting height
- Digital display screen provides essential information for the user and caregiver
- Return to Charge (RTC) option automatically returns the hoist to its charger when required
- Pneumatic handset is ideal for use in wet environments
- Smooth lifting/running tape with large lifting range
- Emergency Lowering allows for the safe lowering of the in emergency situations
- Client safety is assured with locking latches to secure slings in place for all lifts
- Available in manual or powered traverse options

Code	Description	Height Range	Weight	S.W.L
LIC350250	Manual Traverse	Up to 2080 mm	10.4 kg	380 kg
LIC350260	Powered Traverse	Up to 2080 mm	10.4 kg	380 kg
LIC350270	Powered Traverse & RTC	Up to 2080 mm	10.4 kg	380 kg



## LikoGuard L/XL Fixed Ceiling Hoist

- LikoGuard L & XL hoists combine powerful performance and enhanced safety design features
- Newly designed 450 SlingGuard slingbar encourages the correct placement of sling loops for greater confidence in safe patient mobilisation
- Innovative emergency stop and manual emergency lowering mechanism that is easy to reach, engage and operate with no tools, ladder or force needed
- Two choices of IPX7\* certified hand controls, one LED and one LCD backlit display. Both easy-to-use hand controls features battery, service and overload-indication. Advanced and intuitive LCD hand control offers graphical user interface with tracking of user and service data
- The LikoGuard lift system offers lift intervals of 2300mm and supports quick release hooks, fixed sling bars and stretchers
- Choice of on-wall or in-rail charger

Code	Description	Height Range	Weight	S.W.L
LIC359300	LikoGuard Large	Up to 2300 mm	14 kg	272 kg
LIC359310	LikoGuard X-Large	Up to 2300 mm	14 kg	363 kg

### General Enquiries

P 1300 133 120 | E sales@aidacare.com.au | W www.aidacare.com.au



## Multirall 200 Portable Ceiling Hoist

- The Multirall 200 hoist is a portable ceiling hoist that can also be used for room-to-room patient transfers
- Can be used to transfer a patient between rooms in a sitting position, easily moving from one rail system to another with the use of a transfer strap
- Quick sling bar change thanks to Q-link and Quick-release Hook
- It's portability makes it an excellent and economical solution for nursing home and hospital care situations where lifting needs are temporary
- Can be easily attached or removed with no tools and minimum effort from ceiling rails to facilitate convenient transport between rooms
- Can be mounted two ways for ease of use

Code	Description	Height Range	Weight	S.W.L
LIC359100	Multirall 200	Up to 1600 mm	8.7 kg	200 kg



## Likorall 200 Fixed Ceiling Hoist

- The Likorall 200 is an economical fixed ceiling hoist needed to manage everyday lifting situations
- The patented safety drum with speed limiter facilitates electrical emergency lowering
- Ideal for floor lifts in most environments
- Can be equipped with a special carriage for planned transfers between different rooms
- Ergonomically designed hand control
- Quick sling bar change thanks to Q-link and Quick-release Hook
- Simple wall charging via hand control

Code	Description	Height Range	Weight	S.W.L
LIC359490	Likorall 200	Up to 1800 mm	8.7 kg	200 kg



## Likorall 242 Fixed Ceiling Hoist

- The Likorall 242 ceiling hoist is designed to meet demanding lifting requirements
- The system is an ideal choice for those who want to move the lift motor along a track electronically with a transfer motor, or to control the system with a wireless hand control option
- The patented safety drum with speed limiter facilitates electrical emergency lowering
- Can be equipped with a special carriage for planned transfers between different rooms
- Wireless hand control
- Quick sling bar change thanks to Q-link and Quick-release Hook
- Simple wall charging via hand control or in rail charging

Code	Description	Height Range	Weight	S.W.L
LIC359535	Likorall 242 Manual	Up to 2000 mm	8.7 kg	200 kg
LIC359500	Likorall 242 Powered - Room to Room	Up to 2000 mm	8.7 kg	200 kg
LIC359510	Likorall 242 Manual - Room to Room	Up to 2000 mm	8.7 kg	200 kg



## Likorall 250 Fixed Ceiling Hoist

- The Likorall 250 ceiling hoist is designed to meet demanding lifting requirements
- The system is an ideal choice for those who want to move the lift motor along a track electronically with a transfer motor, or to control the system with a wireless hand control option
- The patented safety drum with speed limiter facilitates electrical emergency lowering
- Can be equipped with a special carriage for planned transfers between different rooms
- Wireless hand control
- Quick sling bar change thanks to Q-link and Quick-release Hook
- Simple wall charging via hand control or in rail charging

Code	Description	Height Range	Weight	S.W.L
LIC359520	Likorall 250 Powered	Up to 1800 mm	8.7 kg	250 kg
LIC359530	Likorall 250 Manual	Up to 1800 mm	8.7 kg	250 kg



## Mortuary Spreader Bar - 363kg

- Multiple hook positions - 13 total
- Simple and fast attachment
- Epoxy powder coat finish
- Central hanging pivot point
- Mild steel heavy wall tubular frame
- Suitable for use with ceiling mounted lift systems & floor hoists

Code	Description	Length	Height	S.W.L
LIC354195	Mortuary Spreader Bar - 363 kg	1580 mm	165 mm	363 kg



## Mortuary Spreader Bar - 200kg

- Optional Stretch Leveller allows for quick adjustment
- Can be used with a full lift sheet or with 4 lift straps
- Lightweight design weighing at 7.2 kg
- Optional quick-release hook system is also available
- Compatible with Liko patient lifters & Liko ceiling hoists, Prism ceiling hoists, Aidacare A320, A205 and 200 patient lifters

Code	Description	Length	Width	Height	S.W.L
LSS394920	Mortuary Spreader Bar - 200 kg	1263 mm	617 mm	227 mm	200 kg



## Lifting Frame w/ Electric Tilt & Level - 350kg

- 5 hanger positions – Adjustable
- Simple and fast attachment
- Epoxy powder coat finish
- Central hanging pivot point
- Aluminium extrusion main frame
- Rechargeable battery
- Battery level indicator

Code	Description	Length	Width	Height	S.W.L
LIC354194	Lifting Frame w/ ElectricTilt & Level	1194 mm	488 mm	286 mm	350 kg



## Mortuary Spreader Bar Lifting Strap

- To be used in conjunction with the Morgue Sling (4 bands) to allow optimal transfers in morgue applications
- Suitable for use with Fixed Ceiling Lifts
- Compatible with Liko patient lifters & Liko ceiling hoists, Prism ceiling hoists, Aidacare A320, A205 and 200 patient lifters

Code	Description	Length	Width
LIC354197	Lifting strap - Short - 2 eyelets	1300 mm	80 mm
LIC354198	Lifting strap - Medium - 5 eyelets	1500 mm	80 mm
LIC354199	Lifting strap - Long - 5 eyelets	2000 mm	80 mm





## Ceiling Hoist Considerations

Aidacare is an experienced supplier and installer of ceiling hoist systems.

We understand the risks involved in the installation and use of ceiling hoists and can help during early-stage specification and design to reduce risk and improve user-acceptance

Our systems are world-class and are accompanied by accredited installation guidelines which allow us to work with a range of installers. We are an ISO 9001 accredited company and consistently provide high-quality outcomes for Australia's largest Aged Care and Hospital providers

A wide range of motor & track options are available to suit client specifications



Some common examples are provided below

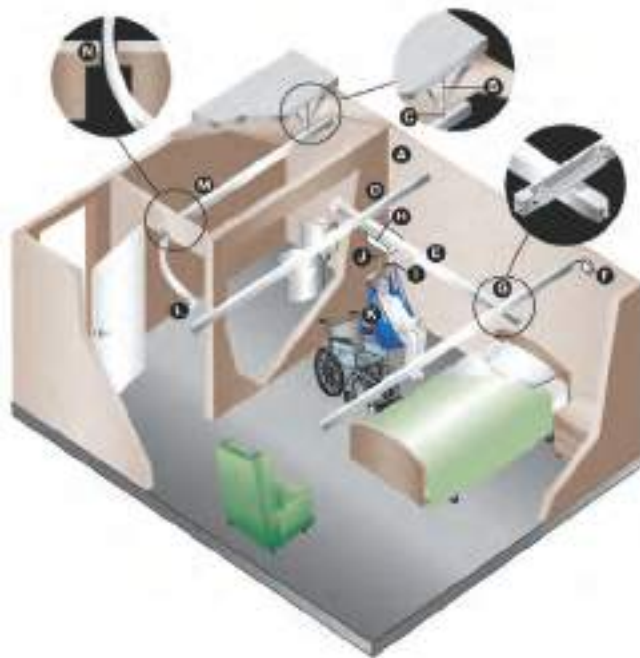

- A. Structural Attachment Point
- B. Threaded Rod
- C. Ceiling Bracket
- D. Ceiling Track
- E. Traverse Boom (Track)
- F. Charging Station
- G. X-Y Gantry
- H. Ceiling Lift Unit
- I. Carry Bar
- J. Lift Strap
- K. Sling
- L. Gait Assembly
- M. Linear Track
- N. Modified Door Header

## Consulting Solutions

Aidacare has extensive experience with installation and user-acceptance of ceiling systems. Simple things can be identified during planning to reduce risk in the installation and improve user and patient outcomes. We can assist in developing the best solution. Some examples of installations are provided below.

### Linear Track with Turn Table

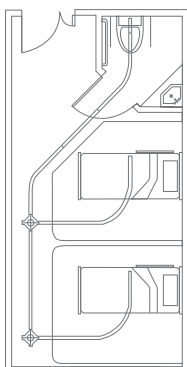

### Straight Monorail

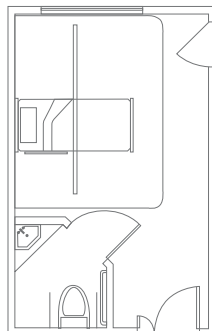

### Turntable

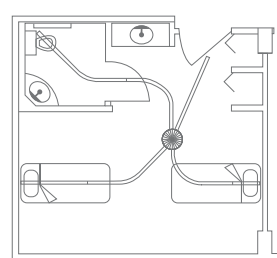

### J Track

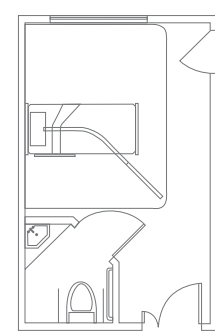



## Consulting Solutions

No two installations are alike. Aidacare has extensive experience dealing with many different installation substrates and scenarios. Aidacare utilises manufacturer-certified installation guidelines. Some of the more complex examples are shown below. This leads to a consistent high-quality outcome for our clients.

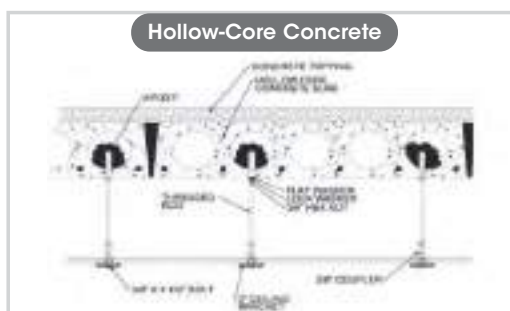
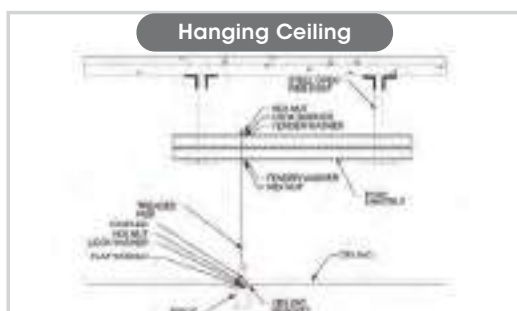
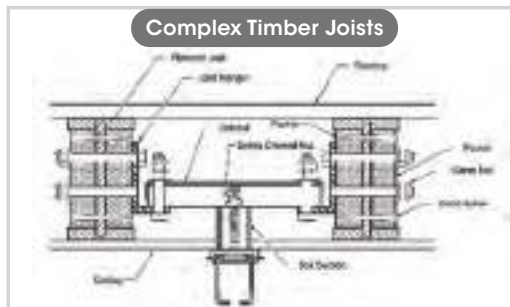
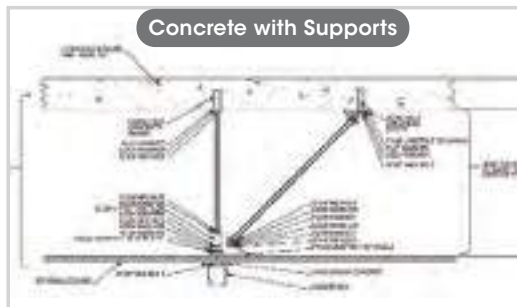

## Track Options



Exposed Track



Concealed Track



Rebar



45° Curve Track



90° Curve Track



Quick Curve

## Maintenance Safety

Aidacare fully-supports its installations with ongoing maintenance programs. Aidacare also assists our clients to develop their own internal maintenance regime.

## Training & User Acceptance

Aidacare Equipment Specialists offer user training and ongoing support. We also provide WHS signage with all equipment.

## Quality & Compliance

All systems are tested and installed in compliance with Australian Standard AS/NZ ISO 10535-2011 Hoists for the transfer of disabled persons. All systems are maintained in accordance with manufacturer's guidelines and in accordance with AS/NZ 3551-2012 Management Programs for Medical Equipment.

Aidacare is an ISO9001 compliant company. Aidacare uses an accredited network of trained installers, engineers, and load testers.





# Gantry Systems

**I ♥ ndis** For NDIS Item Code, refer to page: 508



**PRISM MEDICAL**

## FSG200 Free Standing Gantry

The FSG200 Free Standing Gantry system is designed to provide a safe, stable hoist track in places where a fixed ceiling track is not available or portable solution is required. When used in conjunction with a portable track hoist, such as the CP200, the system is perfect for home care, allowing users to extend the time they remain in their own home by years. It's a cost effective solution that is easy to transport and simple erect in minutes by either 1 or 2 people without the need for tools.

With complete safety, dignity and comfort for the client and carer the FSG200 Free Standing Gantry requires no structural alterations to the room or ceiling being effectively used to lift and transfer individuals from a bed, chair or similar fixture.

- Safe Working Load (SWL) - 200kg
- Compatible with CP200 Portable Track Hoist
- High-strength lightweight aluminium
- Adjustable in length from 1.9 - 2.85m, and in height from 2.1 - 2.5m
- Stable 0.87m 'feet'
- Built-in easy-slide trolley
- Floor level adjusters
- Star Handle securing screws
- Safety latch to prevent uprights retracting
- Securing Bolts and lynch pins

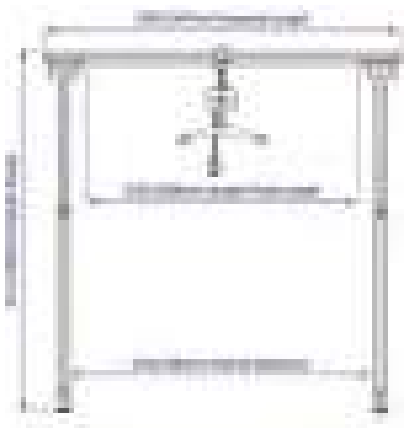

*FSG200 Free Standing Gantry is designed for use in conjunction with:*



P200 Ceiling Hoist  
LIC350110



CP200 Ceiling Hoist  
LIC350105

Code	Description	Useable Track Length	Width	Height	Foot Length	Unit Weight	Height Adjustments	SWL
LIC352105	FSG200 Free Standing Gantry	1900 - 2825 mm	2445 - 3387 mm	2141 - 2508 mm	870 mm	475 kg	75 mm	200 kg

**DVA Contact Details**

P 1300 888 052 | F 1300 787 052 | E [dva@aidocare.com.au](mailto:dva@aidocare.com.au)

**I ♥ ndis** For NDIS Item Code, refer to page: 508





PRISM MEDICAL

## Pressure Fit System

The unique and portable Pressure Fit System is light and compact – manufactured from high strength aluminium, each component part weighs no more than 12kg. The system is easy to transport and assemble, even where space is limited and other systems cannot be used. Minimal installation is required because the system works by exerting equal pressure between the floor and ceiling to stabilise the unit. It can be used to hoist between beds, chairs and toilets/commodes, either as a temporary or permanent solution.

- Safe Working Load (SWL) – 200kg
- Works with ceilings from 2133mm to 2743mm
- Span adjustable from 2100mm to 3000mm
- Adjustable in length from 1.85 - 2.75m, and in height from 2 - 2.75m
- Easy to read pressure gauge indicator ensures safe installation
- Can be used with all Freeway portable ceiling lifts

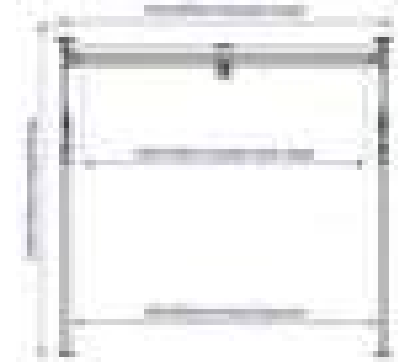

*SEQUOIA Free Standing Gantry is designed for use in conjunction with:*



P200 Ceiling Hoist  
LIC350110



CP200 Ceiling Hoist  
LIC350105

Code	Description	Useable Track Length	Width	Height	Unit Weight	SWL
LIC352120	Pressure Fit System	1856 - 2726 mm	2103 - 2973 mm	2046 - 2750 mm	27.1 kg	200 kg



### General Enquiries

P 1300 133 120 | E [sales@aidacare.com.au](mailto:sales@aidacare.com.au) | W [www.aidacare.com.au](http://www.aidacare.com.au)



# Oxford Lifters & Slings

**I ♥ ndis** For NDIS Item Code, refer to page: 508



## Oxford Presence Lifter

- Mobile patient lifter for transfer to a seated or lying position
- High lifting range accommodates transfers to higher surfaces
- Large load capacity of 227kg
- Robust epoxy powder coated frame construction makes it ideal for facilities
- Electric hand control operation
- Emergency lowering and raising
- Over-sized push handles for excellent manoeuvrability
- 100mm rear locking castors and 100mm front twin swivel castors
- Electric leg gating
- Suits a large range of patient slings
- Supplied with battery and charger
- Pictured with optional 4 point pivot frame (LSS377396)

Code	Description	Length	Width	Height	Leg Gait	Lift Range	Product Weight	S.W.L	Warranty
LSS377325	Presence Lifter	1460 mm	670 mm	1460 - 2061 mm	550 - 1020 mm	440 - 1910 mm	40 kg	227 kg	2 Years



## Oxford Advance Folding Homecare Lifter

- Mobile patient lifter for transfer to a seated or lying position
- Compact design can be folded easily for storage or transportation
- Epoxy powder coated frame
- Single speed handset control
- Emergency lowering
- Over-sized push handles for excellent manoeuvrability
- Manual foot operated leg gating and tapered leg design for close access
- Suits a large range of patient slings
- Supplied with battery and charger



Code	Description	Length	Width	Height	Leg Gait	Lift Range	Product Weight	S.W.L	Warranty	DVA:
LSS377300	Advance Folding Lifter	1300 mm	550 mm	1360 - 1860 mm	570 - 1000 mm	350 - 1860 mm	31.7 kg	155 kg	2 Years	AM01

### DVA Contact Details

P 1300 888 052 | F 1300 787 052 | E [dva@aidacare.com.au](mailto:dva@aidacare.com.au)

**I ♥ ndis** For NDIS Item Code, refer to page: 508





## Oxford Stature Lifter

- The Stature lifter recognises the true needs of the modern care environment, able to cope with even the most demanding and technical of patient handling situations
- Safe working load of 227kgs and great lifting ranges available (min 390mm, max 1550mm)
- The Stature can lift patients from the floor as well as accommodate transfers to higher surfaces, while allowing the choice of different sling systems
- Careful attention to product design ensures correct ergonomic usage, protecting both the patient and caregiver from injury
- Manual or powered cradles are available to assist with repositioning of patients
- The powered base allows the caregiver to open and close the legs without bending or twisting
- Ergonomic foot push-pad to assist with initiating movement

Code	Description	Length	Width	Height	Leg Gait	Lift Range	Product Weight	S.W.L	Warranty
LSS377373	Stature Lifter	1390 mm	1360 mm	1945 - 2130 mm	640 - 1230 mm	390 - 1550 mm	73.5 kg	227 kg	2 Years



## Oxford Journey Folding Standing Lifter

- Mobile compact patient lifter for transfer to a seated, lying or standing position
- Compact and lightweight allowing carers to manoeuvre in tight spaces
- Folds away for easy storage or transportation
- Unique adjustable 'cow-horn' shape supports a wide range of patient heights and sizes
- Adjustable knee pad
- Epoxy coated frame
- Electric hand control operation
- Emergency operation
- Easily manoeuvrable with 125mm rear locking castors and 75 mm front twin swivel castors
- Electric leg gating

Code	Model	Length	Width	Height	Leg Gait	Lift Range	Product Weight	S.W.L	Warranty	DVA:
LSS377305	Journey Standing Lifter	1000 mm	685 mm	1130 - 1600 mm	590 - 875 mm	720 - 1530 mm	40.2 kg	155 kg	2 Years	AM01



## Oxford Elevate Standing Lifter

- The Elevate is a high performance active lift designed to improve the lifting experience for both the caregiver and the patient
- It is both compact and sturdy with a safe working load rating of 200kgs
- Integrated digital weigh-scale assist with patient monitoring, designed with intuitive controls that require very little product training for caregivers
- The foot-tray is angled and utilises a lightweight plastic cover that can be easily removed for cleaning. In addition, by removing the foot-tray, the Elevate allows gait training for rehabilitation of patients
- The sculpted kneepad can be easily adjusted to improve patient comfort

Code	Model	Length	Width	Height	Leg Gait	Lift Range	Product Weight	S.W.L	Warranty
LSS377302	Elevate Standing Lifter	1100 mm	630 mm	1230 - 1700 mm	510 - 870 mm	945 - 1640 mm	62 kg	200 kg	2 Years

### General Enquiries

P 1300 133 120 | E sales@aidacare.com.au | W www.aidacare.com.au



## Oxford Ascend Standing Lifter

- With its great range of movement, the Ascend can transfer a patient from a low-seated position to fully extended with ease
- The Ascend is compact and easy to manoeuvre in confined spaces such as bathrooms and has many key design features that make it a truly flexible piece of equipment
- Its active lifting motion has been designed to encourage user participation, which ultimately promotes patient independence and well-being
- The kneepad can be adjusted within a 150mm operating range to improve patient comfort during repositioning
- The removable foot tray allows the Ascend to be used as a walking aid, great for patients that require gait-training
- Ergonomic foot pad to assist with initiating movement
- Careful attention to product design ensures correct ergonomic usage, protecting both the patient and carer from injury at all times

Code	Model	Length	Width	Height	Leg Gait	Lift Range	Product Weight	S.W.L	Warranty
LSS377350	Ascend Standing Lifter	1100 mm	630 mm	1070 - 1710 mm	510 - 885 mm	990 - 1665 mm	47 kg	170 kg	2 Years



## Oxford Pivot Frames

- The 4-point positioning cradle uses the Securi3 safety clip system and adjustment is made by rotating the cradle handle either down or up to obtain an upright or reclined position for the patient
- Both manual and powered cradles are available



Code	Description	Suits Hoists	Suits Slings	DVA:
LSS377395	Pivot Frame - 4 Point	LSS377300	Oxford Clip Slings	AM03
LSS377396	Pivot Frame - 4 Point	LSS377325/ LSS377373	Oxford Clip Slings	-
LSS377397	Pivot Frame Powered - 4 Point	LSS377325/ LSS377373	Oxford Clip Slings	-
LSS377385	Pivot Frame - 4 Point with weigh scale	LSS377325/ LSS377373	Oxford Clip Slings	-
LSS377386	Pivot Frame Powered - 4 Point with weigh scale	LSS377325/ LSS377373	Oxford Clip Slings	-
LSS377388	Lifter Pivot Frame - 6 Point to suit Oxford Presence Hoist	LSS377325	Oxford Clip Slings	-



## 6 Point Spreader Bar

- The 6-point spreader bar uses slings with webbing loops that allow positioning adjustments to be made by selecting different coloured loops

Code	Description
LSS377387	6 Point Spreader Bar - Oxford Advance Hoist
LSS377399	6 Point Spreader Bar with Weigh Scale - Oxford Lifters



## Standing Sling

- The standing sling is suitable for those patients who have a greater degree of weight bearing ability
- It allows excellent access for toileting and is easy to fit, providing quick and effective transfers
- The adjustable waist strap and the non-slip back pad ensures the sling does not ride up during the transfer
- This sling can be unsafe however, when used with the wrong patient, so a careful risk assessment is advised
- Available in three sizes - small, medium and large
- FIM Scores: 3 and 4

Code	Description	S.W.L	DVA:
LSS371952	Standing Sling - Small	200 kg	AM02
LSS371951	Standing Sling - Medium	200 kg	AM02
LSS371950	Standing Sling - Large	200 kg	AM02



## Quickfit Deluxe

- This sling is a development of the Quickfit design and is suitable for 95% of patients
- It can be used for amputees following assessment, and is available in sizes S to L
- FIM Scores: 1 and 2 and any other person from the floor

Code	Description	S.W.L	DVA:
LSS371698	Quickfit Deluxe Sling Poly - Small	227 kg	AM02
LSS371632	Quickfit Deluxe Sling Poly - Medium	227 kg	AM02
LSS371699	Quickfit Deluxe Sling Poly - Large	227 kg	AM02
LSS371697	Quickfit Deluxe Sling Mesh - Small	227 kg	AM02
LSS371700	Quickfit Deluxe Sling Mesh - Medium	227 kg	AM02
LSS371600	Quickfit Deluxe Sling Poly Padded - Medium	227 kg	AM02
LSS371703	Quickfit Deluxe Sling Poly Padded - Large	227 kg	AM02



## Quickfit

- This sling is an easy-to-fit, general-purpose sling designed to suit 85% of patients
- It is simple to use and is available in sizes S, M & L
- FIM Scores: 1 and 2 and any other person from the floor

Code	Description	S.W.L	DVA:
LSS371605	Quickfit Sling Poly - Small	227 kg	AM02
LSS371610	Quickfit Sling Poly - Medium	227 kg	AM02
LSS371614	Quickfit Sling Poly - Large	227 kg	AM02
LSS371612	Quickfit Sling Mesh - Small	227 kg	AM02
LSS371613	Quickfit Sling Mesh - Medium	227 kg	AM02
LSS371611	Quickfit Sling Mesh - Large	227 kg	AM02
LSS371606	Quickfit Sling Poly Padded - Small	227 kg	AM02
LSS371629	Quickfit Sling Poly Padded - Medium	227 kg	AM02
LSS371615	Quickfit Sling Poly Padded - Large	227 kg	AM02



## Quickfit Access Toileting

- This sling is designed specifically to facilitate the toileting procedure by allowing the removal of clothing
- It is NOT a general-purpose sling and will suit only 25% of patients
- Patients must be in a sitting position to use this sling
- FIM Scores: 2 or 3 following careful assessment

Code	Description	S.W.L
LSS371649	Access Toileting Sling Poly - Small	227 kg
LSS371955	Access Toileting Sling Poly - Medium	227 kg
LSS371967	Access Toileting Sling Poly - Large	227 kg



Comfort Sling



Comfort Sling Access

## Comfort Sling (for Pivot Frame)

- This is a more specialised sling
- Allows correct positioning to be made via the 4-point cradle and uses the Securi3 sling connection system ensuring no inadvertent detachment of the sling from the cradle
- Incorporates a removable comfort pad for head support and fits to give full protection for patients who go into extension or have involuntary movements or behavioural problems
- FIM Scores: 1 and 2 and any other person from the floor

Code	Description	S.W.L
LSS371639	Comfort Sling Poly - Extra Small	227 kg
LSS371643	Comfort Sling Poly - Small	227 kg
LSS371644	Comfort Sling Poly - Medium	227 kg
LSS371645	Comfort Sling Poly - Large	227 kg
LSS371640	Comfort Sling Poly - Extra Large	227 kg
LSS371969	Comfort Sling Access Poly - Small	227 kg
LSS371970	Comfort Sling Access Poly - Medium	227 kg
LSS390515	Comfort Sling Access Poly - Large	227 kg



# Invacare Lifters & Slings

**I ♥ ndis** For NDIS Item Code, refer to page: 508



## Birdie Compact

- 550mm width and can be folded and unfolded without the need for tools or special skills required. Ideal for the nursing or home care environments where space and time are at a premium
- The only lifter that is TÜV certified that is this narrow – unique to the market
- All attachments are quick release, making it very easy to change when required
- Intelligent control system includes a service reminder, emergency operation, audio battery alarm, and battery indicator
- Manual leg width adjustment
- Supplied with yoke attachment
- Electric emergency lowering up and down

### Optional Accessories:

- Pivot Frame (LSS364112)
- Full range of slings



Code	Model	Length	Width	Leg Gait	Lift Range	Product Weight	Safe Working Load	DVA:
LSS364100	Birdie Compact	1000 mm	550 mm	550 - 890 mm	530 - 1600 mm	36 kg	150 kg	AM01



## Birdie 170

- 680mm width and can be folded and unfolded without the need for tools or special skills required. Ideal for the nursing or home care environments where space and time are at a premium
- All attachments are quick release, making it very easy to change when required
- Intelligent control system includes a service reminder, emergency operation, audio battery alarm, and battery indicator
- Available in manual or electric leg
- Supplied with yoke attachment
- Electric emergency lowering up and down

### Optional Accessories:

- Pivot Frame (LSS364112)
- Full range of slings

Code	Model	Length	Width	Leg Gait	Lift Range	Product Weight	Safe Working Load	DVA:
LSS364110	Birdie 170 - Electric	1150 mm	680 mm	680 - 1040 mm	470 - 1740 mm	42 kg	170 kg	AM01
LSS364111	Birdie 170 - Manual	1150 mm	680 mm	680 - 1040 mm	470 - 1740 mm	42 kg	170 kg	-



## Jasmine

- Safe patient handling with up to 200 kg
- Wide opening base and high lifting mechanism, provides wide range of application
- Intelligent control system includes a service reminder, emergency operation, audio battery alarm, and battery indicator
- Supplied with yoke attachment
- Electric emergency lowering up and down

### Optional Accessories:

- Pivot Frame (LSS378105)
- Weighing Device (LSS386201)
- Full range of slings

Code	Model	Length	Width	Leg Gait	Lift Range	Product Weight	Safe Working Load
LSS378110	Jasmine	1340 mm	690 mm	690 - 1050 mm	540 - 1920 mm	43 kg	200 kg

### DVA Contact Details

P 1300 888 052 | F 1300 787 052 | E [dva@aidacare.com.au](mailto:dva@aidacare.com.au)

**I ♥ ndis** For NDIS Item Code, refer to page: 508





## Roze Standing Lifter

- Compact, manoeuvrable and provides an easy, safe and comfortable assisted transfer for patients in care or those with rehabilitation needs
  - 200kg lifting capacity with a compact 68cm base makes it easier to manoeuvre in smaller spaces like bedrooms and bathrooms with heavy patients
  - Constructed of a combination of aluminium and steel, making it lighter, so a carer can push the lifter smoothly and with reduced force
  - Added safety features include an emergency stop button, an emergency mechanical descent system and an anti-entrapment device, (which stops the boom lowering if it meets resistance)
  - Spare battery and external charger as standard
  - Manual emergency lowering
- Optional Accessories:**
- Full range of slings

Code	Description	Length	Width	Leg Gait	Lift Range	Product Weight	Safe Working Load
LSS378000	Roze	1120 mm	660 mm	660 - 1050 mm	940 - 1610 mm	53 kg	200 kg



## General Purpose Sling

- This sling provides easy fitting and good support for patients with some upper body control

Code	Description	S.W.L
LSS373400	General Purpose Poly - Small	205 kg
LSS373000	General Purpose Poly - Medium	205 kg
LSS373205	General Purpose Poly - Large	300 kg
LSS374305	General Purpose Poly - Extra Large	300 kg
LSS373495	General Purpose Mesh - Small	205 kg
LSS373500	General Purpose Mesh - Medium	205 kg
LSS373505	General Purpose Mesh - Large	300 kg



## General Purpose Sling with Head Support

- This sling fits easily to a patient in bed or a chair, providing excellent upper body and head support
- Recommended for lifting from the floor and general lifting of the less secure patient.

Code	Description	S.W.L
LSS374300	General Purpose Poly with Head Support - Extra Small	205 kg
LSS374909	General Purpose Poly with Head Support - Small	205 kg
LSS373200	General Purpose Poly with Head Support - Medium	205 kg
LSS373300	General Purpose Poly with Head Support - Large	300 kg
LSS374310	General Purpose Poly with Head Support - Extra Large	300 kg
LSS374912	General Purpose Poly with Head Support - Extra Extra Large	300 kg
LSS373700	General Purpose Mesh with Head Support - Small	205 kg
LSS373704	General Purpose Mesh with Head Support - Medium	205 kg
LSS373706	General Purpose Mesh with Head Support - Large	300 kg
LSS374910	General Purpose Mesh with Head Support - Extra Large	300 kg



## General Purpose Paediatric Sling

- Available in three sizes. The sling provides easy fitting and good support for children or small adults
- Recommended for general lifting with children or small adults

Code	Description	S.W.L
LSS374915	General Purpose Paediatric Poly - Extra Small	205 kg
LSS374920	General Purpose Paediatric Poly - Small	205 kg
LSS374925	General Purpose Paediatric Poly - Medium	205 kg



## General Purpose Hygiene Sling with Head Support

- Available in five sizes in a choice of fabric or mesh. The sling provides easy removal of clothing or toilet transfers. Recommended for general toilet transfers for the less secure patient

Code	Description	S.W.L
LSS374916	General Purpose Hygienic Poly with Head Support - Small	205 kg
LSS375500	General Purpose Hygienic Poly with Head Support - Medium	205 kg
LSS375600	General Purpose Hygienic Poly with Head Support - Large	300 kg
LSS375610	General Purpose Hygienic Poly with Head Support - Extra Large	300 kg
LSS375850	General Purpose Hygienic Mesh with Head Support - Extra Small	205 kg
LSS375900	General Purpose Hygienic Mesh with Head Support - Small	205 kg
LSS375100	General Purpose Hygienic Mesh with Head Support - Medium	205 kg
LSS361310	General Purpose Hygienic Mesh with Head Support - Large	300 kg
LSS375910	General Purpose Hygienic Mesh with Head Support - Extra Large	300 kg



## Supreme Hygienic Sling With Buckle

- This sling is excellent for transfers onto a toilet as it provides an open area from the middle of the back to the middle of the thigh. This sling has a buckle waist strap and features generous padding around the patient's midsection and under arms

Code	Description	S.W.L
LSS376100	Supreme Hygiene Poly - Small	205 kg
LSS376200	Supreme Hygiene Poly - Medium	205 kg
LSS376300	Supreme Hygiene Poly - Large	300 kg



## Hygienic Sling With Buckle

- This sling is excellent for transfers onto a toilet as it provides an open area from the middle of the back to the middle of the thigh. This sling has a buckle waist strap and features generous padding around the patient's midsection and under arms. Recommended for general toilet transfers

Code	Description	S.W.L
LSS376420	Hygienic Poly - Medium	205 kg
LSS376422	Hygienic Poly - Large	300 kg



## Hammock Sling

- The sling provides support and security for lifting from a bed or the floor. The patient must roll on to, and off, the sling. When fitted full head support is provided. Recommended for single or double lower limb amputees and lifting from the floor, and because weight is not taken by the patient's thighs

Code	Description	S.W.L
LSS375010	Hammock Poly - Medium	205 kg
LSS375015	Hammock Mesh - Medium	205 kg
LSS375020	Hammock Mesh - Large	300 kg



## Pivot Sling

- The sling allows a patient to be lifted in either a sitting or lying position. The ability to position a patient in the sitting posture greatly assists correct seating. A more open lift. Recommended for general lifting including floor lifting

Code	Description	S.W.L
LSS386702	Pivot Poly - Small	205 kg
LSS386701	Pivot Poly - Medium	205 kg
LSS373900	Pivot Poly - Large	205 kg
LSS374000	Pivot Poly - Extra Large	205 kg
LSS374590	Pivot Mesh - Extra Small	205 kg
LSS374600	Pivot Mesh - Small	205 kg
LSS374700	Pivot Mesh - Medium	205 kg
LSS374800	Pivot Mesh - Large	205 kg
LSS374900	Pivot Mesh - Extra Large	205 kg
LSS374905	Pivot Mesh - Extra Extra Large	205 kg



## Pivot Hygiene Sling

- The sling provides easy removal of clothing for toilet transfers and bathing.
- Recommended for general toilet transfers and bathing

Code	Description	S.W.L
LSS375390	Pivot Hygiene Mesh - Medium	205 kg
LSS375400	Pivot Hygiene Mesh - Large	205 kg



## Standup Sling

- Designed to lift the patient comfortably from a seated position into a relaxed upright position. The StandUp Sling supports the patient from waist to shoulder while allowing the arms to move freely so that the hands can reach naturally to grip the support rails as the patient rises

Code	Description	S.W.L
LSS376405	Standup Loops - Medium	205 kg
LSS376410	Standup Loops - Large	205 kg
LSS376395	Standup Buckle - Medium	205 kg
LSS376400	Standup Buckle - Large	205 kg
LSS376415	Standup Velcro Loops - Universal	205 kg
LSS373315	Standup Velcro Keyhole - Universal	205 kg

# Kerry Lifters & Slings



For NDIS Item Code, refer to page: 508



## Kerry Ezy Lift Lifter

- Mobile patient lifter for transfer to a seated or lying position
- Ideal for use with weight scale or pivot frame
- Large load capacity of 225kg
- Electric leg gating
- Suits a large range of patient slings
- Supplied with battery and charger
- Robust epoxy powder coated frame construction makes it ideal for aged care facilities
- Dual speed hand control operation
- Emergency lowering and raising
- Oversized push handles for excellent manoeuvrability

Code	Description	Length	Width	Height	Leg Gait	Lift Range	Product Weight	S.W.L	Warranty
LSS379800	Ezy Lift	1440 mm	690 mm	1315 mm	540 - 1000 mm	485 - 1730 mm	53 kg	225 kg	2 Years



## Kerry Multi Lift Lifter

- Mobile patient lifter for transfer to a lying, seated or standing position
- Versatile as a standing or conventional lifting hoist or a walking tutor
- Robust epoxy powder coated frame construction makes it ideal for aged care facilities
- Wall mounting bracket for boom spreader bar
- Dual speed electric hand control operation
- Emergency lowering and raising
- Manoeuvrability + Push handle
- 150mm rear locking castors and 100mm front twin swivel castors
- Electric leg gating
- Suits a large range of patient slings
- Supplied with battery and charger

Code	Description	Length	Width	Height	Leg Gait	Lift Range	Product Weight	S.W.L	Warranty
LSS379300	Multi Lift Lifter	1310 mm	700 mm	1220 mm	535 - 970 mm	370 - 1725 mm	58 kg	180 kg	2 Years



## Kerry Weigh Scale

- Digital weigh scale fits on the hoist range to weigh a patient in transfer
- Replaces existing yoke on a hoist with no loss of lift height

Code	Description	S.W.L	Warranty
LSS383700	Weigh Scale	400 kg	1 Year

### General Enquiries

P 1300 133 120 | E sales@aidacare.com.au | W www.aidacare.com.au



### Standing Slings

- Comfortable & easy to fit
- High density foam for user comfort and support
- Machine Washable
- FIM Score: 3 - 4 (User needs moderate assistance)

Code	Description	S.W.L	Warranty
LSS378600	Standing Sling - Small / Medium	250 kg	1 Year
LSS378800	Standing Sling - Large	250 kg	1 Year
LSS378700	Standing Sling with Buckle - Small / Medium	250 kg	1 Year
LSS378900	Standing Sling with Buckle - Large	250 kg	1 Year



### Seating Slings

- Comfortable & easy to fit
- High density foam for user comfort and support
- For use with standing hoists
- Colour coded straps
- Machine washable
- FIM Score: 3 - 4 (User needs moderate assistance)

Code	Description	S.W.L	Warranty
LSS379200	Seating Sling - Small / Medium	250 kg	1 Year
LSS379000	Seating Sling - Large	250 kg	1 Year

## Stair & Specialty Lifters

Aidacare stock a wide range of 'Specialty Lifters' for your every need.

1. Stairs Lifters
2. Portable Overhead Lift Units
3. Pool Lifters
4. Ceiling Track Systems
5. Wheelchair Lifters



**Aidacare Home  
Modification Services**

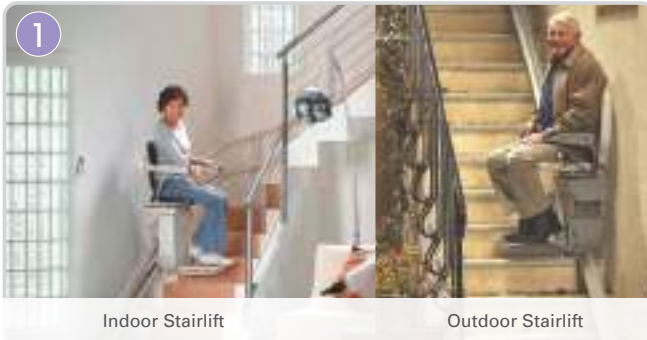

Indoor Stairlift

Outdoor Stairlift



Wheelchair Platform Lift

Wheelchair Platform

Step Lift

Outdoor Elevator

Call us for your free measure and quote!



CONTACT US  
FOR A BROCHURE



# VOGUE WALKERS



The stylish European designed Aspire Vogue Walkers are a lightweight, versatile range with a sturdy frame and easy to fold locking system, suitable for compact transportation when folded. Manufactured with the utmost attention to quality, including soft ride wheels, advanced deluxe brakes, ergonomic handles and a forearm option.

Enjoy your independence with peace of mind, in style.



[www.aspirecare.com.au](http://www.aspirecare.com.au)  
1300 133 120



# Manual Handling - Other

# Contents

- P 219 Transfer Boards & Slide Sheets
- P 221 Transfer & Walk Belts
- P 222 Other Transfer Aids



# Transfer Boards & Slide Sheets



For NDIS Item Code, refer to page: 508



## Aspire Lifecomfort Evacuation Sheet



Designed for the emergency evacuation of the non-ambulant person, the Aidacare LIFECOMFORT Evacuation Sheet:

- Fits discreetly underneath the resident's mattress
- Allows bed making to occur as normal
- Remains readily accessible in case of emergency evacuation
- Is fire retardant and highly durable

The Evacuation Sheet was designed to help rescue teams, carers or nurses to slide the mattress and resident along any floor surface or even downstairs, increasing resident safety and preventing injury to nursing staff in emergency action situations.



Suitable for use by one or two carers



Corner Straps  
Keeps the Evacuation Sheet in position

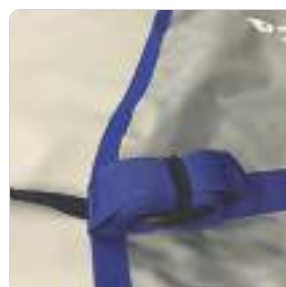

Cross Straps  
Secured over the resident & mattress



Pulling Straps  
Located at head & foot ends



Code	Description	Width	Length	DVA:
TSE672526-S	Evacuation Sheet - Single	720 mm	1900 mm	-
TSE672526	Evacuation Sheet - King Single	900 mm	1900 mm	AB13

### General Enquiries

P 1300 133 120 | E sales@aidacare.com.au | W www.aidacare.com.au



## SallyBoards

- The SallyBoard is a lightweight patient transfer board
- 3 handles on each side for ease of manoeuvring
- Smooth top surface and curved edges for easy patient transfer
- 4 grip strips on underside to keep board in place
- SallyBoard Curved S.W.L - 130kg when gap is 20 - 30cm. 180kg when gap less than 20cm

Code	Description	Width	Length	Product Weight	S.W.L	DVA:
TSE672195	SallyBoard - Medium	580 mm	1500 mm	3.8 kg	300 kg	AP09
TSE672196	SallyBoard - Large	580 mm	1800 mm	4.6 kg	300 kg	AP09
TSE672191	SallyBoard Curved	222 mm	770 mm	1.4 kg	130 / 180 kg	AP09



## The Slider

- Facilitates sliding patient transfers from wheelchair to car seat, chair, bed etc
- Strong polycarbonate has low friction surface to allow the client to transfer easily
- Reduces strain on user and carer
- Reversible plastic wheel cover designed to fit over the wheel of a wheelchair

Code	Description	Width	Length	S.W.L	DVA:
TSE672800	The Slider - Small	360 mm	540 mm	120 kg	AP09
TSE672790	The Slider - Medium	300 mm	645 mm	120 kg	AP09
TSE672780	The Slider - Large	360 mm	645 mm	120 kg	AP09



## The Slider No Cut Out

- Facilitates sliding patient transfers from wheelchair to car seat, chair, bed etc
- Reduces strain on user and carer
- Ideal for a variety of transfer scenarios
- Strong polycarbonate is low friction surface to allow the client to transfer easily

Code	Description	Width	Length	S.W.L	Warranty	DVA:
TSE672810	The Slider No Cut Out	230 mm	610 mm	80 kg	1 Year	AP09



## Transfer Board Curved

- Facilitates patient transfers from wheelchair to car seat, chair, bed etc
- Two slip resistant pads provide stability during transfer
- Arc shape enables a variety of positioning options and allows for natural sweeping pattern of an assisted transfer

Code	Description	Width	Length	S.W.L	DVA:
TSE672920	Transfer Board Curved	370 mm	710 mm	152 kg	AP09



## Transfer Board Curved Q2

- 285kg weight rating meets the needs of most patients in most transfer situations greatly reducing the risk for healthcare staff
- Unique shape facilitates face-to-face transfers in confined areas
- Two ergonomic handles to easily transport and manoeuvre

Code	Description	Width	Length	S.W.L	DVA:
TSE672192	Transfer Board Curved Q2	338 mm	750 mm	285 kg	AP09



## Aspire Slide Sheet



- Nylon material designed to assist in sliding and transferring patients
- Low friction qualities for ease of transfer
- Folded over and placed under the patient, top sheet slides on lower sheet

Code	Description	Width	Length	DVA:
TSE673070	Slide Sheet - Small	1450 mm	1000 mm	AP09
TSE673080	Slide Sheet - Large	1450 mm	2000 mm	AP09



## Turning Sheet

- The Slide & Turn Sheet makes turning patients in bed much easier
- Log rolling patients is avoided by using the Slide & Turn Sheet
- This special breathable sheet is placed on the bed and stays in position

Code	Description	Width	Length	DVA:
TSE672740	Turning Sheet - Small	1450 mm	1630 mm	AP09
TSE672750	Turning Sheet - Large	1450 mm	1750 mm	AP09



## Roller Sheet

- This heavy duty nylon roller sheet has strong webbing handles on both sides
- Suitable for sliding heavy people in cross-bed and up-bed transfers
- Remains in place under a draw sheet or bed pad

Code	Description	Warranty	DVA:
TSE672510	Roller Sheet	1 Year	AP09

# Transfer & Walk Belts



For NDIS Item Code, refer to page: 508



## Transfer Belt Padded

- Assists the carer in patient mobility and transport, padded for user comfort
- Reduces risk of strain or injury to carer
- Adjustable and with nylon buckle to suit user requirements



## Walk Belt

- Assists the carer in patient mobility and transport
- Reduces risk of strain or injury to carer
- Easily adjustable buckle system and non slip material to increase user safety
- Padded handles for carer comfort

Code	Description	Waist	DVA:
TSE673200	Transfer Belt Padded - Small	750 - 850 mm	AP09
TSE673190	Transfer Belt Padded - Medium	850 - 950 mm	AP09
TSE673180	Transfer Belt Padded - Large	950 - 1050 mm	AP09

Code	Description	Size	DVA:
TSE672040	Walk Belt - Small	630 - 1140 mm	AP09
TSE672030	Walk Belt - Large	1010 - 1570 mm	AP09

Padded handles



## Handi Lift Walk Belt

- A rectangular belt made from a strong lightweight nylon material
- Four padded webbing handles and optional slip resistant lining



## SallyStrap

- SallyStrap is a lightweight strap used to assist patients to stand and walk, especially frail, elderly patients ideal for use at home or in facilities

Code	Description	Wty	DVA:
TSE673000	Handi Lift Walk Belt w/ Miracle Grip - Sml	1 Year	AP09
TSE673120	Handi Lift Walk Belt w/ Miracle Grip - Med	1 Year	AP09
TSE672990	Handi Lift Walk Belt w/ Miracle Grip - Lge	1 Year	AP09
TSE672995	Handi Lift Walk Belt w/ Miracle Grip - XL	1 Year	AP09

Code	Description	Length	Width	S.W.L	Wty	DVA:
TSE672193	SallyStrap - Small	1300 mm	50 mm	150 kg	1 Year	AP09
TSE672194	SallyStrap - Large	1700 mm	50 mm	150 kg	1 Year	AP09

### General Enquiries

P 1300 133 120 | E sales@aidacare.com.au | W www.aidacare.com.au

# Other Transfer Aids

**I ♥ ndis** For NDIS Item Code, refer to page: 508



## Aspire One Way Slide - Non Slip

- Assists in the correct positioning of a person in the back of a chair, prevents them slipping forward
- Reduces the risk of strain or injury from fall or slip
- Helps maintain posture for the user
- Machine washable



## Aspire Swivel Cushion

- Padded rotating seat useful for transfers from wheelchair to car seat etc
- Reduces strain on user and carer backs
- Padded for comfort during transfers and while seated
- Swivel mechanism provides smooth action
- Can also be used on an armless chair



Code	Description	Width	Length	DVA:
TSE673050	One Way Slide - Non Slip	450 mm	440 mm	AP09

Code	Description	Width	DVA:
TSE673056	Swivel Cushion	440 mm	AP09



## Aspire One Way Slide - Non Slip - Foot Operated

- Assists in the correct positioning of a person in the back of a chair, prevents them slipping forward
- Foot strap threads through back of chair for assistance of carer moving patient
- Helps maintain posture for the user
- Machine washable



## Aspire Positioning Slide

- Assists in the correct positioning of a person in the back of a chair
- Foot strap threads through back of chair for assistance of carer moving patient
- Machine washable



Code	Description	Width	Length
TSE673052	One Way Slide - Non Slip - Foot Operated	450 mm	1300 mm

Code	Description	Width	Length
TSE673054	Positioning Slide	460 mm	1375 mm

### DVA Contact Details

P 1300 888 052 | F 1300 787 052 | E [dva@aidacare.com.au](mailto:dva@aidacare.com.au)

**I ♥ ndis** For NDIS Item Code, refer to page: 508

**aidacare**  
HEALTHCARE EQUIPMENT



## Standing Patient Turner - Orbi-turn

- The Orbi-turn has been designed for carers to facilitate standing and seat-to-seat transfers
- It allows a patient with moderate upper and lower limb strength to participate in functional transfers whilst ensuring good working postures for carers and therapists



## Transfer Tube

- Silicone covered slide sheet designed to assist a person move sideways from one continuous surface to another or to swivel on one surface.
- Outer tube coating has slip resistant properties.
- Lightweight and can be folded & carried.

Code	Description	S.W.L	DVA:
TSE672935	Standing Patient Turner - Orbi-turn	190 kg	AP09

Code	Description	Warranty	DVA:
TSE672527	Transfer Tube	1 Year	AP09

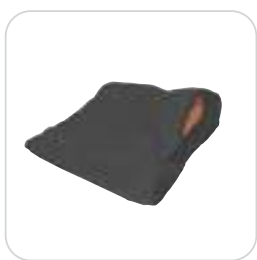

## One Way Seating Aid

- Assists in the correct positioning of a person in the back of a chair, prevents them slipping forward
- Non slip outside cover reduces the need for lap straps
- Reduces the risk of strain or injury from fall or slip
- Helps maintain posture for the user
- Machine washable



## Transfer - Sheet - Slide Sheet Holder/Dispenser

- Designed to store the slide sheet in a convenient place, which can be installed to the wall or stored in a cupboard
- Easy to clean for infection control

Code	Description	Width	Length	DVA:
TSE672520	One Way Seating Aid	450 mm	430 mm	AP09

Code	Description
TSE673060	Transfer - Sheet - Slide Sheet Holder/Dispenser

## Products Associated with Transfer Aids



Aidacare Community Care Bed  
BEB046050  
(Refer to Page 65)



Aspire High Back Day Chair  
CHP208050  
(Refer to Page 109)



Aspire Low Back Day Chair  
CHP208005  
(Refer to Page 112)

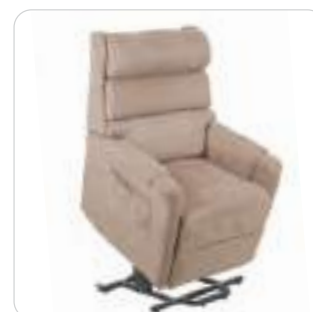

Aspire Signature Lift Recline  
Chair - Space Saver  
CHP197700  
(Refer to Page 116)



Aspire Air Lift Chair  
CHP198865  
(Refer to Page 121)



Aspire Evoke 2 Wheelchair  
- Full Range  
(Refer to Page 273)



Aspire Transit 2 Wheelchair  
- Full Range  
(Refer to Page 275)



# Mobility Scooters

# Contents

- P 225 Mobility Scooters
- P 229 Scooter Selection Guide
- P 230 Scooter Servicing
- P 231 Scooter Accessories





# Mobility Scooters



For NDIS Item Code, refer to page: 508



2x 12V  
12AH

## Go-Go Boot Scooter



- Feather touch disassembly into 5 pieces for easy transportation and storage (refer to image)
- Comfortable front-mounted post seat with arm rests for stability
- Convenient off-board dual voltage charger that can charge battery pack on-board or off-board
- Front basket standard
- Prides exclusive black non-scuffing tyres
- Modular design for easy servicing
- Flat free tyres
- Easy to remove rechargeable battery
- Soft and easy to adjust tiller



Disassembly for transport



Exclusive

SMALL

Code	Description	Length	Width	Max. Speed	Range	Product Weight	S.W.L	Warranty
SCT670613	GoGo Boot Scooter - 4 Wheel	1003 mm	495 mm	6.4 km/h	11.5 km/h	36.6 kg (w/out batteries)	118 kg	2Years (6 months batteries)



2x 12V  
18AH

## Go-Go LX with CTS Scooter



- Go-Go LX with CTS Suspension (Comfort-Trac Suspension) brings a new level of performance and value to travel mobility
- Comfort Track Suspension (CTS) offers users all the benefits of the Go-Go family, but with the comfort of suspension
- Disassembles into 5 pieces for easy transportation and storage (refer to image)
- Easy to remove rechargeable battery
- Soft and easy to adjust tiller
- Includes 3 sets of easily changeable colours (Red, Blue, Silver)
- Lightweight mobility scooter
- Front basket as standard

SMALL

Code	Description	Length	Width	Max. Speed	Range	Product Weight	S.W.L	Warranty
SCT670612	GoGo LX4 Scooter - 4 Wheel	1040 mm	520 mm	6.4 km/h	17 km/h	39.5 kg (w/out batteries)	136 kg	2Years (6 months batteries)

### General Enquiries

P 1300 133 120 | E sales@aidacare.com.au | W www.aidacare.com.au



2 x 12V  
20AH

### Sonic Scooter

- Quickly dismantles into five lightweight pieces for easy transport and storage, no tools required
- Portable and durable scooter
- Puncture-proof tyres
- Detachable battery pack
- Front and rear LED light
- Easy access battery compartment
- Adjustable angle tiller with delta handle
- Optional rearview mirror
- Compact size



Exclusive

SMALL

Code	Description	Length	Width	Max. Speed	Range	Product Weight	S.W.L	Warranty
SCT670665	Sonic Scooter	1040 mm	495 mm	6.8 km/h	20 km	45 kg (with batteries)	136 kg	2 Years (6 months batteries)



1 x 24V  
11.5AH  
Li-Polymer

### Quest Folding Scooter

- Sleek, stylish and extremely easy to operate
- Ready for transport and folded in just 3 easy steps
- Can be stowed upright or laid down
- Sleek, stylish and extremely easy to operate
- Great performance both indoors and out
- Articulated front end adds greater stability
- Front and rear LED headlights



SMALL

Code	Description	Length	Width	Max. Speed	Range	Product Weight	S.W.L	Warranty
SCT670630	Quest Foldable	930 mm	485 mm	6 km/h	20 km	23.5 kg (w/out batteries)	115 kg	2 Years (1 Year batteries)



2 x 12V  
35AH

### GT Scooter

- Offers full advanced suspension for a smoother, more comfortable ride over varied terrain
- Full advanced suspension
- Front and rear LED lighting illuminates your path
- Adjustable delta tiller allows for easy, one-handed operation
- Easy access battery compartment
- Directional signals



Exclusive

MEDIUM

Code	Description	Length	Width	Max. Speed	Range	Product Weight	S.W.L	Warranty
SCT670670	GT Scooter	1200 mm	605 mm	10 km/h	30 km	82 kg (with batteries)	159 kg	2 Years (6 months batteries)



2x 12V  
31AH  
(40AH Optional)

### Pathrider 10 Scooter

- High performance, sleek and sporty mobility scooter
- Low profile, puncture proof tyres
- Back lit battery gauge
- Eight-position seat rotation
- Comfortable front-mounted post seat with armrests for stability
- Wrap around easy drive tiller
- Front basket as standard



MEDIUM

Code	Description	Length	Width	Max. Speed	Range	Product Weight	S.W.L	Warranty	DVA:
SCT670615	Pathrider 10	1190 mm	565 mm	Up to 8.5 km/h	21 km	63.5 kg (w/out batteries)	158 kg	2 Years (1 Year batteries)	AP05



## Patrioter 10 DX Scooter

- High performance sleek and sporty mobility scooter
- Low profile, puncture proof tyres
- Comfortable front-mounted post seat with armrests for stability
- Back-lit battery gauge on monitor
- Rugged front and rear suspension
- Long lasting high intensity LED headlight, tail light and indicators
- Wrap around easy drive tiller



**MEDIUM**

Code	Description	Length	Width	Max. Speed	Range	Product Weight	S.W.L	Warranty	DVA:
SCT670620	Patrioter 10 DX	1193 mm	565 mm	Up to 9 km/h	21 km	85 kg (w/out batteries)	158 kg	2Years (1Year batteries)	AP05



## Victory 10 LX Scooter

- A sporty, sleek outdoor scooter
- Full digital displaying speedometer/odometer
- Large rear storage pod included as standard
- Full suspension system
- Powerful front/rear lighting kit
- High back, adjustable seat



**MEDIUM**

Code	Description	Length	Width	Max. Speed	Range	Product Weight	S.W.L	Warranty	DVA:
SCT670640	Victory 10 LX Scooter - 4 Wheel Red	1194 mm	565 mm	9 km/h	26 km	71 kg (w/out batteries)	181 kg	2Years (1Year batteries)	AP05



## Patrioter 130 XL Pursuit Scooter

- Large 33 cm (13") pneumatic tyres for excellent outdoor performance
- Full lighting package including directional signals and angle adjustable
- LED headlight
- Easy drive tiller with wrap around handles
- Front basket standard, rear storage bag
- Easily accessible tie down points (for transport of unoccupied scooter)
- Front and rear suspension handle rugged outdoor terrain
- Rearview mirror standard



**Exclusive**

**LARGE**

Code	Description	Length	Width	Max. Speed	Range	Product Weight	S.W.L	Warranty	DVA:
SCT670571	Patrioter 130XL Pursuit - Red	1359 mm	635 mm	12.4 km/h	Up to 25 km/h	73 kg (w/out batteries)	159 kg	2Years (1Year batteries)	AP05



## Patrioter 140 XL Scooter

- Top of the range sleek and sporty powered mobility scooter
- Large 13" pneumatic tyres to handle rugged outdoor terrain
- Tiller mounted battery charger port for off board charger
- Including directional adjustment. Long lasting high intensity LED kerb light, headlight, tail light and indicators
- Wrap around easy drive tiller
- Back lit battery gauge
- Automatic full lighting system
- Luxurious suspension seat with armrests, head rest and lumbar support for stability
- Rugged front and rear suspension and sealed hydraulic brakes



**LARGE**

Code	Description	Length	Width	Max. Speed	Range	Product Weight	S.W.L	Warranty	DVA:
SCT670578	Patrioter 140XL - Yellow	1428 mm	692 mm	10 km/h	35 km	118 kg (w/out batteries)	181 kg	2 Years (1 Year batteries)	-
SCT670576	Patrioter 140XL - Red	1428 mm	692 mm	10 km/h	35 km	118 kg (w/out batteries)	181 kg	2 Years (1 Year batteries)	AP05
SCT670577	Patrioter 140XL - Silver	1428 mm	692 mm	10 km/h	35 km	118 kg (w/out batteries)	181 kg	2 Years (1 Year batteries)	-

Mobility Scooters



## Celebrity Deluxe XL Scooter



- High performance mobility scooter
- Large knobby tyres for excellent outdoor traction
- Unique easily adjusted steering mount with modern LED lighting
- Rear view mirror and full directional lighting package including front and rear turn signal indicators
- State of the art rear suspension
- Deluxe front-mounted high back swivel seat with headrest and armrests for stability
- Lumbar support and manual recline for increased comfort
- Front basket as standard

LARGE

Code	Description	Length	Width	Max. Speed	Range	Product Weight	S.W.L	Warranty	DVA:
SCT670540	Celebrity Deluxe XL - Red	1300 mm	640 mm	10 km/h	40 km	91 kg (w/out batteries)	181 kg	2Years (1Year batteries)	AP05



## Sportrider Scooter



- A sporty, sleek outdoor scooter
- Full digital displaying speedometer/odometer
- Large rear storage pod included as standard
- Powerful front/rear lighting kit
- High back, adjustable seat
- Full suspension system

LARGE

Code	Description	Length	Width	Max. Speed	Range	Product Weight	S.W.L	Warranty
SCT670585	Sportrider XL	1650 mm	780 mm	Up to 12 km/h	50 km	120.5 kg (w/out batteries)	181 kg	2Years (1Year batteries)

## Product & Training Video Resources

Aidacare have an extensive free-to-use video library containing Mobility Scooter safe use videos.

All of these are available at [www.aidacare.com.au/knowledge/videos](http://www.aidacare.com.au/knowledge/videos)

For more information, please contact your local Aidacare representative or call **1300 133 120**.



Pride Sonic & GT Mobility Scooters

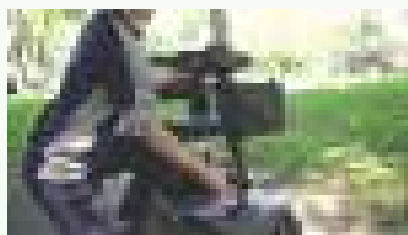

Pride Sportsrider

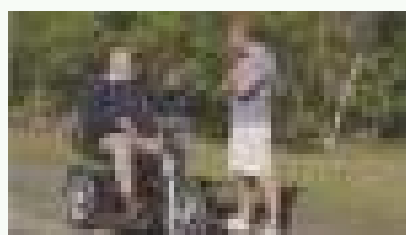

Pride GoGo Boot Scooter



Pride Quest Mobility Scooter



Pride Scooters 'Versatility'

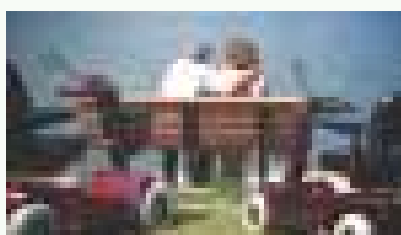



### Pride Scooter Selection Guide

#### SCOOTER RANGE OVERVIEW

				
<b>Model</b>	<b>GoGo Boot Scooter</b>	<b>GoGo LX with CTS Scooter</b>	<b>Sonic Scooter</b>	<b>Quest Folding Compact</b>
<b>Size</b>	<b>*Small*</b>	<b>*Small*</b>	<b>*Small*</b>	<b>*Small*</b>
<b>Code</b>	SCT670613	SCT670612	SCT670665	SCT670630
<b>Range (Max.)</b>	11.5 km	17 km	20 km	20 km
<b>Battery</b>	2 x 12V 12AH	2 x 12V 18AH	2 x 12V 20AH	1 x 24V 11.5AH Li-Polymer
<b>Seat Type</b>	Low back	Low back	Low Back	Low back
<b>Max Weight</b>	118 kg	136 kg	136 kg	115 kg
<b>Std Body Colours</b>	Red	Red	Red	White
<b>Features</b>	Lightweight, <b>disassembles</b> , dual-voltage charger, adjustable tiller, flat free tyres, front basket	Lightweight, <b>disassembles</b> , comfort track suspension (CTS), adjustable tiller, front basket	Lightweight, <b>disassembles</b> , LED light, adjustable tiller and delta handle	Lightweight <b>Folding</b> design, folds in three easy steps, adjustable tiller

#### SCOOTER RANGE OVERVIEW

				
<b>Model</b>	<b>GT Scooter</b>	<b>Pathrider 10 Scooter</b>	<b>Pathrider 10 DX Scooter</b>	<b>Victory 10 LX Scooter</b>
<b>Size</b>	<b>**Medium**</b>	<b>**Medium**</b>	<b>**Medium**</b>	<b>**Medium**</b>
<b>Code</b>	SCT670670	SCT670615	SCT670620	SCT670640
<b>Range (Max.)</b>	30 km	40 km	33 km	26 km
<b>Battery</b>	2 x 12V 35AH	2x 12V 31AH (40AH optional)	2x 12V 31AH (40AH optional)	2 x 12V 40AH
<b>Seat Type</b>	Low Back	Low back	High back	High back
<b>Max Weight (S.W.L)</b>	159 kg	159 kg	159 kg	181 kg
<b>Std Body Colours</b>	Red	Viper Blue	Viper Blue	Blue
<b>Features</b>	Advanced suspension, LED light, deluxe tiller, directional signals	High performance, sporty, flat free tyres, back lit battery gauge, armrests, front basket	High performance, sporty, flat free tyres, head & armrests, front & rear suspension	Sporty, outdoor use, digital display speedometer/odometer. Full suspension, front/rear lighting kit

#### SCOOTER RANGE OVERVIEW

				
<b>Model</b>	<b>Pathrider 130 XL Pursuit Scooter</b>	<b>Pathrider 140 XL Scooter</b>	<b>Celebrity Deluxe XL Scooter</b>	<b>Sportrider Scooter</b>
<b>Size</b>	<b>***Large***</b>	<b>***Large***</b>	<b>***Large***</b>	<b>***Large***</b>
<b>Code</b>	SCT670571	SCT670576	SCT670540	SCT670585
<b>Range (Max.)</b>	25 km	35 km	40 km	50 km
<b>Battery</b>	2 x 12V 55AH	2 x 12V 70AH	2 x 12V 40AH	2 x 12V 70AH
<b>Seat Type</b>	CRS Deluxe	Deluxe Captains Seat	Deluxe reclining high back	High back, adjustable
<b>Max Weight</b>	159 kg	181 kg	181 kg	181 kg
<b>Std Body Colours</b>	Candy Apple Red	Candy Apple Red, Silver & Yellow	Candy Apple Red & Silver	Silver
<b>Features</b>	High performance, sporty, large pneumatic tyres, head & armrests, full lighting package	Top of range sporty, large pneumatic tyres for outdoor, head & armrests, front & rear suspension	High performance, large tyres for outdoor, head & armrests, lumbar support, rear suspension	Sleek outdoor scooter, digital speedometer display, full suspension system, front/rear lighting



**'KEEP YOUR  
SCOOTER SCOOTING'  
BOOK AN ANNUAL SERVICE**



WE RECOMMEND  
YOU SERVICE YOUR  
SCOOTER EVERY  
**12 MONTHS**

## Scooter Servicing

Our team of trained service technicians are on hand to perform a full service on your scooter.

Our team are authorised Pride agents so you can be sure only quality parts will be used and your warranty will be retained.

Call us today to book your scooter in.

**THE AIDACARE SERVICE DEPARTMENT STOCK A  
FULL RANGE OF SPARE SCOOTER PARTS.**

Batteries & Chargers		O = Optional											
Code	Description	GOGO Boot	GOGO LX	Sonic	Quest Folding	GT	Pathrider 10	Pathrider 10 DX	Victory 10 LX	Pathrider 130 XL Pursuit	Pathrider 140 XL	Celebrity DX XL	Sportrider
MBT403100	Battery 24V - 11.5 AH Li-Polymer				✓								
MBT401470	Battery 12V - 12 AH	✓											
MBT401480	Battery 12V - 18 AH		✓	✓									
MBT401300	Battery 12V - 31 AH <i>(DVA Approved AP02)</i>					✓	✓	✓					
MBT401290	Battery 12V - 40 AH <i>(DVA Approved AP02)</i>						O	O	✓			✓	
MBT401250	Battery 12V - 55 AH <i>(DVA Approved AP02)</i>									✓	✓		
MBT401260	Battery 12V - 70 AH <i>(DVA Approved AP02)</i>									O	O		✓
MBT403105	Battery Charger 3 Amp Li-Polymer				✓								
MBT401575	Battery Charger 3 Amp	✓	✓	✓									
MBT401580	Battery Charger 4 Amp					✓	✓	✓	✓			✓	
MBT401590	Battery Charger 8 Amp										✓		✓
Tyres & Tubes		GOGO Boot	GOGO LX	Sonic	Quest Folding	GT	Pathrider 10	Pathrider 10 DX	Victory 10 LX	Pathrider 130 XL Pursuit	Pathrider 140 XL	Celebrity DX XL	Sportrider
MWT450189	Tyre - 400 x 8 - Pneumatic								✓	✓	✓		
MWT450599	Tube - 400 x 8								✓	✓	✓		
MWT450150	Tyre - 4.10/3.5 x 6											✓	
MWT450690	Tube - 4.10/3.5 x 6											✓	
MWT471216	Wheel - Front - Solid						✓	✓					
MWT471217	Wheel - Rear - Solid						✓	✓					
							<p><i>For These Models Please Contact Your Local Aidacare Service Team</i></p>						
													<p><i>Please Contact Your Local Aidacare Service Team</i></p>



# Scooter Accessories



For NDIS Item Code, refer to page: 508



## Wind/Rain Shield

- Protects the scooter driver from the wind and rain whilst driving
- Aluminium frame attaches to the bumper bar and the sun canopy, comes with clear front shield
- Please specify type of scooter at time of order
- Used in conjunction with sun canopy
- Note: pictured with optional side wind shields (2 x SCA668395) and rear wind shield (SCA668396)
- Note: pictured with sun canopy which must be used for attachment (SCA668380)

Code	Description
SCA668392	Rain Cover for Scooter
SCA668397	Scooter Wind/Rain Shield Front Section Including Frame
SCA668396	Scooter Rear Wind Shield
SCA668395	Scooter Side Wind Shield (each)



Please note: Picture shows Cane Holder Single Rear

## Cane Holder

- Scooter mounted walking stick holder
- Mounts directly onto the scooter tow bar (or side option)
- Also available in side mounted and flag holding version
- Both options come in either single or double

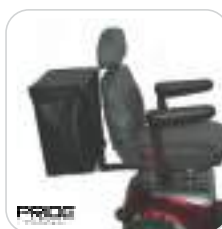

## Scooter Rear Bag

- Attachment to carry bits and pieces
- Fits into the scooter tow bar on the rear
- Durable black tonneau material
- Comes with all mounting hardware required for installation (including L Piece Accessory)

Code	Description	DVA:
SCA668230	Cane Holder Single Rear	AP14
SCA668220	Cane Holder Double Rear	AP14
SCA668240	Cane Holder Double Side	AP14
SCA668250	Cane Holder Single Side	AP14

Code	Description	DVA:
SCA668340	Scooter Rear Bag	AP14
SCA668350	Crossbar With Fork For Bag	AP14
SCA668360	Black Replacement Rear Bag	AP14

SCA668240/ SCA668250 Both requires additional L Piece accessory (SCA668310)



## Mirror - Celebrity & Pathrider

- Round rearview mirror assembly for select Pride scooter models
- Includes review mirror, top bracket, bottom bracket and hardware (nuts and screws)



## Oxygen Bottle Holder

- Scooter mounted oxygen bottle holder
- Carries a 406L oxygen bottle
- Fits into the scooter tow bar on the rear
- Can be used in conjunction with the cane holder mount
- If by itself, requires the "L" Piece Accessory (SCA668310)

Code	Description	DVA:
SCA668300	Mirror - Celebrity & Pathrider	AP14

Code	Description	DVA:
SCA668330	Oxygen Bottle Holder	AP14

### General Enquiries

P 1300 133 120 | E sales@aidacare.com.au | W www.aidacare.com.au



### Scooter Flag

- A long flexible flag to provide increased visibility to a scooter

Code	Description	DVA:
SCA668370	Scooter Flag	AP14



### Cup Holder

- Accessory to suit all three & four wheel scooters

Code	Description
SCA668170	Cup Holder



### Dust Cover

- Strong and lightweight dust cover
- Ideal for protecting your scooter whilst not in use
- Not recommended for use as a rain cover

Code	Description
SCA668210	Dust Cover for Scooter



### Golf Bag Carrier

- The golf bag carrier will accommodate one golf bag and it attaches to the universal accessory holder on the back of your Pride scooter

Code	Description
SCA668280	Golf Bag Carrier



### Rear Basket

- Handy rear storage basket, ideal for your handbag/groceries

Code	Description	DVA:
SCA668180	Rear Basket	AP14



### L Piece Accessory

- Scooter accessory mounting equipment
- Designed for use with the following scooter accessories

Code	Description	DVA:
SCA668310	L Piece Accessory	AP14



### Walking Frame Holder

- Scooter mounted walking frame holder
- Mounts directly onto the scooter tow bar
- Can be used in with the sun canopy
- If by itself, requires the "L" Piece Accessory (SCA668310) and anti-rattle clamp (SCA668312)

Code	Description	DVA:
SCA668390	Walking Frame Holder	AP14



### Sun Canopy

- Large scooter canopy great for sun or rain protection - 600mm wide x 700mm long
- Fits into the scooter tow bar on the rear
- Sturdy waterproof canvas
- Comes with all mounting hardware required for installation

Code	Description	DVA:
SCA668380	Sun Canopy	AP14



### Saddlebag

- Allows users to carry essential belongings within their reach

Code	Description
SCA668398	Saddlebag



### Rear Pod

- Aids users to carry belongings in a sturdy rear case
- Designed for larger scooter models
- Key locked for extra security

Code	Description
SCA668399	Rear Pod



## MobilityHQ

Visit Online for the Best Prices on Mobility Scooters





CONTACT US  
FOR A PROGRAM

# AIDACARE'S PROFESSIONAL TRAINING PROGRAM

Earn  
CPD  
Hours

The Aidacare Professional Training (APT) is a national program that offers all healthcare providers, such as Allied Health Clinicians, Nurses, Case Managers, Carers and Medical Professionals the most up-to-date educational training.

This is a great opportunity to build up your CPD (Continuing Professional Development) hours which Occupational Therapists and Physiotherapists need for the renewal of their registration each year.

All Seminars and training sessions are live online via Eventbrite so visit our page to see all available sessions!

[www.aidacare.eventbrite.com.au](http://www.aidacare.eventbrite.com.au)



Aidacare Professional Training skills for your career



Book your seat today at  
[www.aidacare.eventbrite.com.au](http://www.aidacare.eventbrite.com.au)

# Paediatric

# Contents

- P 240 Strollers & Walking Frames
- P 243 Seating & Standing Aids
- P 248 Paediatric Cots
- P 250 Other Paediatric



# Strollers & Walking Frames



For NDIS Item Code, refer to page: 508



## Kimba Neo Stroller

**ottobock.**

- Indoor or outdoor stroller for children requiring postural support
- Built-in suspension ensures a smooth ride outdoors
- Easy-to-use, unique folding system for easy transportation or storage
- Includes height-adjustable push handle, angle-adjustable backrest plus tilt-in-space
- A number of seating support accessories available



Code	Description	Seat Width	Seat Depth	Back Height	Seat to Footrest	S.W.L	Warranty
PED478438	Kimba Neo Stroller, Size 1, Ages 1 - 6 years	200 - 300 mm	190 - 310 mm	410 - 610 mm	190 - 310 mm	40 kg	2 Years
PED478439	Kimba Neo Stroller, Size 2, Ages 4 - 10 years	260 - 350 mm	240 - 400 mm	570 - 700 mm	200 - 370 mm	40 kg	2 Years



## Kidwalk

**ottobock.**

- Partially weight bearing, posturally supportive mobility system which encourages mobility and moves with the child
- Easy, tool-free set-up and adjustment
- Child walks unaided while also keeping hands free
- Available in 2 sizes



Code	Description	Overall Width	Overall Length	Height of User	S.W.L	Warranty
PED479355	Kidwalk, Size 1, Ages 1 - 7 Years	640 mm	825 - 875 mm	610 - 1220 mm	30 kg	2 Years
PED479356	Kidwalk, Size 2, Ages 5 - 12 Years	700 mm	900 - 950 mm	1010 - 1520 mm	40 kg	2 Years

General Enquiries

P 1300 133 120 | E sales@aidacare.com.au | W www.aidacare.com.au



## Nimbo Lightweight Walking Aid

- Lightweight aluminium frame
- Tool free height adjustment
- Soft rubber wheels adhere to any surface and prevent Nimbo from sliding backwards
- One directional rear wheels with aluminium ratchet and pin mechanism
- Latex free handles with flanged ends
- Folds easily for convenient storage and transportation
- Available in 5 sizes - Specify size on request
- Accessories available on request

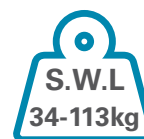

Code	Description	Overall Width	Overall Length	Product Weight	S.W.L	Warranty
PED480800	Nimbo Walking Aid (Specify size)	610 - 740 mm	510 - 940 mm	4 - 7 kg	34 - 113 kg	2 Years
PED480810	Nimbo Seat					2 Years



## Trekker Gait Trainer

- Cardiopulmonary strengthening and conditioning
- Reduces flexion contractures to enhance movement
- Increases spatial awareness and head control to achieve independent ambulation
- Teaches individual to take steps without assistance
- Can be used in the anterior and posterior position providing flexibility for the user
- Directional lever allows both forward and reverse mobility or only forward mobility
- Available in 2 sizes - Specify size on request
- Accessories available on request



Code	Description	Seat Width	Seat Depth	Height	S.W.L	Warranty
PED480820	Trekker Gait Trainer	620 - 670 mm	790 - 940 mm	530 - 990 mm	68 - 90 kg	2 Years



## Nurmi Neo Walking Aid

**ottobock.**

- Innovative walking aid for children
- Positioned behind the child's body whilst walking allowing open directional walking
- Lightweight folding frame is height adjustable to grow with the user
- Includes reverse roll locks and swivelling front castors
- Options available to customise the frame to the individual user
- Available in 3 sizes



Code	Description	Overall Width	Overall Length	Product Weight	S.W.L	Warranty
PED479349	Nurmi Neo Walking Aid - Size 1	630 mm	650 mm	5.5 kg	25 kg	2 Years
PED479350	Nurmi Neo Walking Aid - Size 2	680 mm	760 mm	6 kg	40 kg	2 Years
PED479351	Nurmi Neo Walking Aid - Size 3	720 mm	830 mm	6.5 kg	55 kg	2 Years



## EZ Rider

**Convaid**

- Ultra lightweight compact folding stroller
- 10 degree seat tilt allows correct positioning for children needing postural support, but also keeps them sitting upright
- Seating accessories include headrests, torso supports and tray
- Available as crash tested Bus Transport model
- Bus Transport model comes standard with tie-down system, H-Harness, headrest extension, and foot straps
- Available in 4 different seat widths



Code	Description	Seat Width	Seat Depth	Back Height	Seat to Footrest	Product Weight	S.W.L	Warranty
PED477700	EZ Rider	305 - 455 mm	229 - 495 mm	451 - 508 mm	76 - 559 mm	11.4 - 13.2 kg	30 - 77 kg	Limited Lifetime



## Cruiser

Convald

- Lightweight compact folding stroller
- Set at 30 degrees seat tilt to allow for more postural support
- Seating accessories include headrests, torso supports and tray
- Available as crash tested Bus Transport model
- Bus Transport model comes standard with tie-down system, H-Harness, headrest extension, and foot straps
- Available in 5 different seat widths



Code	Description	Seat Width	Seat Depth	Back Height	Seat to Footrest	Product Weight	S.W.L	Warranty
PED477260	Cruiser	255 - 455 mm	152 - 533 mm	533 - 630 mm	130 - 580 mm	8.6 - 13.6 kg	30 - 77 kg	Limited Lifetime



## Rodeo Tilt

Convald

- Versatile Tilt-In-Space stroller
- Compact folding and lightweight design for easy transporting
- Available as crash tested Bus Transport model
- Available in 4 different seat widths
- Bus Transport model comes standard with tie-down system, H-Harness, headrest extension, and foot straps



Code	Description	Seat Width	Seat Depth	Back Height	Seat to Footrest	Product Weight	S.W.L	Warranty
PED478195	Rodeo Tilt	255 - 405 mm	178 - 457 mm	533 - 635 mm	230 - 457 mm	13.2 - 17.7 kg	30 - 63.6 kg	Limited Lifetime



## WeGo



- WeGo has a higher weight capacity than most pushchairs. It carries kids up to 30kg
- It reclines to 140°, so your child can lie back for a little snooze or to be changed and they'll still have the support of the GoTo Seat
- Easily fit your GoTo seat in the seat
- Comes with a full accessory pack, including a sun canopy, rain cover, cup holder, mosquito net and foot muff



Code	Description	WeGo Height	WeGo Weight	Seat Depth	Seat Height	Seat Width	Footprint Length	Footprint Height	Footrest Shortest Setting	Footrest Longest Setting	S.W.L
PED491200	WeGo - Push Chair with full accessories pack	1120 mm	110 mm	260 mm	500 mm	350 mm	1160 mm	380 mm	250 mm	330 mm	30 kg

### General Enquiries

P 1300 133 120 | E sales@aidacare.com.au | W www.aidacare.com.au



# Seating & Standing Aids



For NDIS Item Code, refer to page: 508



## Totstander

- The Totstander promotes active standing movement and weight shifting
- Available with adjustable pelvic belt, chest strap, knee cups and sandals
- Highly portable

- Often used as an assessment tool by therapists

LECKEY<sup>o</sup>



Code	Description	User Standing Height	Chest Pad Height	S.W.L	Warranty
PED479240	Totstander, Ages 1 - 5 years	750 - 900 mm	470 - 640 mm	22 kg	2Years



## Squiggles Standing System

- Squiggles Standing System supports the child in a comfortable, secure, prone, supine or upright standing posture
- Chassis can clip on and off in seconds for folding and storage
- Adjustable to accommodate children with differing needs

- Accessories available include tray, knee blocks, supports, headrests which all attach without tools

LECKEY<sup>o</sup>



Code	Description	User Standing Height	Chest Pad Height	S.W.L	Warranty
PED479379	Squiggles Stander, Ages 1 - 5 years	750 - 1100 mm	550 - 820 mm	22 kg	2 Years



## Squiggles+ Stander

- Hip abduction of up to 60° in prone, upright and supine standing.
- Fully horizontal loading in supine.
- New, improved, pivot chassis.
- New wrap around knee supports to better accommodate all sizes, with added comfort & support.

- Height-adjustable, foldable push handle for ergonomic use.
- Individually adjustable footplates to accommodate leg length discrepancy.

LECKEY<sup>o</sup>



Code	Description	User Standing Height	Chest Pad Height	S.W.L	Wty
PED479380	Squiggles+ Stander, Ages 1 - 5 years	750 - 1110 mm	550 - 820 mm	22 kg	2Years

### DVA Contact Details

P 1300 888 052 | F 1300 787 052 | E [dva@aidacare.com.au](mailto:dva@aidacare.com.au)



For NDIS Item Code, refer to page: 508





### Pronestander

- The Pronestander is a stander with a choice of 5 prone positions ranging from 45° to 85°
- Assists in standing and weight bearing
- Highly adjustable to suit individual users
- Includes chest and knee supports, hip belt, angle adjustable tray, activity bowl and a mobility base with 4 locking castors for stability

**LECKEY**°



Code	Description	User Standing Height	Chest Pad Height	S.W.L	Warranty
PED479250	Pronestander, Ages 1.5 - 5 years	800 - 1150 mm	470 - 680 mm	60 kg	2 Years
PED479260	Pronestander, Ages 4 - 10 years	1100 - 1450 mm	680 - 975 mm	80 kg	2 Years
PED479270	Pronestander, Ages 9 - 18 years	1400 - 1850 mm	975 - 1350 mm	90 kg	2 Years



### Freestander

- The Freestander is a robust upright stander ideally suited to the classroom, therapy room or home
- Designed to assist in standing and weight bearing development
- Highly adjustable to suit individual users
- Includes chest and knee supports, hip belt, angle adjustable tray, activity bowl and a mobility base with 4 locking castors for stability

**LECKEY**°



Code	Description	User Standing Height	Chest Pad Height	S.W.L	Warranty
PED479170	Freestander, Ages 1.5 - 5 years	800 - 1151 mm	470 - 680 mm	60 kg	2 Years
PED479180	Freestander, Ages 4 - 10 years	1100 - 1448 mm	680 - 975 mm	80 kg	2 Years
PED479190	Freestander, Ages 9 - 18 years	1400 - 1849 mm	975 - 1350 mm	90 kg	2 Years



### Horizon

- The Horizon is a durable 3-in-1 stander which can be positioned in prone, supine or upright
- Changeable from prone, supine or upright setups
- Fully adjustable to suit the individual user and is ideal in multi user environments
- Available with headrest, adjustable sandals, lateral supports and pelvic positioning belt

**LECKEY**°



Code	Description	User Standing Height	Chest Pad Height	S.W.L	Warranty
PED479105	Horizon, Ages 4 - 10 years	1000 - 1400 mm	820 - 1150 mm	50 kg	2 Years
PED479130	Horizon, Ages 9 - 18 years	1400 - 1800 mm	1000 - 1450 mm	80 kg	2 Years
PED479135	Horizon, Ages 14 years - adult	1550 - 1800 mm	1000 - 1450 mm	100kg	2 Years



### PAL Classroom Seat

- Attractive, robust and easy to use classroom and nursery seating system for kids with mild to moderate postural needs
- Matching tables available
- Improves stability, reduces fatigue and allows the child longer periods of concentration and fine motor activity

**LECKEY**°



Code	Description	Seat Width	Seat Depth	Backrest Height	S.W.L	Wty
PED478800	PAL Classroom Seat, Size 1, Ages 1 - 3 years	150 - 250 mm	180 - 240 mm	265 mm	30 kg	2 Years
PED478802	PAL Classroom Seat, Size 2, Ages 2 - 5 years	170 - 270 mm	220 - 290 mm	315 mm	35 kg	2 Years
PED478804	PAL Classroom Seat, Size 3, Ages 4 - 8 years	230 - 330 mm	250 - 330 mm	380 mm	40 kg	2 Years
PED478806	PAL Classroom Seat, Size 4, Ages 7 - 12 years	280 - 380 mm	300 - 400 mm	450 mm	50 kg	2 Years



### MyWay Walking Aid

- Open frame design enables children to touch, feel, learn and play at their own pace
- MyWay castors are multifunctional to assist children with their individual needs
- Can be fine tuned to achieve the optimum position for mobility for each child
- Open frame also allows therapists to work closely with the child on their lower limbs for therapeutic benefits
- Frame is foldable, facilitating convenient storage and transportation

**LECKEY**°



Code	Description	User Standing Height	Seat Height	S.W.L	Wty
PED479385	MyWay Walking Aid - Size 1, Ages 1 - 5 years	635 - 920 mm	220 - 440 mm	25 kg	2 Years
PED479386	MyWay Walking Aid - Size 2, Ages 4 - 11 years	870 - 1190 mm	400 - 610 mm	50 kg	2 Years
PED479387	MyWay Walking Aid - Size 3, Ages 9 - 16 years	1070 - 1490 mm	550 - 810 mm	80 kg	2 Years



## Squiggles Seating System

- Squiggles Seating System is designed for younger children requiring postural support
- Adjustable seating system with tilt in space mechanism
- Designed to suit children from 1 to 5 years and allows for growth
- Can be ordered with a choice of base including wheelchair base, stroller base or high low indoor base
- Seating accessories include thoracic supports, sandals, tray, harness plus others
- Seating system fits a number of transporting systems



Code	Description	Seat Width	Seat Depth	Backrest Height	S.W.L	Warranty
PED479369	Squiggles Seating System, Ages 1 - 5 years	160 - 260 mm	190 - 290 mm	320 - 380 mm	22 kg	2 Years



## Mygo Seating System

- Multifunctional seating system designed for children and adolescents requiring moderate to complex postural support
- Includes leg guides, four-point pelvic positioning harness and adjustable sacral support
- Available with unique Leckey pelvic cradle for improved postural control
- Seat width and depth are continuously adjustable allowing for a large degree of growth
- Range of additional postural supports available
- Seating system fits a number of transporting systems



Code	Description	Seat Width	Seat Depth	Backrest Height	S.W.L	Wty
PED479339	Mygo S/System, Size 1, Ages 3 - 10 years	200 - 325 mm	270 - 420 mm	360 - 470 mm	50 kg	2 Years
PED479338	Mygo S/System, Size 2, Ages 8 - 14 years	220 - 345 mm	350 - 470 mm	460 - 570 mm	60 kg	2 Years



## Early Activity System

- Designed to help with physical, cognitive and sensory development for babies with special needs
- System supplied as a "kit" to support a young child to sit, lie on their tummy, back or side
- Can be used by therapists as well as parents
- Designed to suit children up to 3

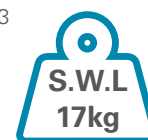

Code	Description	Seat Depth	Hip Width	Backrest Height	S.W.L	Warranty
PED480100	Early Activity System	190 - 260 mm	150 - 200 mm	100 mm	17 kg	2 Years



## Mygo Stander

- The Mygo Stander provides a 3-in-1 prone, supine and upright standing positions
- Comes with height adjustable chest pad that is ergonomically designed to imitate the shape of the rib cage
- Includes hip support, chest support, 4 castors with brakes and height adjustable footplates and knee supports



Code	Description	Overall Width	Overall Length	Chest Width	Hip Width	Height of User Range	S.W.L	Wty
PED479335	Mygo Stander, Size 1, Ages 4 - 10 years	630 mm	978 mm	160 - 280 mm	220 - 330 mm	1080 - 1450 mm	50 kg	2 Years
PED479336	Mygo Stander, Size 2, Ages 8 - 14 years	650 mm	1130 mm	200 - 320 mm	280 - 390 mm	1350 - 1750 mm	60 kg	2 Years





### GoTo Size 1

- Adjustable Head Supports - Pick a standard headrest for simple contoured comfort or the advanced headrest which offers more sculpted support
- Adjustable Laterals - The laterals move high, low, wide or narrow to give a reassuring 'hug', while the head support slides up and down to the ideal height
- Optional Floorsitter - The new and improved Floorsitter has 26 recline positions. It's ideal for finding the exact level of support your little one needs for playtime or a power nap
- Optional Pressure Cushion



Code	Description	Size	Seat base to top of headrest Max / Min	Lateral support width Max / Min	Seat Depth	Age Range	S.W.L
PED490500	GoTo Seat - Advanced Headrest - Light Blue / Dark Blue	Size 1	540 mm MAX 380 mm MIN	260 mm MAX 190 mm MIN	175 mm	1-3 Years	15 kg



### GoTo Size 2

- Adjustable Head Supports - Pick a standard headrest for simple contoured comfort or the advanced headrest which offers more sculpted support
- Adjustable Laterals - The laterals move high, low, wide or narrow to give a reassuring 'hug', while the head support slides up and down to the ideal height
- Optional Floorsitter - The new and improved Floorsitter has 26 recline positions. It's ideal for finding the exact level of support your little one needs for playtime or a power nap
- Optional Pressure Cushion



Code	Description	Size	Seat base to top of headrest Max / Min	Lateral support width Max / Min	Seat Depth	Age Range	S.W.L
PED490600	GoTo Size 2 - Advanced Headrest - Light Blue / Dark Blue with Floorsitter & cushion	Size 2	680 mm MAX 510 mm MIN	300 mm MAX 210 mm MIN	244 mm	3-8 Years	30 kg
PED490610	GoTo Size 2 - Advanced Headrest - Pink / Purple with Floorsitter & cushion	Size 2	680 mm MAX 510 mm MIN	300 mm MAX 210 mm MIN	244 mm	3-8 Years	30 kg



### Scoot 4 in 1

- Scooter Backrest - Our improved higher backrest provides kids with more support and reduces the amount of trunk control needed to use Scoot
- Push pole aids the child to propel themselves out of the chair
- Footplates & Wheels - Scoot's durable and easily gripped rubber tyres make it suitable for outdoor use. The footplate can be easily adjusted to your child's exact leg length
- Advanced Backrest Cushion - The laterals move up and down to give support where it's needed
- Backrest Cushion Lateral Length - 790mm MIN - 1010mm MAX
- Push Pole Height: H 800mm MIN - H 890mm MAX



Code	Description	Backrest width	Backrest height	Seat Base Width	Wheel Arch Width	Hip to end of footplate when seated	Backrest Cushion Laterals Length	Age Range	S.W.L
PED490900	Scoot 4 in 1 with Advanced backrest	260 mm	300 mm	230 mm	230 mm	520 mm (not extended) 630 mm (fully extended)	420 mm	2-6 Years	22 kg

#### General Enquiries

P 1300 133 120 | E sales@aidacare.com.au | W www.aidacare.com.au



## Upsee

- Creates the possibility of social and emotional development by letting children interact with their peers at eye-level
- Upsee can be used to work on a variety of mobility and ability skills, from weight-bearing and walking to improving head control
- When your child is motivated to explore and move and weight-bear, it creates a real possibility for long-term development



Code	Description
PED490700	Upsee (Therapist Kit) - The Upsee kit is made up of three parts: an adult hip-belt, a child harness and shared sandals



## Playpak

- The various supports allow you to achieve an even wider variety of developmental postures and positions such as; tummy lying, floor sitting, back lying and 4-point kneeling
- Playpak is light, handy and can go anywhere
- Therapeutic and early intervention strategies allow your babies and children to develop healthy habits



Code	Description	Length	Width	Depth
PED490600	Folded Bag	440 mm	490 mm	150 mm
	Floor Mat	1340 mm	750 mm	-
	Long Roll	520 mm	90 mm	70 mm
	Short Roll	280 mm	90 mm	70 mm
	Positioning Strap	660 mm	80 mm	-
	Large Horseshoe	440 mm	490 mm	150 mm
	Small Horseshoe	70 mm	90 mm	200 mm



### DVA Contact Details

P 1300 888 052 | F 1300 787 052 | E [dva@aidacare.com.au](mailto:dva@aidacare.com.au)



For NDIS Item Code, refer to page: 508

# Paediatric Cots



For NDIS Item Code, refer to page: 508



## Smile Paediatric Ward Bed



- Three function electrically adjustable hospital bed designed with growing people in mind
- Colourful side rails and decals to meet interior design themes and add to a more cheerful patient environment
- Capacity to lengthen at the press of a button to transition from child to young adult size proportions
- -15° to 15° Trendelenburg
- Biocote antibacterial surface treatment for improved infection control
- Durable blow molded side rails with gas spring dampeners for smooth operation
- Onboard battery provides ward mobility and emergency backup
- Integrated control panel in foot end section for carer and parent access
- 150mm Castors



Code	Description	Length	Width	Height	Patient Surface Length	Patient Surface Width	Backrest Angle	Knee Bend Angle	SWL
PED490100	Smile Paediatric Ward Bed	1830 - 2180 mm	890 mm	550 - 950 mm	1580-1980 mm	890 mm	0° to 70°	0° to 36°	150 kg



## Matris Rooming-In Crib



- Transparent side panels allow full visibility
- Ventilation sections in either end to promote flow of clean air to the baby
- Drop down side sections allow reinforced padded side sections to lay across the gap between crib and bed, creating a more natural and intimate maternal bonding experience, and a safe lateral transfer of the baby
- Biocote antibacterial surface treatment for improved infection control
- Automatically locking wheels ensure stability and safety with active handle compression required for brake release
- Integrated Trendelenburg tilt function to assist with clinical requirements such as relieving reflux
- Gas assisted height adjustment for ergonomically sound manual handling for mother and baby
- -6° to 12° Trendelenburg
- 125mm Castors

Code	Description	Length	Width	Height	Patient Surface Length	Patient Surface Width
PED490200	Matris Rooming-In Crib	890 mm	520 mm	490 - 710 mm	660 mm	340 mm

### General Enquiries

P 1300 133 120 | E sales@aidacare.com.au | W www.aidacare.com.au



## Paediatric Cot

- Soft internal edge design with smooth glide side and end panels
- Weightless, height adjustable side and end panels
- 12° Trendelenburg
- Utensil carry tray

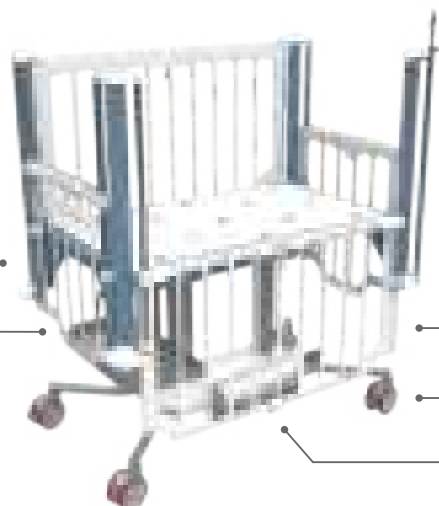

- Stainless steel and aluminium construction
- Lightweight aluminium side and end panels
- Buffers
- Obstruction free base design for access on all sides and ends
- 125mm castors
- Oxygen bottle carrier



Code	Description	Length	Width	Height	Warranty
WAT830550	Paediatric Cot - Fixed Height	1580 mm	880 mm	1405 mm	5 Years
GSP504120	Mattress - Paediatric Cot			50 mm	



## Paediatric Cot & Bath

- Compact and lightweight design moves easily and suits even the smallest room layouts
- Gas assisted height adjustment makes patient handling and lifting bath a simple and ergonomic task
- Lockable mobility castors on base for ease of transportation
- Manufactured to AS2130 standard

- Hygienic removable bath supports infection control management processes
- Convenient storage (accessory) basket on base ensures essential items are always at hand
- Powder coated frame for easy cleaning and infection control management



Code	Description	Length	Width	Height	Warranty
WAT829000	Baby Bassinet Mobile Single Acrylic - Small	780 mm	400 mm	990 mm	3 Years
WAT829000	Baby Bassinet Mobile Single Acrylic - Large	780 mm	400 mm	990 mm	3 Years



## Baby Bassinet Mobile

- Moulded acrylic bassinet, can be elevated at either end
- 2 x moulded plastic utility trays
- Soft vinyl-clave covered mattress

Code	Description	Length	Width	Height	Warranty
WAT829000	Baby Bassinet Mobile Single Acrylic	780 mm	400 mm	990 mm	3 Years
WAT829600	Baby Bassinet Mobile Single S/Steel	780 mm	400 mm	990 mm	3 Years
WAT829700	Baby Bassinet Mobile Twin Acrylic	805 mm	655 mm	990 mm	3 Years
WAT829800	Baby Bassinet Mobile Twin S/S	805 mm	655 mm	990 mm	3 Years



## Paediatric Cot

- Paediatric Cot features a stainless steel or epoxy coated frame
- Standard foam 50mm mattress
- Four castors - two lockable for stability
- Mechanisms to operate drop sides located outside of the cot at mattress base for added safety
- Hand operated Trendelenburg 12° above horizontal
- Meets AS 2130

Code	Description	Length	Width	Warranty
WAT829900	Paediatric Cot S/S	1440 mm	760 mm	3 Years
WAT830500	Paediatric Cot White	1440 mm	760 mm	3 Years
WAT830100	Paediatric Cot Double Latch	WAT830900	Paediatric Cot Oxygen Carrier	
WAT830700	Paediatric Cot Mattress Economy	WAT831000	Paediatric Cot Safety Enclosure	
WAT831200	Paediatric Cot Tray	WAT831100	Paediatric Cot Safety Enclosure Coated	
WAT830600	Paediatric Cot IV Pole			



## Sleepform

- Sleepform is a vacuum mattress moulded to support the user as part of a 24hr positioning program
- Promotes symmetry, reduces pain, slows the development of deformities
- For children, adolescents and adults with special needs
- For use at home or in hospital and respite care centres



Code	Description	Suitable For	Warranty
PED477010	Sleepform, Size 1, Ages 0 - 1 years	Cot	2 Years
PED477020	Sleepform, Size 2, Ages 1 - 5 years	Cot	2 Years
PED477030	Sleepform, Size 3, Ages 1 - 5 years	Single Bed	2 Years
PED477040	Sleepform, Size 4, Ages 5 - 18 years	Single Bed	2 Years



# Other Paediatric



For NDIS Item Code, refer to page: 508



## Advance Bath Chair

**LECKEY<sup>®</sup>**

- Supports and holds the child to assist with bathing
- Easy-to-use adjustable legs can be set up prior to use
- Simple lever can be used to adjust the backrest recline position in the bath
- Washable, mesh fabric is breathable and soft to touch
- Folds flat for easy storage and transportation
- Accessories include head support, leg supports and shower trolley



Code	Description	Seat Width	Seat Depth	Back Height	S.W.L	Warranty
PED478480	Advance Bath Chair Size 1, Ages 1 - 5 years	425 mm	225 mm	350 mm	72 kg	2 Years
PED478500	Advance Bath Chair Size 2, Ages 4 - 9 years	425 mm	275 mm	400 mm	72 kg	2 Years
PED478510	Advance Bath Chair Size 3, Ages 8 - 14 years	425 mm	335 mm	460 mm	72 kg	2 Years
PED478530	Advance Bath Chair Size 4, Ages 12 - 18 years	425 mm	400 mm	550 mm	72 kg	2 Years



## Otter Bathing System

- Durable plastic frame is lightweight for carrying with easy to clean surfaces
- Soft fabric gives comfortable support and is easily removable for machine washing
- Seat fabric can be slipped off to bathe a child sitting on bottom of bath, supported by the chair back
- Adjustable slip resistant legs
- Height adjustable
- Leg straps enable abduction and adduction for optimum postural control
- Two positioning straps secure child for safety
- Head cushions are height and width adjustable without tools and provide support and comfort
- Can also be used as lateral supports for maintaining straight-line upper body balance
- Folds flat for easy storage and transportation
- Available in 3 sizes - Specify size on request
- Accessories available on request



Code	Description	Seat Width	Seat Depth	Height	S.W.L	Warranty
PED480830	Otter Bathing System	370 mm	330 - 420 mm	450 - 810 mm	30 - 75 kg	2 Years

### General Enquiries

P 1300 133 120 | E sales@aidacare.com.au | W www.aidacare.com.au



### Potty Chair Child

- The freestanding Potty Chair assists the user with limited mobility to comfortably toilet or shower
- Contoured fibreglass moulded shell seat, supplied standard with pelvic harness
- Powder coated mild steel frame that is zinc treated for corrosion resistance
- Accessories available including footrest, harness and chest strap
- Fitted with non-slip rubber tips



Code	Description	Seat Width	Seat Height	Product Weight	S.W.L	Warranty
PED478390	Potty Chair - Child Mobile	310 mm	475 - 645 mm	10 kg	80 kg	1 Year
PED478400	Potty Chair Tilt In Space - Child	310 mm	670 mm	16 kg	80 kg	1 Year
PED478410	Potty Chair - Child Footrest					1 Year



### Seahorse Sanichair

- The design of the Sanichair is based around two sizes of frame each accommodating two sizes of liners to provide four size options. This allows the liner to be replaced with the next size as the child grows
- Fits over the majority of toilets whilst the high centre of gravity enables the child to be tilted for washing and showering
- Soft foam liners for comfort and hygiene
- Positive locking on the headrest, footrest and potty, adding extra security for the child and carer
- Elongated aperture for easier personal cleaning
- Includes contoured seat, water and chip resistant metal frame, large castors, removable splash guard pommel, large capacity potty, height adjustable headrest and footrest, body harness and foot straps
- Headrest sold separately

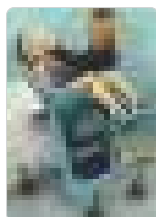

Code	Description	Overall Width	Overall Depth	Seat Height	Back Height	S.W.L	Warranty
PED479361	Small, 3 - 9 years	550 mm	730 mm	520 mm / 625 mm	430 mm	102 kg	2 Years
PED479360	Large, 9 - 16 years	630 mm	825 mm	520 mm / 625 mm	540 mm	102 kg	2 Years
PED479366	Seahorse Sanichair Headrest						

Refer to Pages 288 - 289 in the Wheelchairs & Positioning Section to View Our Paediatric Wheelchairs

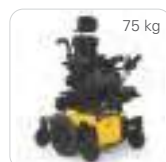

Sunrise Medical ZM-310 Power Wheelchair



Pride Mobility Sparky Power Wheelchair

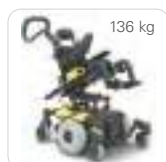

Pride Mobility Q610 Power Wheelchair

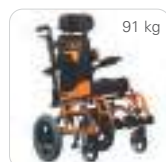

Invacare Freedom NXT Manual Wheelchair



Invacare Action 3 Junior Manual Wheelchair

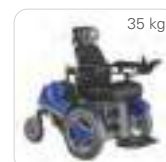

Permobil Koala Power Wheelchair

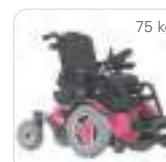

Permobil K300 PS Junior Power Wheelchair

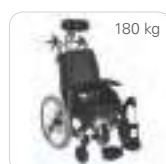

Aspire Rehab RX JNR Wheelchair



Ottobock Start Junior Manual Wheelchair

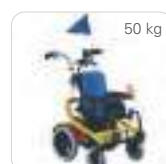

Ottobock Skippi Power Wheelchair

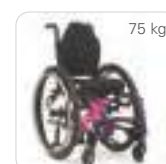

Sunrise Medical Zippie X'CAPE Manual Wheelchair

Refer to Page 95 in the Bedroom section to view our Paediatric Sleep Positioning Aids



Star Pillow



Horseshoe Pillow



Sidney Side Lyer

CONTACT US FOR  
A FLYER



# MOBILITY SCOOTERS

Sonic Scooter

GT Scooter





# Mobility Ramps

# Contents

P 235 Modular & Rubber Ramps



Custom Ramps – DVA Home Modifications (Refer to Page 12)

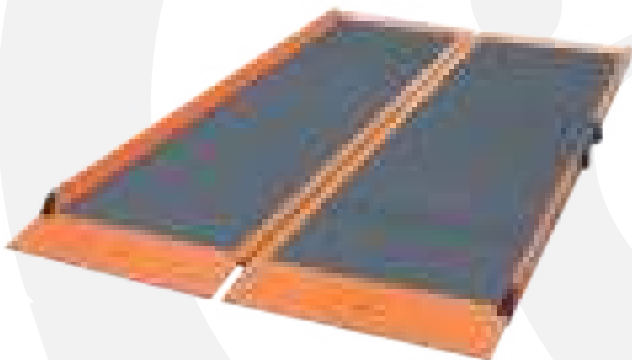





### Aspire Public Transport Ramp

- Super Lightweight aluminium ramp made with carbon fibre
- Designed in conjunction with public transport professionals
- Striking orange colour ensures the ramp is always in sight
- Foldable design allows for a quick, portable ramp solution



Code	Description	Length	Total Width	Platform Width	Folded Width	Folded Height	Product Weight	S.W.L	Warranty
RAM656800	Public Transport Ramp	1500 mm	850 mm	800 mm	435 mm	55 mm	10 kg	400 kg	2 years



### Silver Star Ramps

- Lightweight portable aluminium ramps that folds easily in half for convenient storage & transportation

Code	Description	Width	Length	Max. Height	Product Weight	S.W.L	Warranty	DVA:
RAM656370	Silver Star Ramp	750 mm	610 mm	180 mm	5 kg	272 kg	2 Years	AL11
RAM656380	Silver Star Ramp	750 mm	910 mm	250 mm	8 kg	272 kg	2 Years	AL11
RAM656390	Silver Star Ramp	750 mm	1220 mm	300 mm	11 kg	272 kg	2 Years	AL11
RAM656400	Silver Star Ramp	750 mm	1520 mm	330 mm	13 kg	272 kg	2 Years	AL11
RAM656410	Silver Star Ramp	750 mm	1830 mm	510 mm	16 kg	272 kg	2 Years	AL11



### Personal & Senior Ramps

- The Personal Ramp is a lightweight portable ramp, allows easy access in domestic situations including climbing curbs. Features a strap for storage on back of wheelchair and folds up to allow for storage and transportation
- The Senior Ramp is lightweight and strong and folds easy to assist in storage and transportation
- Available in a large range of sizes

Code	Description	Width	Length	Max. Height	Product Weight	S.W.L	Warranty	DVA:
RAM656200	Personal Ramp	745 mm	700 mm	175 mm	4.7 kg	300 kg	1 Year	AL11
RAM656210	Carry Bag to suit Personal Ramp							AL11
RAM656360	Senior Ramp 900	750 mm	900 mm	225 mm	4.8 kg	300 kg	1 Year	AL11
RAM656310	Senior Ramp 1200	750 mm	1200 mm	300 mm	8.3 kg	300 kg	1 Year	AL11
RAM656320	Senior Ramp 1350	750 mm	1350 mm	337 mm	8.5 kg	300 kg	1 Year	AL11
RAM656330	Senior Ramp 1650	750 mm	1650 mm	412 mm	10.8 kg	300 kg	1 Year	AL11
RAM656340	Senior Ramp 2000	750 mm	2000 mm	500 mm	11.7 kg	300 kg	1 Year	AL11
RAM656345	Senior Ramp 2500	750 mm	2500 mm	630 mm	14.8 kg	300 kg	1 Year	AL11
RAM656350	Senior Ramp 3500	750 mm	3500 mm	875 mm	24.7 kg	300 kg	1 Year	AL11



### Multipurpose Ramps

- Assists mobility equipment users and carers to navigate steps and gaps
- Lightweight portable ramp with multiple uses
- Ideal for commercial and travel situations
- Folds up to allow for storage and transportation
- Strap for storage on back of wheelchair
- Ramp bag also available

Code	Description	Width	Length	Max. Height	Product Weight	S.W.L	Warranty	DVA:
RAM656180	Multipurpose Ramp	835 mm	870 mm	220 mm	5.6 kg	300 kg	1 Year	AL11
RAM656190	Carry Bag to suit Ramp Multipurpose						1 Year	AL11



### Edge Barrier Limited (EBL) Ramps

- The Edge Barrier Limited (EBL) has the added security of edge barriers
- Available in a large range of sizes
- Particularly suited to providing instant access to buses, trains and buildings where a permanent ramp is impractical and folds easily for storage and transportation

Code	Description	Width	Length	Max. Height	Product Weight	S.W.L	Warranty	DVA:
RAM656170	EBL Ramp 900	750 mm	900 mm	225 mm	6 kg	300 kg	1 Year	AL11
RAM656090	EBL Ramp 1200	820 mm	1200 mm	300 mm	9.7 kg	300 kg	1 Year	AL11
RAM656100	EBL Ramp 1350	820 mm	1350 mm	337 mm	11.1 kg	300 kg	1 Year	AL11
RAM656110	EBL Ramp 1650	820 mm	1650 mm	412 mm	13 kg	300 kg	1 Year	AL11
RAM656120	EBL Ramp 2000	820 mm	2000 mm	500 mm	13.7 kg	300 kg	1 Year	AL11
RAM656130	EBL Ramp 2500	820 mm	2500 mm	625 mm	23 kg	300 kg	1 Year	AL11
RAM656140	EBL Ramp 3000	820 mm	3000 mm	750 mm	27.3 kg	300 kg	1 Year	AL11
RAM656150	EBL Ramp 3500	820 mm	3500 mm	875 mm	31.5 kg	300 kg	1 Year	AL11



### Rubber Threshold Ramps

- Assists mobility equipment users and carers to navigate steps and bumps
- Made from recycled rubber, these lightweight threshold ramps are ideal for doorways

Code	Description	Width	Length	Max. Height	Product Weight	S.W.L	Warranty	DVA:
RAM656211	Rubber Threshold Ramp - Small	200 mm	1010 mm	25 mm	4 kg	300 kg	1 Year	AL11
RAM656212	Rubber Threshold Ramp - Large	400 mm	1140 mm	50 mm	13 kg	300 kg	1 Year	AL11



### Threshold Ramps (Modular)

- Threshold Ramps provide a durable, safe means of navigating uneven household surfaces including small steps and doorways
- A hidden dovetail locking system allows for easy installation

Code	Description	Width	Length	Height	S.W.L	Warranty
1 RAM656560	Ramp - RubberThreshold.- 1" Rise - 1 Piece Only	991 mm	265 mm	25 mm	385 kg	1 Year
2 RAM656570	Ramp - RubberThreshold.- 1.5" Rise - 2 Piece Set	1041 mm	440 mm	38 mm	385 kg	1 Year
3 RAM656580	Ramp - RubberThreshold.- 2" Rise - 3 Piece Set	1080 mm	615 mm	51 mm	385 kg	1 Year
4 RAM656590	Ramp - RubberThreshold.- 2.5" - 4 Piece Set	1123 mm	790 mm	64 mm	385 kg	1 Year
5 RAM656600	Ramp - RubberThreshold.- 3" Rise - 5 Piece Set	1168 mm	981 mm	76 mm	385 kg	1 Year

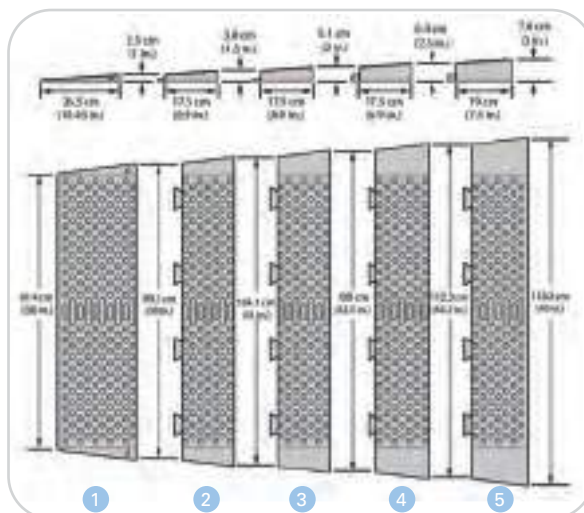



# Contents

- P 253 Seat Walkers / Rollators & Accessories
- P 262 Walking Frames
- P 264 Forearm Walkers
- P 266 Walking Sticks
- P 268 Crutches
- P 270 General Accessories

# Mobility Walking Frames & Aids





# Seat Walkers / Rollators & Accessories

**I ♥ ndis** For NDIS Item Code, refer to page: 508

Brochures also available. Please contact us for a copy.

## Aspire Vogue Lightweight 2 Seat Walker



Advanced Locking Handbrakes



New Deeper 240mm Seat

Cane Holder attachment included

Smooth Height Adjustment with AUTOLOCATE

Unbreakable TPE Super Soft Wheels



Luxury Look and Feel

New Wider Curved Backrest

For Comfort and Support



Removable Utility Bag



220mm Folding Width Minimises Storage Space. Locks when Folded



Luxury Look & Feel Danish Designed



Red



Champagne



Code	Description	Overall Height	Overall Length	Overall Width	Folded Width	Seat Depth	Seat Width	Seat Height	Wheel Size	Total Weight	Bag S.W.L	DVA:
WAF705310RE	Vogue Walker - Red	785 - 920 mm	655 mm	620 mm	220 mm	240 mm	190 mm	540 mm	8"	6.2 kg	5 kg	AP12
WAF705310CH	Vogue Walker - Champagne	785 - 920 mm	655 mm	620 mm	220 mm	240 mm	190 mm	540 mm	8"	6.2 kg	5 kg	AP12

Mobility Walking Frames & Aids

### DVA Contact Details

P 1300 888 052 | F 1300 787 052 | E [dva@aidacare.com.au](mailto:dva@aidacare.com.au)



For NDIS Item Code, refer to page: 508





## Aspire Vogue Carbon Fibre Seat Walker



Smooth Height Adjustment with AUTOLOCATE



**Cane Holder**  
attachment included

Super Lightweight Carbon Fibre Frame

Unbreakable TPE Super Soft Wheels



New Wider Curved Backrest

For comfort and support



Locks when Folded

220mm Folding Width Minimises Storage Space



Removable Utility Bag



Luxury Look & Feel  
Danish Designed



Candy Red



Carbon Fibre



Code	Description	Overall Height	Overall Length	Overall Width	Folded Width	Seat Depth	Seat Width	Seat Height	Wheel Size	Total Weight	Bag S.W.L
WAF705350	Vogue Walker - Carbon Fibre	695 - 920 mm	680 mm	600 mm	225 mm	240 mm	460 mm	550 mm	8"	5 kg	5 kg
WAF705360	Vogue Walker - Carbon Fibre	770 - 1040mm	680mm	605mm	240mm	225mm	460mm	620mm	8"	5 kg	5 kg

## Aspire Vogue Forearm Seat Walker



Advanced Locking Handbrakes



Smooth Height Adjustment with AUTOLOCATE



Unbreakable TPE Super Soft Wheels



User Comfort

Super-soft Wheels and Padded Forearm Surfaces Absorb Bumps and Jolts Creating a Smooth, Comfortable Ride



Luxury Look & Feel  
Danish Designed



White



Code	Description	Overall Height	Overall Length	Overall Width	Folded Width	Seat Depth	Seat Width	Seat Height	Wheel Size	Total Weight	Bag S.W.L	DVA:
WAF705400	Vogue Forearm Walker - White	1020 - 1270 mm	660 mm	620 mm	225 mm	240 mm	460 mm	620 mm	8"	9 kg	5 kg	AP12

Smart Posture System

Height, Angle and Depth Adjustable Forearm Supports Achieve Optimal Centre of Gravity for Improved Balance and Weight Distribution



Locks when Folded

220mm Folding Width Minimises Storage Space



Rehab Focus

Easy to Push with a Small Turning Circle





## Aspire Vogue Indoor Walker



Super  
Lightweight!  
**5.2kg**  
Meal Tray  
Inclusive

Soft Touch Braking

Smooth Height Adjustment with AUTOLOCATE

Luxury Look & Feel



Walker Cane Holder Comes Included

Removable Meal Tray



Small Folding Footprint

Removable Storage Bag



Red / Black Champagne / Black

1  
Year  
Warranty

S.W.L  
**110kg**

Code	Description	Overall Height	Overall Length	Overall Width	Folded Width	Wheel Size	Total Weight	Bag S.W.L	Tray S.W.L	S.W.L	DVA:
WAF705100RE	Vogue Walker - Indoor - Red/Black	860 - 970 mm	650 mm	540 mm	270 mm	6"	5.2kg	5kg	5kg	110kg	AP12
WAF705100CH	Vogue Walker - Indoor - Champagne/Black	860 - 970 mm	650 mm	540 mm	270 mm	6"	5.2kg	5kg	5kg	110kg	AP12

## Aspire Vogue Seat Walker Accessories

DVA: AP22



Crutch & Cane Holder  
WAA695611



Single Hand Brake System  
WAA695641



Adjustable Height IV Pole  
WAA695651



Oxygen Bottle Holder Bag  
WAA695600



Night Light - LED Lamp  
WAA695630

Note: Crutch and Cane Holder, Single Hand Brake System and Adjustable Height IV Pole are not compatible with the Vogue Indoor Walker

### DVA Contact Details

P 1300 888 052 | F 1300 787 052 | E [dva@aidacare.com.au](mailto:dva@aidacare.com.au)



For NDIS Item Code, refer to page: 508



## Aspire Deluxe Seat Walker



Anatomically Designed, Latex-Free Handles



Ultra-soft hand brakes with palm ball lock for increased comfort, especially for users with arthritis

Robust Aluminium Frame



Deluxe, in-line rear wheels and brake mechanism

Discreet Pocket Compartment



Allows the user to store smaller objects safely



Adjustable Handle Height

Curved and Padded Backrest



Padded Seat Flips up



Solid, Puncture-Proof 8" Wheels

Puncture-proof wheels for increased manoeuvrability over various surfaces



Red



Blue



Code	Description	Overall Height	Overall Length	Overall Width	Seat Depth	Seat Width	Seat Height	Backrest Height	Folded Width	Castor Size	Unit Weight	DVA:
WAF705750RE	Deluxe Seat Walker - Red	834 - 989 mm	764 mm	605 mm	305 mm	355 mm	587 mm	836 mm	245 mm	8"	7 kg	AP12
WAF705750BL	Deluxe Seat Walker - Blue	834 - 989 mm	764 mm	605 mm	305 mm	355 mm	587 mm	836 mm	245 mm	8"	7 kg	AP12

## Aspire Classic 8" Seat Walker



Adjustable Handle Height



Robust Aluminium Frame



Padded Seat Flips Up



Anatomically Designed, Latex-Free Handles

Ultra-soft Hand Brakes with Palm Ball Lock for Increased Comfort, Especially for Users with Arthritis



Curved and Padded Backrest Offers Seated Support



Discreet Pocket Compartment

Allows the User to Store Smaller Objects Safely



Solid, Puncture-Proof 8" Wheels



Red



Blue



Code	Description	Overall Height	Overall Length	Overall Width	Seat Depth	Seat Width	Seat Height	Backrest Height	Folded Width	Castor Size	Unit Weight	DVA:
WAF705700RE	Classic 8" Seat Walker - Red	817 - 972 mm	660 mm	628 mm	305 mm	355 mm	584 mm	815 mm	200 mm	8"	7 kg	AP12
WAF705700BL	Classic 8" Seat Walker - Blue	817 - 972 mm	660 mm	628 mm	305 mm	355 mm	584 mm	815 mm	200 mm	8"	7 kg	AP12

### General Enquiries

P 1300 133 120 | E sales@aidacare.com.au | W www.aidacare.com.au



## Aspire Classic 6" Seat Walker



Anatomically Designed, Latex-Free Handles

Ultra-soft Hand Brakes with Palm Ball Lock for Increased Comfort, Especially for Users with Arthritis



Adjustable Handle Height



Curved and Padded Backrest Offers Seated Support



Robust Aluminium Frame



Discreet Pocket Compartment

Allows the User to Store Smaller Objects Safely



Padded Seat Flips up



Solid, Puncture-Proof 6" Wheels



Red



Blue



Code	Description	Overall Height	Overall Length	Overall Width	Seat Depth	Seat Width	Seat Height	Backrest Height	Folded Width	Castor Size	Unit Weight	DVA:
WAF709600RE	Classic 6" Seat Walker - Red	760 - 915 mm	624 mm	615 mm	305 mm	355 mm	528 mm	769 mm	200 mm	6"	6 kg	AP12
WAF709600BL	Classic 6" Seat Walker - Blue	760 - 915 mm	624 mm	615 mm	305 mm	355 mm	528 mm	769 mm	200 mm	6"	6 kg	AP12

## Aspire Mini Seat Walker



Anatomically Designed, Latex-Free Handles

Ultra-soft Hand Brakes with Palm Ball Lock for Increased Comfort, Especially for Users with Arthritis



Adjustable Handle Height



Curved and Padded Backrest Offers Seated Support



Robust Aluminium Frame



Discreet Pocket Compartment

Allows the User to Store Smaller Objects Safely



Padded Seat Flips up



Solid, Puncture-Proof 6" Wheels



Red



Blue



Code	Description	Overall Height	Overall Length	Overall Width	Seat Depth	Seat Width	Seat Height	Backrest Height	Folded Width	Castor Size	Unit Weight	DVA:
WAF705800RE	Mini Seat Walker - Red	743 - 905 mm	556 mm	615 mm	305 mm	355 mm	490 mm	690 mm	200 mm	6"	6 kg	AP12
WAF705800BL	Mini Seat Walker - Blue	743 - 905 mm	556 mm	615 mm	305 mm	355 mm	490 mm	690 mm	200 mm	6"	6 kg	AP12

### DVA Contact Details

P 1300 888 052 | F 1300 787 052 | E [dva@aidacare.com.au](mailto:dva@aidacare.com.au)



For NDIS Item Code, refer to page: 508







## Aspire XL Seat Walker



Adjustable Handle Height



Robust Aluminium Frame



Extra Large Padded Seat Flips Up



Wide Padded Seat  
Increased 180kg  
Safe Working Load



Anatomically Designed, Latex-Free Handles

Ultra-soft Hand Brakes with Palm Ball Lock for Increased Comfort, Especially for Users with Arthritis



Curved and Padded Backrest for Seated Support



Discreet Pocket Compartment for Storage

Allows the User to Store Smaller Objects Safely



Solid, Puncture-Proof 8" Wheels



Silver



Code	Description	Overall Height	Overall Length	Overall Width	Seat Depth	Seat Width	Seat Height	Backrest Height	Folded Width	Castor Size	Unit Weight	DVA:
WAF750020SL	XL Seat Walker	850 - 982 mm	697 mm	732 mm	340 mm	495 mm	560 mm	850 mm	230 mm	8"	8 kg	AP12

## Aspire Push Down Seat Walker



Anatomically Designed, Latex-Free Handles

Adjustable Handle Height



Padded Seat Flips up



Robust Aluminium Frame



Weight Activated Brakes

Ideal for users with arthritis



Curved and Padded Backrest for Seated Support



Discreet Pocket Compartment for Storage

Allows the user to store smaller objects safely



Solid, Puncture-Proof 7" Wheels



Red



Blue



Code	Description	Overall Height	Overall Length	Overall Width	Seat Depth	Seat Width	Seat Height	Backrest Height	Folded Width	Castor Size	Unit Weight	DVA:
WAF705600RE	Push Down Seat Walker - Red	851 - 962 mm	656 mm	616 mm	305 mm	355 mm	580 mm	815 mm	255 mm	7"	7 kg	AP12
WAF705600BL	Push Down Seat Walker - Blue	851 - 962 mm	656 mm	616 mm	305 mm	355 mm	580 mm	815 mm	255 mm	7"	7 kg	AP12

### General Enquiries

P 1300 133 120 | E sales@aidacare.com.au | W www.aidacare.com.au



## Aspire Superlite Adjustable Seat Walker



Compact Folding for Storage and Transport



Convenient Storage Bag Doubles as Seat

Height Adjustable Seat



Super  
Lightweight!  
5.8kg



Height Adjustable Handles



Tool Free Assembly

Swivelling 6" Front Wheels



Champagne



Code	Description	Overall Height	Overall Length	Overall Width	Seat Depth	Seat Width	Seat Height	Backrest Height	Folded Width	Castor Size	Unit Weight	DVA:
WAF709650CH	Superlite Adjustable Seat Walker	740 - 910 mm	550 mm	600 mm	320 mm	350 mm	460 - 590 mm	700 mm	200 mm	6"	5 kg	AP12

## Aspire Meal Tray Walker



Lockable Hand Brakes Provide Additional Safety



Clip on Plastic Trays with Outer Lip Edge



Captures Spillage and Prevents Items from Slipping Off

Sturdy & Robust Walking Aid



Provides a means of Transporting Meals or Other Items from Room to room



Height Adjustable Handles



Easy Clean Frame & Food Trays



Tool Free Assembly



Swivelling 6" Front Wheels



Cream



Code	Description	Overall Height	Overall Length	Overall Width	Lower Tray Height	Upper Tray Height	Tray Width	Castor Size	Total Weight	DVA:
DLG272061	Meal Tray Walker	770 - 920 mm	560 mm	585 mm	430 mm	696 mm	450 mm	6"	8 kg	AH14

### DVA Contact Details

P 1300 888 052 | F 1300 787 052 | E [dva@aidacare.com.au](mailto:dva@aidacare.com.au)



For NDIS Item Code, refer to page: 508



## Aspire Tri Wheel Walker TOP SELLER



Adjustable Handle Height



Storage bag included as per standard

Lightweight Aluminium frame

8" solid, puncture-proof wheel, swivels 360° for increased maneuverability



Ultra-soft locking hand brakes with palm ball for comfort



Meal tray and basket included as standard

Folding mechanism for easy transport and storage

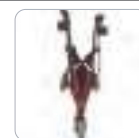

Red



Code	Description	Overall Height	Overall Length	Overall Width	Folded Width	Castor Size	Product Wt.	S.W.L	Warranty
WAF705500	Tri Wheel Walker	800 - 920 mm	730 mm	645 mm	275 mm	8"	5.5 kg	115 kg	1 Year

## Aspire Knee Walker



Commonly Used in Place of Crutches During Recovery After Ankle or Foot Surgery



Adjustable Handle Bar Height



Quick Adjust for Left or Right Leg



Compact & Easy to Fold



Height Adjustable Platform



Blue



Code	Description	Overall Height	Overall Width	Knee Pad Width	Knee Pad Depth	Knee Pad Height	Handle Height	Product Wt.	S.W.L
WAF712100BL	Knee Walker	840 - 970 mm	430 mm	180 mm	360 mm	840 - 970 mm	840 - 970 mm	10 kg	136 kg

## Aspire Seat Walker Accessories



**Oxygen Bottle Holder for Seat Walkers**  
Attaches to A-Frame Seat Walkers [WAA686905](#)



**Walking Stick Holder for Seat Walker**  
Attaches to A-Frame Seat Walkers. Top mount clamp to securely hold the walking stick in place [WAA686925](#)



**Clip on Seat Walker Bag**  
Accessory to suit Aspire Classic, Mini, Deluxe, Push-down & XL Seat Walker  
[WAA686915](#) - General  
[WAA686920](#) - Aspire XL



**Seat Walker/A-Frame Walker Basket**  
Clamp on basket to suit Aspire Seat Walkers  
[WAA686908](#) - Aspire XL  
[WAA686909](#) - Classic, Mini & Push Down  
[WAA686910](#) - Deluxe



### Shopper Multi Walker

- Provides assistance to those who need confidence walking and require rest en route
- Heavy duty walker with excellent durability
- Removable tray to access rubber seat
- Folds away for storage or transportation
- 600mm seat height
- Large wheels for excellent manoeuvrability and stability

Code	Description	Between Arms	Seat Ht.	Handle Ht.	Product Wt.	S.W.L	Warranty	DVA:
WAF706100	Shopper Multi Walker	570 mm	600 mm	805 - 930 mm	11.7 kg	130 kg	1 Year	AP12



### Maxicare Walker

- Manufactured from powder coated mild steel
- Walker can be folded and stowed easily into a typical size car boot
- Comes with a removable serving tray, basket and a walking stick holder
- Larger seat with in-built handle
- Strong frame features reinforced front and rear forks
- Large 200mm (8") wheels
- Backrest is rigid

Code	Description	Between Arms	Seat Ht.	Handle Ht.	Product Wt.	S.W.L	Warranty
WAF699400	Maxicare Walker	570 mm	560 mm	850 - 930 mm	15.5 kg	225 kg	1 Year



### Lets Go Outdoor Walker

- Lightweight, Stylish Folding X Frame Walker
- Large Front & Rear Wheels for ease of use outdoors
- Easy to use soft touch brakes
- Adjustable handles to suit most user heights
- Large 245mm (9.5") front wheels
- Large 200mm (8") back wheels

Code	Description	Length	Width	Seat Ht.	Handle Ht.	Product Wt.	S.W.L	Wty	DVA:
WAF706160	Lets Go Outdoor Walker	640 mm	570 mm	590 mm	780 - 960 mm	6.6kg	130kg	1 Year	AP12



### Lets Go Indoor Walker

- Narrow width and easy to turn excellent for indoor use
- Easy to use brake can be activated with one hand
- Supplied with removable plastic tray and carry bag
- Large 200mm (8") wheels

Code	Description	Length	Width	Tray Ht.	Handle Ht.	Product Wt.	S.W.L	Wty	DVA:
WAF706150	Lets Go Indoor Walker	630 mm	540 mm	680 mm	780 - 960 mm	6.5kg	100kg	1 Year	AP12



### Airgo 'Fusion' Side Folding Walker

- Lightweight side-folding rollator and transport chair in one design
- Converts to a transport chair
- Frame locks together when folded
- Padded seat and a full backrest
- Ergonomic handgrips
- Features senior friendly tool-free brake adjustment knob

Code	Description	Length	Width	Seat Ht.	Handle Ht.	Product Wt.	S.W.L	Wty
WAF707150	Airgo Fusion Walker	720 mm	500 mm	510 mm	760 - 930 mm	7.7 kg	136 kg	3 months



### Aspire Meal Trolley

- Ideal for use in the house, this mobile kitchen trolley gives greater independence for the user and features removable plastic trays.
- Height adjustable frame
- Tool Free Assembly, Clip on Plastic Trays
- Easy Clean Frame & Food Trays
- 2 locking castors

Code	Description	Length	Width	Tray Ht.	DVA:
DLG272060	Meal Trolley	503 mm	460 mm	810 - 937 mm	AH14



# Walking Frames



For NDIS Item Code, refer to page: 508



## Aspire Side Folding Walking Frame



Lightweight aluminium frame

Compact folding for storage and transport



Height Adjustable Legs

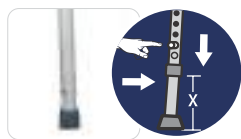

Designed to help a person remain mobile and independent by providing support

Adding wheels converts the walking frame into a wheeled walker while skis enable the back legs to glide smoothly



Code	Description	Overall Height	Overall Width	Overall Depth	Product Wt.	S.W.L	Warranty	DVA:
WAF710100	Side Folding Walking Frame	760 - 940 mm	530 mm	420 mm	2.6 kg	136 kg	1Year	AP12
WAF710100K	Side Folding Walking Frame / Inc. Skis & Wheels	760 - 940 mm	530 mm	420 mm	2.6 kg	136 kg	1Year	AP12
WAA686550	Walker Skis							AP14
WAA686560	Walker Wheels							AP14

## Aspire Side Folding Walking Frame Accessories

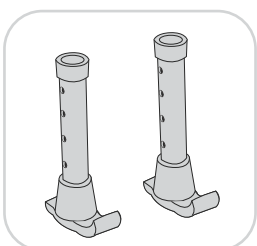

### Walker Skis

\*Fits other Walking Frames

- Attach these skis to the rear legs of the walking frame to gently glide over surfaces

Code	Description	DVA:
WAA686550	Walker Skis	AP14

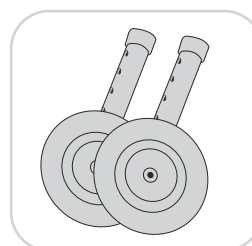

### Walker Wheels

\*Fits Side Walking Frame only

- Allows natural movement for a user, minimising the need to lift the walking frame.

Code	Description	DVA:
WAA686560	Walker Wheels	AP14

### General Enquiries

P 1300 133 120 | E sales@aidacare.com.au | W www.aidacare.com.au



## Mobilisor (Paediatric)

- Mobilisor range is a sturdy, folding, height - adjustable walking frame for children
- Includes fixed front wheels and rear glides

Code	Description	Width	Handle Ht.	S.W.L	Warranty
WAF704200	Mobilisor Child	440 mm	600 - 790 mm	60 kg	1 Year
WAF708600	Mobilisor Junior	495 mm	670 - 960 mm	80 kg	1 Year



## Aluminium Non-Folding Walking Frame

- Provides assistance for those who have difficulty walking
- Lightweight aluminium frame ideal for indoor use
- Height adjustable to suit user requirements
- Supplied with four rubber tips
- Ferrule of 25mm
- Lightweight at only 1.9kg

Code	Description	Width	Handle Ht.	S.W.L	Warranty	DVA:
WAF704900	A/ Walking Frame - Small	560 mm	665 - 740 mm	160 kg	1 Year	AP12
WAF704800	A/ Walking Frame - Medium	560 mm	765 - 840 mm	160 kg	1 Year	AP12
WAF704700	A/ Walking Frame - Large	560 mm	865 - 940 mm	160 kg	1 Year	AP12
WAF704900K	A/ Walking Frame with Wheels & Ski's - Small	560 mm	665 - 740 mm	160 kg	1 Year	AP12
WAF704800K	A/ Walking Frame with Wheels & Ski's - Medium	560 mm	765 - 840 mm	160 kg	1 Year	AP12
WAF704700K	A/ Walking Frame with Wheels & Ski's - Large	560 mm	865 - 940 mm	160 kg	1 Year	AP12



## Aluminium Folding Walking Frame

- Provides assistance for those who have difficulty walking
- Folds flat for easy transportation and storage
- Lightweight aluminium frame ideal for indoor use
- Height adjustable to suit user requirements
- Supplied with four rubber tips
- Ferrule of 25mm
- Lightweight at only 2kg

Code	Description	Width	Handle Ht.	S.W.L	Warranty	DVA:
WAF706700	A/ Folding Walking Frame - Small	610 mm	710 - 787 mm	127 kg	1 Year	AP12
WAF706800	A/ Folding Walking Frame - Medium	610 mm	787 - 860 mm	127 kg	1 Year	AP12
WAF706900	A/ Folding Walking Frame - Large	610 mm	860 - 935 mm	127 kg	1 Year	AP12
WAF706700K	A/ Folding Walking Frame w/ Wheels & Ski's - Small	610 mm	710 - 787 mm	127 kg	1 Year	AP12
WAF706800K	A/ Folding Walking Frame w/ Wheels & Ski's - Medium	610 mm	787 - 860 mm	127 kg	1 Year	AP12
WAF706900K	A/ Folding Walking Frame w/ Wheels & Ski's - Large	610 mm	860 - 935 mm	127 kg	1 Year	AP12

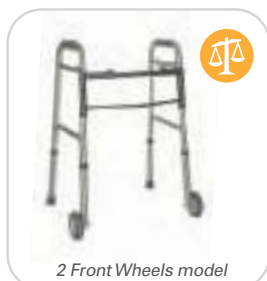

## Heavy Duty Folding Walking Frame

- Heavy Duty Frame for durability
- Folds flat for easy transportation and storage
- Extra wide frame width to suit larger users
- Height adjustable to suit user requirements
- Ferrule of 25mm
- Product weight at 8.3kg

Code	Description	Width	Handle Height	S.W.L	Warranty	DVA:
WAF704745	Heavy Duty Folding Walking Frame	740 mm	810 - 990 mm	227 kg	1 Year	AP12
WAF704750	Heavy Duty Folding Walking Frame with 2 Front Wheels	740 mm	810 - 990 mm	227 kg	1 Year	AP12



## Accessories

Code	Description	DVA:
WAA686450	Wheels for Walking Frame (pair)	AP21
WAA686540	Two Piece Ski 25.4 mm (pair)	AP21
WAA686720	Glide - White 25.4 mm, Yellow Dot	-

# Forearm Walkers



For NDIS Item Code, refer to page: 508



## Aspire Vogue Forearm Seat Walker



Luxury Look & Feel

European Made

Lockable Handbrakes



Smart Posture System

Height, angle and depth adjustable forearm supports achieve optimal centre of gravity for improved balance and weight distribution



Smooth Height Adjustment with AUTOLOCATE



Locks when Folded

220mm folding width minimises storage space



User Comfort



Super-soft wheels and padded forearm surfaces absorb bumps and jolts creating a smooth, comfortable ride

Rehab Focus

Easy to push with a small turning circle



Robust 8" TPE Super Soft Rubber Wheels



White



Code	Description	Overall Height	Overall Length	Overall Width	Folded Width	Seat Depth	Seat Width	Seat Height	Wheel Size	Total Weight	Bag S.W.L	DVA:
WAF705400	Vogue Forearm Walker - White	1020 - 1270 mm	660 mm	620 mm	225 mm	240 mm	460 mm	620 mm	8"	9 kg	5 kg	AP12

Mobility Walking Frames & Aids

### General Enquiries

P 1300 133 120 | E sales@aidacare.com.au | W www.aidacare.com.au

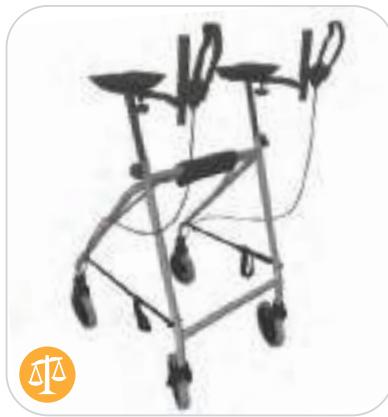

## Aspire Walking Tutor HD with Brakes

- Provides assistance for those who have difficulty walking
- For users who have limited hand or wrist strength, can weight bear through forearms
- Unique lightweight (5kg) folding design for storage or transportation (300 x 640mm)
- Adjustable hand grips to suit user forearm length
- Height adjustable forearm supports to suit user requirements
- Swivel wheels for manoeuvrability
- Powder coated mild steel construction
- Skis available as an option instead of rear rubber tips

Code	Description	Forearm Pad Height	Overall Length	Overall Width	Folded Length	Brake Handle Length	Wheel Size	Product Weight	SWL	DVA:
WAF699200	Walking Tutor Forearm Gutter Frame - HD / Brakes	1010 - 1200 mm	790 mm	640 mm	280 mm	450 - 520 mm	7.5"	16 kg	180 kg	AP12



## Forearm Gutter Walking Frame

- Provides assistance for those who have difficulty walking
- For users who have limited hand or wrist strength, can weight bear through forearms
- Unique lightweight (5kg) folding design for storage or transportation (300 x 640mm)
- Adjustable hand grips to suit user forearm length
- Height adjustable forearm supports to suit user requirements
- Swivel wheels for manoeuvrability
- Powder coated mild steel construction
- Skis available as an option instead of rear rubber tips

Code	Description	Front Width	Rear Width	Depth	Height of Forearm Support	S.W.L	Warranty	DVA:
WAF705950	Forearm Gutter Walking Frame	400 mm	600 mm	680 mm	930 - 1230 mm	110 kg	1 Year	AP12

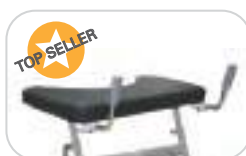

Large Heavy Duty Model

## Walking Tutor Forearm Gutter Frame

- Provides assistance for those who have difficulty walking
- Tutors the user into an upright gait
- Folding design for storage or transportation
- Height adjustable forearm supports to suit user requirements
- Adjustable hand grips to suit user forearm length
- Four swivel wheels for manoeuvrability
- Powder coated mild steel construction
- Skis or glides available as an option as well as padded chest rest

Code	Description	Depth	Height of Forearm Support	S.W.L	Warranty	DVA:
WAF704400	Walking Tutor - Child	410 mm	600 - 790 mm	60 kg	1 Year	-
WAF704500	Walking Tutor - Child w/ Glides	410 mm	600 - 790 mm	60 kg	1 Year	-
WAF704600	Walking Tutor - Child w/ Padded Chest Rest	410 mm	600 - 790 mm	60 kg	1 Year	-
WAF709200	Walking Tutor - Junior	495 mm	670 - 960 mm	80 kg	1 Year	AP12
WAF709300	Walking Tutor - Junior w/ Glides	495 mm	670 - 960 mm	80 kg	1 Year	AP12
WAF709400	Walking Tutor - Junior w/ Padded Chest Rest	495 mm	670 - 960 mm	80 kg	1 Year	AP12
WAF708900	Walking Tutor - Adult	515 mm	850 - 1350 mm	100 kg	1 Year	AP12
WAF709000	Walking Tutor - Adult w/ Glides	515 mm	850 - 1350 mm	100 kg	1 Year	AP12
WAF709100	Walking Tutor - Adult w/ Padded Chest Rest	515 mm	850 - 1350 mm	100 kg	1 Year	AP12
WAF709150	Walking Tutor - Adult Heavy Duty	900 mm	850 - 1350 mm	175 kg	1 Year	-

### DVA Contact Details

P 1300 888 052 | F 1300 787 052 | E [dva@aidacare.com.au](mailto:dva@aidacare.com.au)



For NDIS Item Code, refer to page: 508



# Walking Sticks



For NDIS Item Code, refer to page: 508



## Folding Walking Stick

- Conveniently snaps open in seconds and folds away into a small bag
- Polished hardwood handle and matte black aluminium stick

Code	Description	Handle Height	Ferrule	Product Weight	S.W.L	Warranty	DVA:
WAS744700	Folding Walking Stick	787 - 900 mm	18 mm	400 g	100kg	1 Year	AP13



## T Handle Walking Stick

- Adjustable height to suit user
- Polished hardwood handle and matte black aluminium stick

Code	Description	Handle Height	Ferrule	Product Weight	S.W.L	Warranty	DVA:
WAS743600	T Handle W/Stick	715 - 970 mm	18 mm	365 g	100kg	1 Year	AP13



## Swan Neck Walking Stick with Strap

- Adjustable height to suit user
- Aluminium stick with unique foam swan handle for maximum comfort and strap for added security

Code	Description	Handle Height	Ferrule	Product Weight	S.W.L	Warranty	DVA:
WAS743700	Swan Walking Stick with Strap	730 - 985 mm	18 mm	365 g	100 kg	1 Year	AP13
WAS743800	T Handle Swan Walking Stick Adjustable	710 - 965 mm	22 mm	550 g	127 kg	1 Year	AP13
WAS744750	Bariatric Walking Stick	737 - 966 mm	28 mm	400 g	225 kg	1 Year	AP13



### General Enquiries

P 1300 133 120 | E sales@aidacare.com.au | W www.aidacare.com.au



## Walking Stick Palm Grip

- Unique, biometrically shaped handle designed to evenly spread pressure across the palm of the hand
- Very useful for those with arthritis or poor grip
- Right and left hand available

Code	Description	Handle Height	Ferrule	Product Weight	S.W.L	Warranty	DVA:
WAS744300	Walking Stick Palm Right Grip	670 - 925 mm	18 mm	400 g	127 kg	1 Year	AP13
WAS744400	Walking Stick Palm Left Grip	670 - 925 mm	18 mm	400 g	127 kg	1 Year	AP13



## Quad Base Walking Stick

- Adjustable height to suit user
- Four point base for extra stability
- Soft foam hand grip

Code	Description	Handle Height	Base Measurement	Ferrule	Product Weight	S.W.L	Warranty	DVA:
WAS744600	Walking Stick Quad Small Base	1170 - 1630 mm	200 x 150 mm	12.5 mm	1 kg	113 kg	1 Year	AP06
WAS744500	Walking Stick Quad Large Base	1470 - 1930 mm	300 x 200 mm	15.6 mm	1.2 kg	113 kg	1 Year	AP06

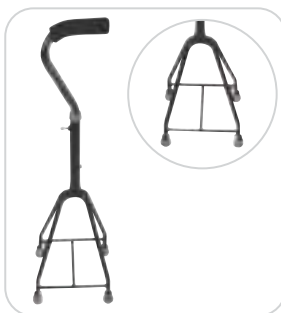

## Pyramid Walking Stick

- Adjustable height to suit user
- Pyramid base for extra stability
- Soft foam hand grip

Code	Description	Handle Height	Base Measurement	Product Wt.	S.W.L	Warranty	DVA:
WAS743900	Walking Stick Pyramid	790 - 990 mm	240 x 300 mm	800 g	100 kg	1 Year	AP06



## Walking Stick with Folding Seat

- Lightweight aluminium walking stick that has a built in seat
- Ideal for resting when out and about
- Compact design allows the seat to be folded up when not in use

Code	Description	Handle Height	Product Weight	Seat Height	S.W.L	Warranty
WAS744000	Walking Stick with Folding Seat	870 mm	365 g	546 mm	113kg	1 Year



## Crook Handle Walking Stick

- Adjustable height to suit user
- Comfortable crook handle covered in foam for comfort

Code	Description	Handle Height	Ferrule	Product Weight	S.W.L	Warranty	DVA:
WAS744200	Walking Stick Aluminium with Crook Handle	762 - 991 mm	18 mm	400 g	113kg	1 Year	AP13

# Crutches



For NDIS Item Code, refer to page: 508



## Forearm Crutches

- Lightweight (600g each) and durable forearm crutches to suit a large range of users
- Cuff provides a secure fitting to the forearm
- Adjustable height between cuff and handle & handle and ground
- 22mm ferrules

Code	Description	User Height	Crutch Height	S.W.L	Warranty	DVA:
WAC692000	Forearm Crutches Youth - Small	1230 - 1640 mm	530 - 785 mm	180 kg	1 Year	AP03
WAC691400	Forearm Crutches Adult - Medium	1480 - 1860 mm	635 - 910 mm	180 kg	1 Year	AP03
WAC691800	Forearm Crutches Adult - Tall Large	1740 - 2040 mm	820 - 1075 mm	180 kg	1 Year	AP03



## Forearm Crutches Ergonomic

- Ergonomic shaped handle distributes the pressure more evenly across the hand
- Lightweight (715g each) and durable forearm crutches to suit a large range of users
- Cuff provides a secure fitting to the forearm
- Adjustable height between cuff and handle & handle and ground
- 22mm ferrules

Code	Description	Total Height	Crutch Height	S.W.L	Warranty	DVA:
WAC691500	Forearm Crutches Ergonomic - Medium	1585 - 1800 mm	580 - 835 mm	127 kg	1 Year	AP03
WAC691900	Forearm Crutches Ergonomic - Large	1706 - 2010 mm	680 - 935 mm	127 kg	1 Year	AP03



## Forearm Crutches (Custom)

- Reinforced aluminium construction (800g each) designed for users with long term needs
- Absence of adjustment holes makes the crutch "silent" in use
- Supplied in one standard length and may be cut to the required length
- Please specify handle to floor height at time of order
- 22mm ferrules

Code	Description	Cuff to Handle	Handle to Floor	S.W.L	Warranty	DVA:
WAC688400	Forearm Crutches Custom	229 mm	(Custom)	190 kg	1 Year	AP03



## Kids Forearm Crutches

- Just for kids
- These light weight yellow Forearm Crutches are height adjustable

Code	Description	Handle Height	Ferrule	S.W.L	Warranty
WAC691700	Crutches Forearm Child 4 - 7 years	406 - 559 mm	18 mm	100 kg	1 Year
WAC691600	Crutches Forearm Child 6 - 10 years	457 - 656 mm	18 mm	100 kg	1 Year



## Underarm Crutches - Red Dot

- Patented clip - lock adjustable handle and push button foot pieces for fast, precise measuring and fitting
- 22mm ferrules
- High density rubber cushions and handgrips providing long wear and greater comfort
- Lightweight aluminium frame, child weighing 1.1kg each, and youth - adult tall weighing 1.25kg each

Code	Description	User Height	Crutch Height	S.W.L	Warranty	DVA:
WAC692300	Underarm Crutches - Child	1220 - 1370 mm	787 - 940 mm	136 kg	1Year	-
WAC692500	Underarm Crutches - Youth	1320 - 1570 mm	940 - 1140 mm	136 kg	1Year	AP03
WAC692200	Underarm Crutches - Adult	1550 - 1750 mm	1120 - 1320 mm	136 kg	1Year	AP03
WAC692400	Underarm Crutches - Adult Tall	1780 - 1980 mm	1320 - 1520 mm	136 kg	1Year	AP03



## Underarm Crutches Bariatric

- Designed with strength to support the bariatric user
- Steel construction provides durability and support up to 249 kg
- Lightweight frame weighing 4.7kg
- 22mm ferrule

Code	Description	User Height	Crutch Height	S.W.L	Warranty	DVA:
WAC688300	Underarm Crutches - Bariatric Adult	1575 - 1778 mm	1120 - 1320 mm	249 kg	1Year	AP03
WAC688200	Underarm Crutches - Bariatric Adult Tall	1778 - 1981 mm	1320 - 1520 mm	249 kg	1Year	AP03



## Underarm Crutches - Wing Nut

- Easy to use Wing-Nut height adjustment
- High density rubber cushions and handgrips providing long wear and greater comfort
- Lightweight aluminium frame
- 22mm ferrules

Code	Description	User Height	Crutch Height	S.W.L	Warranty	DVA:
WAC692503	Underarm Crutches Youth - Small	1370 - 1575 mm	940 - 1145 mm	136 kg	1Year	AP03
WAC692502	Underarm Crutches - Medium	1575 - 1778 mm	1120 - 1320 mm	136 kg	1Year	AP03
WAC692501	Underarm Crutches Adult - Tall	1778 - 1980 mm	1350 - 1520 mm	136 kg	1Year	AP03



## Crutch Cushion

- Replacement Axilla Cushion for Underarm Crutches



## Crutch - Hand Grip

- Replacement Cushion handle to suit Underarm Crutches

Code	Description	DVA:
WAA686240	Crutch Grey Axilla Cushion - Red Dot	AP2
WAA686245	Crutch Padding Axilla Cushion - Wing Nut Crutches	AP21
WAA686250	Crutch Grey Axilla Bariatric Cushion	AP21

Code	Description	DVA:
WAA686220	Crutch Grey Hand Grip Padding - Red Dot	AP21
WAA686225	Crutch Padding Grey Hand Grip - Wing Nut Crutches	AP21
WAA686230	Crutch Grey Hand Grip Bariatric	AP21



## Gutter Crutches

- Ideal for those with limited hand or wrist strength
- Lightweight tubular aluminium stem and padded vinyl covered gutter for maximum comfort
- Designed for users with arthritis or an impaired grip
- Forearm trough distributes a user's weight over a large support area
- Adjustable telescopic handle rotates through 360° and locks to suit individual forearm length

Code	Description	Gutter Height	Ferrule	Product Weight	S.W.L	Warranty	DVA:
WAC694200	Gutter Crutches	980 - 1235 mm	25 mm	950g (each)	127 kg	1Year	AP03

# General Accessories



For NDIS Item Code, refer to page: 508



## Ferrules/Rubber Tips

- High quality rubber ferrule tips suitable for use with walking frames, crutches, walking sticks and quad sticks



## Glides

- Alternative to the rubber stoppers commonly used on the rear legs of aluminium folding walking frames
- Helps the frame to slide easily indoors
- Sold as each

Code	Description	DVA:
WAA686280	Rubber Ferrule 13 mm, Black	AP21
WAA686290	Rubber Ferrule 16 mm, Black	AP21
WAA686300	Rubber Ferrule 16 mm, Grey	AP21
WAA686310	Rubber Ferrule 18 mm, Grey	AP21
WAA686332	Rubber Ferrule 18 mm, Black	AP21
WAA686320	Rubber Ferrule 22 mm, Grey	AP21
WAA686330	Rubber Ferrule 25 mm, Grey	AP21

Code	Description
WAA686690	Glide White 19 mm, Black Dot
WAA686700	Glide White 22.2 mm, Green Dot
WAA686710	Glide White 25 mm, Red Dot
WAA686720	Glide White 25.4 mm, Yellow Dot
WAA686730	Glide White 28.6 mm, Blue Dot



## Ski's

- Alternative to the rubber stoppers commonly used on the rear legs of rollator-style walking frames
- Helps the frame to slide easily indoors, easily attached



## Wheels

- These light weight front castor wheels are designed to suit the Aluminium Walking Frame and Aluminium Walking Frame Folding

Code	Description	DVA:
WAA686530	Two Piece Ski 22.2 mm (pair)	AP21
WAA686540	Two Piece Ski 25.4 mm (pair)	AP21
WAA686550	Two Piece Ski 28.6 mm (pair)	AP21

Code	Description	DVA:
WAA686450	Walking Frame Wheels (pair)	AP21

### General Enquiries

P 1300 133 120 | E sales@aidacare.com.au | W www.aidacare.com.au



# Mobility Wheelchairs & Positioning



## Contents

- P 272** Aspire Manual Wheelchairs
- P 278** Aspire Wheelchair Accessories
- P 282** Other Manual Wheelchairs
- P 286** Standard Power Wheelchairs  
(Complex Rehab Configurable Wheelchairs)
- P 288** Sunrise Medical Power & Manual  
Wheelchairs
- P 290** Permobil Power Wheelchairs
- P 291** Tilite Manual Wheelchairs
- P 292** Quantum Power Wheelchairs
- P 293** Ottobock Power & Manual  
Wheelchairs
- P 294** Invacare Power & Manual  
Wheelchairs
- P 295** Wheelchair Backrests
- P 306** General Wheelchair Accessories

# Aspire Manual Wheelchairs



For NDIS Item Code, refer to page: 508



Brochures also available. Please contact us for a copy.

## Aspire Evoke 2 Wheelchair



Seat & Backrest Height Adjustable

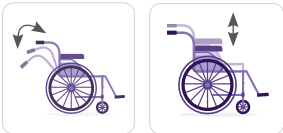

Customisable Backrest

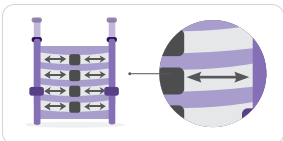

Seat Depth Adjustable



Height and angle adjustable front castors 8"



Folding Lightweight Aluminium Design

Height adjustable back canes 17" - 19"

Optional Contoured Padded Overlay



Swing-back armrests  
(Height and depth adjustable option available)

Swing away and removable legrests

Height and angle adjustable footrests

Quick release 24" solid rear wheels



Frame



Components



Code	Description	Seat Width	Overall Width	Seat Depth	Seat Height	Backrest Height	Armrest Height	Min. Chair Weight	DVA:
MWS449500	Evoke 2 - 350 mm (14")	350 mm (14")	560 mm	400 - 475 mm	440 - 480 mm	430 - 490 mm	205 - 225 mm	From 14.8 kg	AP17
MWS449510	Evoke 2 - 400 mm (16")	400 mm (16")	610 mm	400 - 475 mm	440 - 480 mm	430 - 490 mm	205 - 225 mm	From 14.9 kg	AP17
MWS449520	Evoke 2 - 450 mm (18")	450 mm (18")	660 mm	400 - 475 mm	440 - 480 mm	430 - 490 mm	205 - 225 mm	From 15.0 kg	AP17
MWS449530	Evoke 2 - 500 mm (20")	500 mm (20")	710 mm	400 - 475 mm	440 - 480 mm	430 - 490 mm	205 - 225 mm	From 15.1 kg	AP17

Mobility Wheelchairs & Positioning



## Aspire Evoke 2 HD Wheelchair



Seat & Backrest Height Adjustable



Customisable Backrest

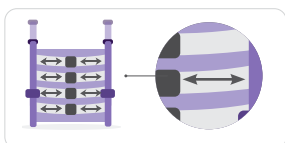

Seat Depth Adjustable

Height and angle adjustable front castors 8"



Folding Lightweight Aluminium Design

Height adjustable back canes 17" - 19"

Optional Contoured Padded Overlay

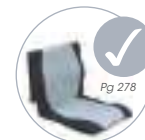

Swing-back armrests  
*(Height and depth adjustable option available)*

Swing away and removable legrests

Height and angle adjustable footrests

Quick release 24" solid rear wheels



Frame

Components

Code	Description	Seat Width	Overall Width	Seat Depth	Seat Height	Backrest Height	Armrest Height	Min. Chair Weight	DVA:
MWS449540	Evoke 2 (HD) - 570 mm (22")	570 mm (22")	780 mm	400 - 475 mm	440 - 480 mm	430 - 490 mm	205 - 225 mm	From 16.0 kg	AP17
MWS449550	Evoke 2 (HD) - 610 mm (24")	610 mm (24")	820 mm	400 - 475 mm	440 - 480 mm	430 - 490 mm	205 - 225 mm	From 16.2 kg	AP17

## Aspire Evoke 2 JNR Wheelchair



Folding Lightweight Design

Height adjustable and removable armrests

Seat & Backrest Height Adjustable



Seat Depth Adjustable



Customisable Backrest

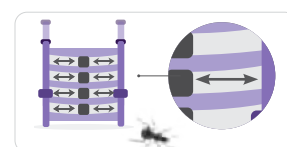

Easy Access Push-to-lock Brakes

Height & Angle Adjustable 8" Castors

Quick Release, Solid 20" Tyres



Frame

Components

Code	Description	Seat Width	Overall Width	Seat Depth	Seat Height	Backrest Height	Armrest Height	Min. Chair Weight
MWS449560	Evoke 2 JNR	300 mm (12")	510 mm	300 - 375 mm	360 - 410 mm	430 - 490 mm	205 - 225 mm	14 kg

For Aspire Wheelchair Accessories Range See Page 278

### DVA Contact Details

P 1300 888 052 | F 1300 787 052 | E [dva@aidacare.com.au](mailto:dva@aidacare.com.au)



For NDIS Item Code, refer to page: 508







### Aspire Assist 2 Wheelchair



Folding Steel Frame

Optional Contoured Padded Overlay



Quick Release Solid 24" Rear Wheels

Height Adjustable, 8" Castors



Dacron Fire Retardant Fabric

Swing-back Removable Armrests

Push-to-lock Brakes

Removable Swing Away Legrests  
(Elevating / Articulating optional accessory)



Height Adjustable Footrest

2  
Year  
Warranty

1  
Year  
Warranty

**S.W.L**  
**140kg**

Frame

Components

Code	Description	Seat Width	Overall Width	Seat Depth	Seat Height	Backrest Height	Armrest Height	Min. Chair Weight	DVA:
MWS449300	Assist 2 - 350 mm (14")	350 mm (14")	570 mm	400 mm	460 - 500 mm	440 mm	210 mm	17.3 kg	AP17
MWS449310	Assist 2 - 400 mm (16")	400 mm (16")	620 mm	400 mm	460 - 500 mm	440 mm	210 mm	17.5 kg	AP17
MWS449320	Assist 2 - 450 mm (18")	450 mm (18")	670 mm	400 mm	460 - 500 mm	440 mm	210 mm	17.7 kg	AP17
MWS449330	Assist 2 - 500 mm (20")	500 mm (20")	720 mm	400 mm	460 - 500 mm	440 mm	210 mm	17.9 kg	AP17

### Aspire Assist 2 WARD Wheelchair



Swing-back Removable Armrests

Folding Steel Frame



Push-to-lock Brakes

Quick Release Solid 24" Rear Wheels  
& Height Adjustable 8" Castors



Hospital Grade Vinyl, Infection Control Compliant



Removable Swing Away Legrests  
(Elevating / Articulating optional accessory)



Height Adjustable Footrest

2  
Year  
Warranty

1  
Year  
Warranty

**S.W.L**  
**140kg**

**S.W.L**  
**180kg**

Frame

Components

Assist 2

Assist 2 HD

**SECURITY MODIFICATION:**  
Simple Frame Fix to Stop  
Chair Being Folded  
(Available as option on request)

Code	Description	Seat Width	Overall Width	Seat Depth	Seat Height	Backrest Height	Armrest Height	Min. Chair Weight	DVA:
MWS449340	Assist 2 WARD - 350 mm (14")	350 mm (14")	570 mm	400 mm	460 - 500 mm	440 mm	210 mm	17.4 kg	AP17
MWS449350	Assist 2 WARD - 400 mm (16")	400 mm (16")	620 mm	400 mm	460 - 500 mm	440 mm	210 mm	17.6 kg	AP17
MWS449360	Assist 2 WARD - 450 mm (18")	450 mm (18")	670 mm	400 mm	460 - 500 mm	440 mm	210 mm	17.8 kg	AP17
MWS449370	Assist 2 WARD - 500 mm (20")	500 mm (20")	720 mm	400 mm	460 - 500 mm	440 mm	210 mm	18 kg	AP17
MWS449380	Assist 2 WARD (HD) - 570 mm (22")	570 mm (22")	790 mm	400 mm	460 - 500 mm	440 mm	210 mm	18.9 kg	AP17
MWS449390	Assist 2 WARD (HD) - 610 mm (24")	610 mm (24")	830 mm	400 mm	460 - 500 mm	440 mm	210 mm	19.2 kg	AP17

#### General Enquiries

P 1300 133 120 | E sales@aidacare.com.au | W www.aidacare.com.au



### Aspire Transit 2 Wheelchair



Folding Steel Frame

Padded Nylon Upholstery

Optional Contoured Padded Overlay



Quick Release Solid 12" Rear Wheels & Height Adjustable 8" Castors



Dacron Fire Retardant Fabric

Swing-Away, Removable Armrests



Attendant Push-to-lock Brakes

Removable Swing Away Legrests & Height Adjustable Footrest  
*(Elevating /Articulating optional accessory)*

**2**  
Year  
Warranty

**1**  
Year  
Warranty

**S.W.L**  
**140kg**

Frame

Components

Code	Description	Seat Width	Overall Width	Seat Depth	Seat Height	Backrest Height	Armrest Height	Min. Chair Weight	DVA:
MWS449410	Transit 2 - 400 mm (16")	400 mm (16")	540 mm	400 mm	460 - 500 mm	440 mm	210 mm	16.4 kg	AP17
MWS449420	Transit 2 - 450 mm (18")	450 mm (18")	590 mm	400 mm	460 - 500 mm	440 mm	210 mm	16.6 kg	AP17
MWS449430	Transit 2 - 500 mm (20")	500 mm (20")	640 mm	400 mm	460 - 500 mm	440 mm	210 mm	16.8 kg	AP17

### Aspire Rehab RS Wheelchair *Low - Medium Level Rehabilitation*



Attendant Operated Drum Brakes & Push-to-lock Handbrakes



Removable, Height & Depth Adjustable Armrest

Tilt-in-Space Functionality



**25°**  
TILT

**30°**  
RECLINE



Quick Release, Height & Depth Adjustable Solid 24" Rear Wheels & Height Adjustable 6" Castors



Height, Depth, Angle & Width Adjustable Removable Headrest

Depth Adjustable Seat, Height & Depth Adjustable Backrest

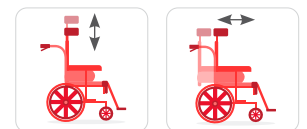

Swing-away, Removable, Padded & Elevating Legrest



Height & Angle Adjustable Footrest

**2**  
Year  
Warranty

**1**  
Year  
Warranty

**S.W.L**  
**180kg**

Frame

Components

Code	Description	Seat Width	Overall Width	Seat Depth	Seat Height	Backrest Height	Armrest Height	Min. Chair Weight	DVA:
MWS449600	Rehab RS - 410 to 460 mm (16 - 18")	410 - 460 mm (16" - 18")	690 mm	440 - 530 mm	Front = 410 - 440 mm Rear = 400 - 475 mm	460 - 710 mm	310 - 460 mm	40.7 kg	AP17
MWS449610	Rehab RS - 460 to 510 mm (18 - 20")	460 - 510 mm (18" - 20")	740 mm	440 - 530 mm	Front = 410 - 440 mm Rear = 400 - 475 mm	460 - 710 mm	310 - 460 mm	42.5 kg	AP17
MWS449620	Rehab RS - 510 to 560 mm (20 - 22")	510 - 560 mm (20" - 22")	790 mm	470 - 560 mm	Front = 410 - 440 mm Rear = 400 - 475 mm	460 - 710 mm	310 - 460 mm	46.7 kg	AP17

#### DVA Contact Details

P 1300 888 052 | F 1300 787 052 | E [dva@aidacare.com.au](mailto:dva@aidacare.com.au)



For NDIS Item Code, refer to page: 508





### Aspire Rehab RX Wheelchair *High Level Rehabilitation*



#### What Sets the Aspire RX apart?

- Advanced articulating legrests
- Increased contouring on the backrest to encourage midline sitting
- Adductor and abductor build up on the cushion for optimal lower limb positioning

Removable, Height & Depth Adjustable Armrest

Tilt-in-Space Functionality



Quick Release, Height & Depth Adjustable Solid 24" Rear Wheels & Height Adjustable 6" Castors

Height & Angle Adjustable Footrest



Height, Depth, Angle & Width Adjustable Removable Headrest

Attendant Operated Drum Brakes & Push-to-lock Handbrakes

Depth Adjustable Seat, Height & Depth Adjustable Backrest

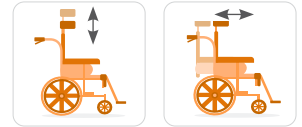

Swing-away, Removable, Padded & Elevating Articulating Legrest



**2**  
Year  
Warranty

**1**  
Year  
Warranty

**S.W.L**  
**180kg**

Frame

Components

Code	Description	Seat Width	Overall Width	Seat Depth	Seat Height	Backrest Height	Armrest Height	Min. Chair Weight	DVA:
MWS449710	Rehab RX - 410 - 460 mm (16 - 18")	410 - 460 mm (16" - 18")	690 mm	440 - 530 mm	Front = 410 - 440 mm Rear = 400 - 475 mm	460 - 710 mm	310 - 460 mm	41 kg	AP17
MWS449720	Rehab RX - 460 - 510 mm (18 - 20")	460 - 510 mm (18" - 20")	740 mm	440 - 530 mm	Front = 410 - 440 mm Rear = 400 - 475 mm	460 - 710 mm	310 - 460 mm	43 kg	AP17
MWS449740	Rehab RX - 510 - 560 mm (20 - 22")	510 - 560 mm v(20" - 22")	790 mm	470 - 560 mm	Front = 410 - 440 mm Rear = 400 - 475 mm	460 - 710 mm	310 - 460 mm	47.2 kg	AP17

### Aspire Rehab RX JNR Wheelchair



Attendant Operated Drum Brakes & Push-to-lock Handbrakes



Removable, Height & Depth Adjustable Armrest

Tilt-in-Space Functionality

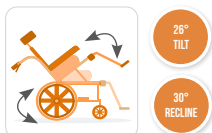

Quick Release, Height & Depth Adjustable Solid 20" Rear Wheels & Height Adjustable 6" Castors



Height, Depth, Angle & Width Adjustable Removable Headrest

Depth Adjustable Seat, Height & Depth Adjustable Backrest

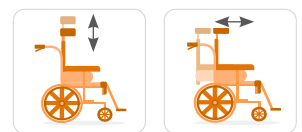

Swing-away, Removable, Padded & Elevating Articulating Legrest



Height & Angle Adjustable Footrest

**2**  
Year  
Warranty

**1**  
Year  
Warranty

**S.W.L**  
**180kg**

Frame

Components

Code	Description	Seat Width	Overall Width	Seat Depth	Seat Height	Backrest Height	Armrest Height	Min. Chair Weight
MWS449630	Rehab RX JNR	320 - 370 mm (13" - 15")	600 mm	440 - 490 mm	Front = 410 - 440 mm Rear = 400 - 475 mm	460 - 710 mm	310 - 460 mm	39.5 kg

#### General Enquiries

P 1300 133 120 | E sales@aidacare.com.au | W www.aidacare.com.au



## Aspire Lite Transit Wheelchair



Attendant Operated Brakes



Ultra Light Folding Frame



12" Rear Wheels



Height Adjustable Armrests



Safety Lap Belt



Height Adjustable Legrests



**2**  
Year  
Warranty

**1**  
Year  
Warranty

**S.W.L**  
**120kg**

Frame

Components

Code	Description	Seat Width	Overall Width	Seat Depth	Seat Height	Backrest Height	Armrest Height	Min. Chair Weight	DVA:
MWS442301	Lite Transit	460 mm (18")	600 mm	400 mm	460 mm	465 mm	235 mm	11.6 kg	AP17

## Aspire Lite Wheelchair



Ergonomic Push Handles



Ultra Light Folding Frame



12" Rear Wheels



Height Adjustable Armrests



Safety Lap Belt



Height Adjustable Legrests



**2**  
Year  
Warranty

**1**  
Year  
Warranty

**S.W.L**  
**120kg**

Frame

Components

Code	Description	Seat Width	Overall Width	Seat Depth	Seat Height	Backrest Height	Armrest Height	Min. Chair Weight	DVA:
MWS442300	Lite	460 mm (18")	550 mm	400 mm	460 mm	465 mm	235 mm	9.5 kg	AP17

# Aspire Wheelchair Accessories



For NDIS Item Code, refer to page: 508



## Aspire Contoured Padded Overlay

- Offers the user increased comfort and is ideal for those who are in their wheelchair for longer periods of time
- Suits Aspire wheelchairs as well as many other brands within the market

Code	Description
WCA848330	350 mm
WCA848340	400 mm
WCA848350	450 mm
WCA848360	500 mm
WCA848370	570 mm
WCA848380	610 mm



Look out for this icon on compatible Wheelchairs!



## Aspire Articulating Elevating Legrests

- Padded legrests mirror the anatomical range of movement of the knee joint, ensuring thighs don't elevate as legs are raised

Code	Description
WCA848160	Left - 300/320/350/400/410 mm
WCA848170	Right - 300/320/350/400/410 mm
WCA848180	Left - 450/460/500/510 mm
WCA848190	Right - 450/460/500/510 mm
WCA848200	Left - 570/610 mm
WCA848210	Right - 570/610 mm

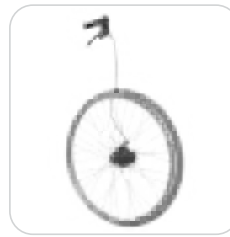

## Aspire Drum Brake Kit

- This upgrade kit can be retrofitted to the Evoke 2, Evoke Jnr, Rehab RX, Rehab RX Jnr and the Rehab RS providing the attendant with more control on sloped surfaces

Code	Description
WCA848500	Rear Wheels w/Drum Brakes Kit - 24in
WCA848510	Rear Wheels w/Drum Brakes Kit - 16in
WCA848520	Rear Wheels w/Drum Brakes Kit - 20in



## Aspire Gutter Armrests

- Provides extra support for users with weak or unsupported arms

Code	Description
WCA848410	Gutter Armrest Pad - Left
WCA848420	Gutter Armrest Pad - Right



## Aspire Brake Extension Levers

- Extends brake lever for user accessibility

Code	Description
WCA848310	Extension Lever - Left
WCA848320	Extension Lever - Right



## Aspire Safety Lap Belt

- Suitable for supporting users with low tone or weakness
- Metal push button for secure fit

Code	Description
WCA848300	Metal Seatbelt Buckle



## Aspire Camber Kit

- Tilts the rear wheels to improve lateral stability

Code	Description
WCA848490	Camber Kit

### General Enquiries

P 1300 133 120 | E sales@aidacare.com.au | W www.aidacare.com.au

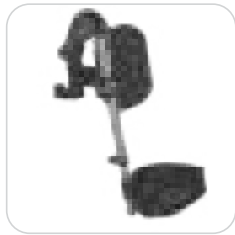

### Aspire Elevating Legrest

- Elevating padded legrests for improved user comfort

Code	Description
WCA848100	Left - 300/320/350/400/410 mm
WCA848110	Right - 300/320/350/400/410 mm
WCA848120	Left - 450/460/500/510 mm
WCA848130	Right - 450/460/500/510 mm
WCA848140	Left - 570/610 mm
WCA848150	Right - 570/610 mm



### Aspire Stump Support

- For Amputee Support

Code	Description
WCA848220	Left - 300/320/350/400/450 mm
WCA848230	Right - 300/320/350/400/450 mm
WCA848240	Left - 500/550/570/610 mm
WCA848250	Right - 500/550/570/610 mm
WCA848260	Extension Bracket



### Aspire Base Frame Extension Kits

- Extends stump support to cater for taller users

Code	Description
WCA848530	50 mm - Black
WCA848540	100 mm - Black



### Aspire Depth & Height Adjustable Armrests

- Provides multiple support positions for users arms

Code	Description
WCA848390	Adjustable Armrest - Left
WCA848400	Adjustable Armrest - Right

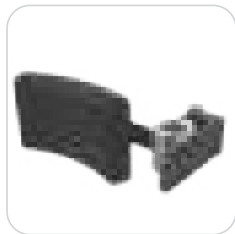

### Aspire Lateral Chest Support

- Facilitates postural positioning

Code	Description
WCA848430	Lateral Chest Support - Left
WCA848430	Lateral Chest Support - Right



### Aspire Tool-free Adjustment Kit

- Allows for easy adjustment of a wheelchair

Code	Description
WCA848550	Therapist-Friendly Tool-Free Adjustment Kit



### Aspire Oxygen Bottle Holder

- Holds oxygen bottle in place
- Designed to hold C size bottles

Code	Description
WCA848290	Oxygen Bottle Holder



### Aspire Extended Back Canes

- Extends back canes up-to 50 mm to facilitate easy movement for taller carers

Code	Description
WCA848470	Extended Back Cane - Pair - 19/21in



### Aspire Meal Tray

- Provides a sturdy surface during meal time

Code	Description
WCA848560	MealTray - 320 mm to 410 mm
WCA848570	MealTray - 460 mm to 510 mm



### Aspire IV Pole

- Facilitates intravenous infusion

Code	Description
WCA848280	IV Pole

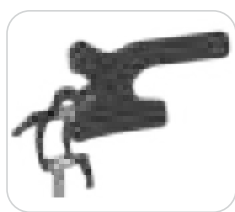

### Aspire Deluxe Headrest

- Angle adjustable head support
- Promotes user posture and comfort

Code	Description
WCA848480	Headrest Assembly - Deluxe Style

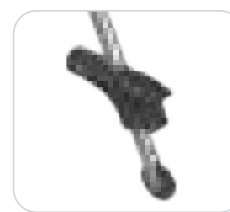

### Aspire Anti-tip Bars

- Ensures chair does not tilt over when traveling across inclines and uneven surfaces

Code	Description
WCA848270	Anti-Tip Bars



### Aspire Oxygen Bottle Bag

- Holds oxygen bottle in place
- Designed to hold C size bottles

Code	Description
WAA695600	Oxygen Bottle Bag

















### Aspire Calf Strap

- Provides extra support for users calves

Code	Description
WCA848580	Calf Strap



CODE	DESCRIPTION	SUITS						
		 Evoke 2	 Evoke 2 JNR	 Rehab RX JNR	 Rehab RX	 Rehab RS	 Assist 2	 Transit 2
<b>ELEVATING LEGRESTS</b>								
WCA848100	Elevating Legrest - Left - 300/320/350/400/410 mm 	●	●	●	●	○	●	●
WCA848110	Elevating Legrest - Right - 300/320/350/400/410 mm	●	●	●	●	○	●	●
WCA848120	Elevating Legrest - Left - 450/460/500/510 mm	●			●	○	●	●
WCA848130	Elevating Legrest - Right - 450/460/500/510 mm	●			●	○	●	●
WCA848140	Elevating Legrest - Left - 570/610 mm	●					●	
WCA848150	Elevating Legrest - Right - 570/610 mm	●					●	
<b>ADVANCED ARTICULATING ELEVATING LEGRESTS</b>								
WCA848160	Elevating Legrest - Articulating - Left - 300/320/350/400/410 mm	●	●	○	○	●	●	●
WCA848170	Elevating Legrest - Articulating - Right - 300/320/350/400/410 mm	●	●	○	○	●	●	●
WCA848180	Elevating Legrest - Articulating - Left - 450/460/500/510 mm	●			○	●	●	●
WCA848190	Elevating Legrest - Articulating - Right - 450/460/500/510 mm	●			○	●	●	●
WCA848200	Elevating Legrest - Articulating - Left - 570/610 mm 	●					●	
WCA848210	Elevating Legrest - Articulating - Right - 570/610 mm	●					●	
<b>STUMP SUPPORTS</b>								
WCA848220	Stump Support - Left - Silver - 300/320/350/400/450 mm	●	●	●	●	●	●	●
WCA848230	Stump Support - Right - Silver - 300/320/350/400/450 mm	●	●	●	●	●	●	●
WCA848240	Stump Support - Left - Silver - 500/550/570/610 mm	●			●	●	●	●
WCA848250	Stump Support - Right - Silver - 500/550/570/610 mm 	●			●	●	●	●
WCA848260	Stump Support - Extension Bracket - Silver	●	●				●	●
<b>OXYGEN BOTTLE HOLDERS</b>								
WCA848290	Oxygen Bottle Holder 	●	●				●	●
WAA695600	Oxygen Bottle Bag			●	●	●		
<b>BRAKE EXTENSIONS</b>								
WCA848310	Brake Extension Lever - Left 	●	●				●	●
WCA848320	Brake Extension Lever - Right	●	●				●	●
<b>LATERAL SUPPORTS</b>								
WCA848430	Lateral Chest Support Assembly - Left 	●	●					
WCA848440	Lateral Chest Support Assembly - Right 	●	●					

○ - Standard Feature Included

Mobility Wheelchairs & Positioning



CODE	DESCRIPTION	Image	SUITS							
			Evoke 2	Evoke 2 JNR	Rehab RX JNR	Rehab RX	Rehab RS	Assist 2	Transit 2	
<b>CONTOURED PADDED OVERLAYS</b>										
WCA848330	Contoured Padded Overlay - 350 mm Wide		●						●	
WCA848340	Contoured Padded Overlay - 400 mm Wide		●						●	●
WCA848350	Contoured Padded Overlay - 450 mm Wide		●						●	●
WCA848360	Contoured Padded Overlay - 500 mm Wide		●						●	●
WCA848370	Contoured Padded Overlay - 570 mm Wide		●						●	
WCA848380	Contoured Padded Overlay - 610 mm Wide		●						●	
<b>DEPTH &amp; HEIGHT ADJUSTABLE ARMRESTS</b>										
WCA848390	Depth & Height Adjustable Armrest - Left		●							
WCA848400	Depth & Height Adjustable Armrest - Right		●							
<b>GUTTER ARMRESTS</b>										
WCA848410	Gutter Armrest Pad - Left		●							
WCA848420	Gutter Armrest Pad - Right		●							
<b>DRUM BRAKES</b>										
WCA848510	Rear Wheels w/Drum Brakes Kit - 16in			●	●	●	●			
WCA848520	Rear Wheels w/Drum Brakes Kit - 20in			●	○	●	●			
WCA848500	Rear Wheels w/Drum Brakes Kit - 24in		●			○	○			
<b>DEPTH EXTENSIONS</b>										
WCA848530	Base Frame Extension Kit - 50 mm - Black					●	●			
WCA848540	Base Frame Extension Kit - 100 mm - Black					●	●			
<b>OTHER</b>										
WCA848550	Therapist-Friendly Tool-Free Adjustment Kit					●	●	●		
WCA848560	Meal Tray - 320 mm to 410 mm					●	●	●		
WCA848570	Meal Tray - 460 mm to 510 mm					●	●	●		
WCA848270	Anti-Tip Bars		●	●	○	○	○		●	●
WCA848280	IV Pole		●	●	●	●	●	●	●	●
WCA848300	Safety Lap Belt - Metal Seatbelt Buckle		●	●	●	●	●	●	●	●
WCA848470	Extended Back Cane - Pair - 19/21in		●	●						
WCA848480	Headrest Assembly - Deluxe Style		●	●						
WCA848580	Calf Strap		●	●	●	●	●	●	●	●
WCA848490	Camber Kit		●	●						
AAL848590	Security Mod - ASSIST 2 WARD Only								●	

○ - Standard Feature Included \*Note: Side transfers not possible when gutter armrests are attached

Mobility Wheelchairs & Positioning

**DVA Contact Details**

P 1300 888 052 | F 1300 787 052 | E [dva@aidacare.com.au](mailto:dva@aidacare.com.au)



For NDIS Item Code, refer to page: 508





# Other Manual Wheelchairs



For NDIS Item Code, refer to page: 508

## Breezy Basix 2

- Folding lightweight chair
- Available in self-propelled or transit
- Adjustable push handle height (+/- 3")
- Available with folding backrest
- Tension adjustable upholstery on backrest
- Swing away legrests as standard
- Drum brake option available (16, 18 & 20")
- 41 - 46cm adjustable seat depth
- Castor angle adjustment 0, 3 & 6 degrees
- Crash tested
- Limited Lifetime Warranty



Code	Description	Colour	Backrest Height	Seat Depth	Seat to Floor Height	Seat Width	Product Weight	S.W.L	DVA:
MWS449097	Basix 20" with 24" Solids	Red	410 - 460 mm	400 - 450 mm	455 - 510 mm	520 mm	14.9 kg	125 kg	-
MWS449108	Basix 16" with 24" Solids	Red	410 - 460 mm	400 - 450 mm	455 - 510 mm	400 mm	14.9 kg	125 kg	-
MWS449114	Basix 18" with 24" Solids	Red	410 - 460 mm	400 - 450 mm	455 - 510 mm	460 mm	14.9 kg	125 kg	-
MWS449106	Basix 16" with 24" Pneumatics	Silver	410 - 460 mm	400 - 450 mm	455 - 510 mm	400 mm	14.9 kg	125 kg	AP17
MWS449113	Basix 18" with 24" Pneumatics	Silver	410 - 460 mm	400 - 450 mm	455 - 510 mm	460 mm	14.9 kg	125 kg	AP17
MWS449115	Basix 18" with 24" Pneumatics	Red	410 - 460 mm	400 - 450 mm	455 - 510 mm	460 mm	14.9 kg	125 kg	-

### General Enquiries

P 1300 133 120 | E sales@aidacare.com.au | W www.aidacare.com.au



Code	Description	Colour	Backrest Height	Seat Depth	Seat to Floor Height	Seat Width	Product Weight	S.W.L	DVA:
MWS449120	Basix 20" with 24" Pneumatics	Silver	410 - 460 mm	400 - 450 mm	455 - 510 mm	520 mm	14.9 kg	125 kg	AP17
MWS449093	Basix 16" with 24" Solids - Height Adjustable Armrest	Silver	410 - 460 mm	400 - 450 mm	455 - 510 mm	400 mm	14.9 kg	125 kg	-
MWS449095	Basix 18" with 24" Solids - Height Adjustable Armrest	Silver	410 - 460 mm	400 - 450 mm	455 - 510 mm	460 mm	14.9 kg	125 kg	-
MWS449099	Basix 20" with 24" Solids - Height Adjustable Armrest	Silver	410 - 460 mm	400 - 450 mm	455 - 510 mm	520 mm	14.9 kg	125 kg	-
MWS449110	Basix 16" with 24" Solids with Rear Wheels & Folding Backrest	Silver	410 - 460 mm	400 - 450 mm	455 - 510 mm	400 mm	14.9 kg	125 kg	AP17
MWS449117	Basix 18" with 24" Solids with Rear Wheels & Folding Backrest	Silver	410 - 460 mm	400 - 450 mm	455 - 510 mm	460 mm	14.9 kg	125 kg	AP17
MWS449122	Basix 20" with 24" Solids with Rear Wheels & Folding Backrest	Silver	410 - 460 mm	400 - 450 mm	455 - 510 mm	520 mm	14.9 kg	125 kg	AP17
MWS449112	Basix 18" with 24" Solids with Drum Brake	Silver	410 - 460 mm	400 - 450 mm	455 - 510 mm	460 mm	14.9 kg	125 kg	-
MWS449119	Basix 20" with 24" Solids with Drum Brake	Silver	410 - 460 mm	400 - 450 mm	455 - 510 mm	520 mm	14.9 kg	125 kg	-
MWS449104	Basix 14" with 12" Transit Wheels with Folding Backrest	Silver	410 - 460 mm	400 - 450 mm	455 - 510 mm	360 mm	14.9 kg	125 kg	-
MWS449111	Basix 16" with 12" Transit Wheels with Folding Backrest	Silver	410 - 460 mm	400 - 450 mm	455 - 510 mm	400 mm	14.9 kg	125 kg	-
MWS449118	Basix 18" with 12" Transit Wheels with Folding Backrest	Silver	410 - 460 mm	400 - 450 mm	455 - 510 mm	460 mm	14.9 kg	125 kg	-
MWS449123	Basix 20" with 12" Transit Wheels with Folding Backrest	Silver	410 - 460 mm	400 - 450 mm	455 - 510 mm	520 mm	14.9 kg	125 kg	-
WCA858014	Stump Support for Basix - Left								AP14
WCA858015	Stump Support for Basix - Right								AP14
WCA858012	Crutch Holder for Breezy Basix								AP14
WCA858016	Elevating Leg-Rests for Breezy Basix								AP14
WCA858020	Tray table for 16" Breezy Basix								AP14
WCA858021	Tray table for 18" Breezy Basix								AP14
WCA858022	Tray table for 20" Breezy Basix								AP14



### Breezy Rubix 2 XL Manual

- Folding lightweight bariatric wheelchair
- Adjustable seat depth 460 - 510mm
- Multiple position axle plate
- Heavy duty tension adjustable backrest
- Crash tested
- Limited Lifetime Warranty



Code	Description	Colour	Seat Width	Seat Depth	Back Height	Product Weight	S.W.L
MWS449130	Rubix 20"	Silver	520 mm	460 - 510 mm	410 - 460 mm	16.8 kg	170 kg
MWS449135	Rubix 22"	Silver	560 mm	460 - 510 mm	410 - 460 mm	16.8 kg	170 kg
MWS449140	Rubix 24"	Silver	600 mm	460 - 510 mm	410 - 460 mm	16.8 kg	170 kg

#### DVA Contact Details

P 1300 888 052 | F 1300 787 052 | E [dva@aidacare.com.au](mailto:dva@aidacare.com.au)



For NDIS Item Code, refer to page: 508





### Heavy Duty & Super HD

- Reinforced wheelchair for bariatric users
- Extra wide seat widths and reinforced construction accommodates larger users
- Moulded composite mag wheels
- Swing-away detachable footrests and removable padded armrests
- Durable chrome-plated steel construction



Code	Description	Colour	Seat Width	Seat Depth	Back Height	Seat to Floor Height	Product Weight	S.W.L	Warranty	DVA:
MWS442910	Wheelchair Folding Std - Heavy Duty 20" 500 mm	Chrome	500 mm	400 mm	400 mm	500 mm	20.1 kg	136 kg	3 Years	AP17
MWS442911	Wheelchair Folding Std - Heavy Duty 22" 560 mm - 200kg	Chrome	550 mm	450 mm	400 mm	500 mm	27.2 kg	204 kg	3 Years	AP17
MWS442912	Wheelchair Folding Std - Heavy Duty 24" 610 mm - 200kg	Chrome	600 mm	450 mm	400 mm	500 mm	27.2 kg	204 kg	3 Years	AP17
MWS442901	Wheelchair Folding Std - Super HD 26" 650 mm	Chrome	650 mm	500 mm	450 mm	500 mm	36 kg	318 kg	3 Years	AP17
MWS442902	Wheelchair Folding Std Super HD 28" 700 mm	Chrome	700 mm	500 mm	450 mm	500 mm	36 kg	318 kg	3 Years	AP17
WCA858005	Elevating Legrests for HD									AP14
WCA858007	Stump Support Left for HD									AP14
WCA858008	Stump Support Right for HD									AP14
WCA858009	Stump Support Left for Super HD									AP14
WCA858010	Stump Support Right for Super HD									AP14
WCA858006	Elevating Legrests for Super HD									AP14



### Push Pull Wheelchair

- Single arm propelled wheelchair for home or hospital use
- Push pull lever designed for users with adequate upper limb strength in one arm
- Folding frame for easy storage and transportation
- Swing-away detachable footrests and removable armrests
- 24" quick-release pneumatic rear wheels plus 8" front castors
- Durable steel construction

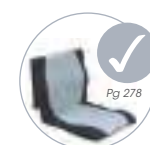

Code	Description	Colour	Seat Width	Seat Depth	Back Height	Product Weight	S.W.L	Warranty	DVA:
MWS442400	Push Pull Left 410 mm	Chrome	410 mm	410 mm	410 mm	14.2 kg	125 kg	2 Years Frame 1 Year Parts	AP19
MWS442500	Push Pull Right 410 mm	Chrome	410 mm	410 mm	410 mm	14.2 kg	125 kg	2 Years Frame 1 Year Parts	AP19
MWS442600	Push Pull Left 440 mm	Chrome	440 mm	410 mm	410 mm	14.2 kg	125 kg	2 Years Frame 1 Year Parts	AP19
MWS442700	Push Pull Right 440 mm	Chrome	440 mm	410 mm	410 mm	14.2 kg	125 kg	2 Years Frame 1 Year Parts	AP19
MWS442800	Push Pull Left 500 mm	Chrome	500 mm	410 mm	410 mm	14.2 kg	125 kg	2 Years Frame 1 Year Parts	AP19
MWS442900	Push Pull Right 500 mm	Chrome	500 mm	410 mm	410 mm	14.2 kg	125 kg	2 Years Frame 1 Year Parts	AP19

#### General Enquiries

P 1300 133 120 | E sales@aidacare.com.au | W www.aidacare.com.au



### Ottobock Start Wheelchair

**ottobock.**



#### Start - M2 & M2S

- Aluminium frame
- Tip-assist integrated into the frame
- Side panel as standard with height-adjustable, foldable, removable armrests
- Black Nylon seat and backrest upholstery
- Antibacterial push handles
- Adjustable steering head
- SWL: 130kg

#### Start XXL - M4

- Stable
- Up to 160 kg loads
- Seat width of up to 580mm
- Many variations
- Broad spectrum of adjustment options

#### Start Comfort - M2 Adjustable

- Adjustable back height and seat depth
- Aluminium frame
- Tip-assist integrated into the frame
- Side panel standard with height-adjustable, foldable, removable armrests
- Black Nylon seat and backrest upholstery
- Antibacterial push handles
- Adjustable steering head
- SWL: 130kg

Code	Description	DVA:
MWC449200	Start M2 - Lightweight	AP19
MWC449204	Start M2S - Adjustable - 380 mm	AP17
MWC449205	Start M2S - Adjustable - 430 mm	AP17
MWC449210	Start M2S - Adjustable - 455 mm	AP17
MWC449220	Start M2S - Adjustable - 400 mm	AP17
MWC449214	Start M2S - Standard - 405 mm	AP17
MWC449215	Start M2S - Standard - 455 mm	AP17
MWC449216	Start M2S - Standard - 505 mm	AP17

Code	Description	DVA:
MWC427440	Start XXL 505 mm	AP17
MWC427450	Start XXL 555 mm	AP17
MWC427460	Start XXL 580 mm	-

Code	Description	DVA:
MWC427360	Start Comfort QLD 380mm	-
MWC427370	Start Comfort 400mm	AP17
MWC427380	Start Comfort 430mm	-
MWC427390	Start Comfort 450mm	AP17
MWC427400	Start Comfort 480mm	-



#### Action 3 Junior

- Invacare Action 3 Junior is a lightweight, foldable paediatric wheelchair designed for children aged between 3 and 15 years

- Action 3 Junior has been developed to match the individual needs of the child and can grow as they grow



Code	Description	Seat Width	Seat Depth	Seat to Floor Height	Product Weight	S.W.L
MWS449190	Action 3 Junior	300 - 360 mm	200 - 360 mm	410 - 460 mm	7.2 kg	80 kg

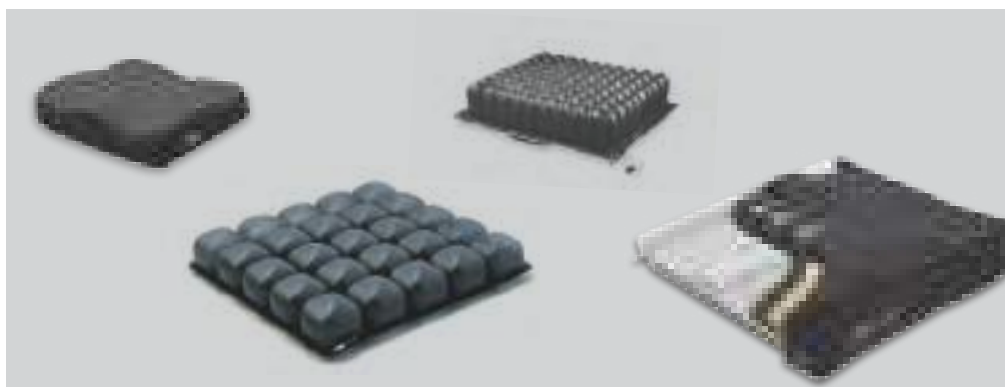

For Pressure Care Cushions Refer to Page 133

#### DVA Contact Details

P 1300 888 052 | F 1300 787 052 | E [dva@aidacare.com.au](mailto:dva@aidacare.com.au)



For NDIS Item Code, refer to page: 508

# Standard Power Wheelchairs



For NDIS Item Code, refer to page: 508



Brochures also available. Please contact us for a copy.



## Go Chair



- A lightweight power chair, designed for users with low seating and positioning needs
- Small turning radius - ideal for confined spaces
- Folding design pulls apart for easy transportation
- Max range per charge: 12.87km
- Swivel seat and flip back armrests assist with transfers

Code	Description	Overall Length	Overall Width	Maximum Speed	S.W.L	Warranty
PWS654200	Go Chair	825 mm	482 mm	5.65 km/h	113 kg	2 Years



## Go Chair Next Generation



- The first travel chair that combines super portability, maneuverability and style at a low cost
- One hand feather-touch disassembly into 4 manageable pieces which fits in most vehicle boots
- Compact design for a tight turning radius, ideal for indoor use
- Max range per charge: 14km
- 5-point swivel seat with latch release
- Increased 136 kg weight capacity
- Faster speed - up to 5.95 km/h
- Larger, 18 amp batteries
- 52 cm lap belt

Code	Description	Overall Length	Overall Width	Maximum Speed	S.W.L	Warranty
PWS654200RE	Go Chair - Red	838 mm	574 mm	5.95 km/h	136 kg	2 Years
PWS654200WH	Go Chair - White	838 mm	574 mm	5.95 km/h	136 kg	2 Years



## Jazzy Select 6



- The Jazzy Select 6 provides maximum front stability combined with the advantages of in-line motor technology
- Active-Trac Suspension and 6" front and rear castors offer superior performance indoors and outdoors
- The Jazzy Select 6 also features an articulating rear caster beam
- With an easy access charger point, The Jazzy Select 6 is built with ease of service in mind
- The Jazzy Select 6 comes standard with height and depth adjustable foot platform
- Takes two 12v 35amp batteries
- Max range per charge: 24km

Code	Description	Overall Length	Overall Width	Maximum Speed	S.W.L	Warranty
PWS654242	Jazzy Select 6	930 mm	600 mm	6.8 km/h	136 kg	2 Years

### General Enquiries

P 1300 133 120 | E sales@aidacare.com.au | W www.aidacare.com.au



### Jazzy Air

- Mid-Wheel 6® Drive Design with Active-Trac® Suspension for enhanced performance and maximum stability both indoors and out
- Elevates or lowers on the move with the touch of the "Air" button; stationary height adjustment via the PG VR 2 joystick drive controller
- 10" of power adjustable seat height in 16 seconds
- Angle, height and depth adjustable armrests
- Integrated seat and foot plate design with 3-position height and angle adjustment
- Bright LED marker lights
- Max range per charge: 30km

Code	Description	Overall Length	Overall Width	Maximum Speed	S.W.L	Warranty
PWS654267	Jazzy Air	1100 mm	595 mm	6.44 km/h	136 kg	2 Years



### Jazzy Select Elite 2

- The Jazzy Select Elite features in-line, front-wheel drive technology, which gives excellent stability and maneuverability.
- The Jazzy Select Elite comes standard with Comfort high-back seat with headrest
- Reliable blend of power, performance and style
- Excellent for indoor and outdoor performance
- Max range per charge: 21.97km

Code	Description	Seat Width	Overall Length	Overall Width	Maximum Speed	S.W.L	Warranty
PWS654255	Jazzy Select Elite - Red	584 mm	873 mm	584 mm	6.44 km/h	136 kg	2 Years



### Jazzy Select Elite HD

- The Jazzy Elite is an excellent heavy duty option, with a 204kg weight capacity.
- The Jazzy Select Elite HD features two-motor front wheel drive
- Comes standard with a Dynamic Shark controller
- Optimum weight distribution provides superior traction
- A highly maneuverable chair with a heavy duty construction to accommodate higher weight users
- Takes two 12v 55amp batteries
- Max range per charge: 16km

Code	Description	Overall Length	Overall Width	Maximum Speed	S.W.L	Warranty	DVA:
PWS654250	Jazzy Select Elite HD	920 mm	616 mm	6.5 km/h	204 kg	2 Years	AP16



### iGo Folding

- Quickly folds in 5 easy steps
- Unique seating for added comfort
- Front suspension
- Large, secure storage compartment
- Lightweight Lithium-ion batteries
- Easy-to-use VR2 controller
- Max range per charge: 20km

Code	Description	Seat Width	Overall Length	Overall Width	Maximum Speed	S.W.L	Warranty
PWS654175	iGo Folding - White	470 mm	875 mm	600 mm	5.95 km/h	120 kg	2 Years



		ADULT					Standing - Mid & Forward Wheel Drive		
		Mid Wheel Drive	Rear Wheel Drive	Mid & Rear Wheel Drive	Mid, Rear & Forward Wheel Drive	Mid, Rear, Forward & Hybrid Wheel Drive			
<b>POWER CHAIRS</b>	Seat Width ( mm )	Xperience 2	Xcel 2	Xplore 2	Q300	Q400	Q500	Q700	Q700UP
	Seat Depth ( mm )	250 - 610	500 - 710	250 - 610	Compatible with either: Sedeo Pro or Sedeo Lite	Compatible with either: Sedeo Pro or Sedeo Lite	Compatible with either: Sedeo Pro or Sedeo Lite	Compatible with either: Sedeo Pro or Sedeo Ergo	Compatible with Sedeo Ergo UP
	Floor to Seat Ht( mm )	250 - 560	430 - 610	250 - 560	415 - 490	415 - 490	415 - 490	415 - 490	415 - 490
	Max User Weight ( kg )	182	249	400	136	136	160	160	120
	Max Speed ( kph )	10	8.6	10	10	10	10	10	10
	Base W x L ( mm )	630 x 1100	700 x 1100	650 x 1100	NA	NA	NA	NA	NA
<b>Features</b>	Fully extendable controls. Anti shear recline and tilt. Low seat to floor height	HD version of the Xperience	Fully extendable controls. Anti shear recline and tilt. Low seat to floor height	Entry level chairs with ultra-compact mid or rear wheel drive bases for indoor agility and outdoor stability.	Robust outdoor chair, choice of three drive bases, for outdoor experience with advanced electronics.	Q400 features plus a choice of rehab seating systems provide support and positioning to users from mild to medium clinical needs	Outdoor/indoor use, choice of three drive bases, complex rehab seating systems to match users with specific or high clinical needs.	Advanced powerbase, comes with SpiderTrac™ 2.0 suspension, and SEDEO ERGO biomechanical seating system.	



		ADULT			
		SEDEO LITE	SEDEO PRO	SEDEO ERGO	SEDEO ERGO UP
<b>SEDEO SEATING</b>	Seat Width ( mm )	385 - 510	380 - 560	400 - 560	400 - 500
	Seat Depth ( mm )	410 - 560	400 - 560	400 - 560	400 - 540
	Height Lift Range ( mm )	300	300	300	200
	Compatible with	Q300, Q400, Q500	Q300, Q400, Q500, Q700	Q700	Q700UP
	Max User Weight ( kg )	136	160	160	160
<b>Features</b>	Mild - moderate clinical needs, multi-adjustable frame, Tilt and Lift Power Seating options, Integrated SEDEO, JAY and WHITMYER options	Moderate - complex clinical needs, Biomechanical Anti-shear backrest, Extensive seating options - SEDEO, JAY and WHITMYER	Complex clinical needs, Multi-adjustable frame, Biomechanical Anti-shear backrest, Programmable memory seat positions and Remote Seating	Complex clinical needs, multi-adjustable frame, Standing position, Biomechanical Anti-shear backrest, Memory seat positions & Remote Seating	

		PAEDIATRIC
		Mid Wheel Drive
<b>POWER CHAIRS</b>	Model	ZM-310
	Seat Width ( mm )	250 - v410
	Seat Depth ( mm )	250 - 480
	Floor to Seat Ht ( mm )	390 - 550
	Max User Weight ( kg )	75
	Max Speed ( kph )	10
Base W x L ( mm )	610 x 890	
<b>Features</b>	Power tilt, seat elevate, manual recline, fully expandable controls	





	ADULT										
	Rigid					Folding					Tilt In Space
	QRi	GPV, GPSA	Q7	5R	7R	QXi	Quickie 2 / Q2 Lite	Xenon / Xenon SA / Xenon Dual			
<b>MANUAL CHAIRS</b>											
Seat Width ( mm)	300 - 510	300 - 510	300 - 510	300 - 510	300 - 510	360 - 510	310 - 560, 350 - 500	320 - 500	360 - 510	360 - 510	
Seat Depth ( mm)	300 - 510	300 - 560	300 - 510	300 - 510	300 - 510	360 - 510	310 - 560, 350 - 500	340 - 500	360 - 510	360 - 560	
Floor to Seat Ht ( mm)	380 - 510	390 - 580	410 - 530	400 - 530	400 - 530	320 - 500	360 - 560	430 - 560	360 - 510	360 - 520	
Max User Weight (kg)	120	113	120	120	120	120	120 / 120	110 / 125 / 140	120	120	
Weight (kg)	10	11	6	5.8	4.5	13.25	8/13	4.9	17	17	
Features	Entry level rigid	Mid range rigid. Swing away leg option. Highly configurable	Top end rigid with extensive configuration	Highly adjustable including centre of gravity and backrest height and angle	Ultra lightweight, freestyle backrest system, highly adjustable	Entry level folding	Highly configurable scripted folding chair	Active user folding with rigid feel. Swing away legs option	Entry level folding	Entry level/TIS (rotational)	

### iXpress

All the convenience & transportability of a manual wheelchair. All the power & speed of a power chair.



	PAEDIATRIC						
	ADULT / PAED			Folding			Tilt In Space
	Tilt In Space	Rigid	Folding	Zippie "GS"	Zippie X'Cape	Zippie TS	
<b>MANUAL CHAIRS</b>							
Weight (kg)	10/17	6.5	11.5	8.6	14		
Seat Width ( mm)	113 / 135 / 158	200 - 460	250 - 460	203 - 406	250 - 460	250 - 460	
Seat Depth ( mm)	250 - 460, 360 - 560	200 - 480	250 - 510	203 - 406	330 - 560		
Floor to Seat Ht ( mm)	320 - 500	360 - 480	360 - 510	330 - 482	390 - 500		
Max User Weight (kg)	75 / 158	75	75	75	75		
Features	Highly configurable TIS (rotational)	Active user	Growth system. Front or rear wheel drive	Xlock Crossbrace for performance, Z-Finity system	Highly configurable TIS		







Mobility Wheelchairs  
& Positioning

**permobil**

POWER CHAIRS	ADULT			
	M1 Corpus	M3 Corpus	M300 Corpus HD	M5 Corpus
Seat Width ( mm )	355 - 560	430 - 580	480 - 635	430 - 580
Seat Depth ( mm )	355 - 560	360 - 560	480 - 635	360 - 560
Floor to Seat Ht ( mm )	405 - 455	445 - 495	460 - 510	445 - 495
Max User Weight (kg)	136	136	204	136
Based W x L ( mm )	610 x 950	610 x 900	660 x 965	635 x 950
Max Speed (kph)	8	10	8	10
Features	FlexLink™ suspension for advanced vibration reduction; CasterGlide™ technology promotes confidence in driving	Turning radius of 51 cm, PG 120 amp. R-Net electronics, Climbing and Traction Link system, Provides quick access to components	High torque motors; strengthened suspension; Corpus HD seating system; strong actuators; adjustable armrest and legrests	FlexLink™ suspension for advanced vibration reduction; ActiveReach™ allows 14" of seat elevation with up to 20° of forward tilt
				Compact base; adjustable suspension; R-net electronics; corpus 3G seating system; memory positioning fully adjustable armrests and legrests

POWER CHAIRS	ADULT				PAEDIATRIC			
	F5 Corpus	F3 Corpus	F5VS	Front Wheel Drive / Standing	Front Wheel Drive	Rear Wheel Drive	Mid Wheel Drive	Front Wheel Drive
Seat Width ( mm )	430 - 580	430 - 580	430 - 580	280 - 410	250 - 410	250 - 410	280 - 410	250 - 360
Seat Depth ( mm )	360 - 560	360 - 560	360 - 560	250 - 460	250 - 460	250 - 460	250 - 460	250 - 360
Floor to Seat Ht ( mm )	445 - 495	445 - 495	445 - 495	420	360 - 460	360 - 460	430	375
Max User Weight (kg)	136	136	136	75	60	60	75	35
Based W x L ( mm )	650 x 1070	610 x 1020	650 x 1090	610 x 1020	620 x 890	620 x 890	610 x 925	585 x 810
Max Speed (kph)	10	10	10	10	8	8	10	6.5
Features	Adjustable suspension, 14" seat elevate, articulated power footplate	Adjustable suspension, 12" seat elevate, power elevating legrests	Adjustable suspension, 14" seat elevate, automatic anti-tippers, articulated power footplate	Compact base; adjustable suspension; R-net electronics; fully growable seating system; height and angle adjustable, flip back armrests; removable legrests	Unique 'terra' function allows user access to the ground, Fully growable seating system, Advanced suspension system	Turning radius of 51cm, PG 120 amp. R-Net electronics, Climbing and Traction Link system, Provides quick access to components	True paediatric size power base and seating; fully growable seating systems; tilt and elevate standard	



MANUAL CHAIRS	ADULT						
	Standing			Folding			
	Helium LSA	Helium LS/LSE	2GX	Aero X	TR	Aero T	
Seat Width ( mm )	360 - 460	360 - 480	305 - 560	305 - 560	305 - 510	250 - 510	
Seat Depth ( mm )	430 - 540	410 - 550	305 - 510	305 - 510	305 - 510	250 - 510	
Floor to Seat Ht ( mm )	510	510	340 - 535	340 - 545	380 - 530	405 - 530	
Max User Weight (kg)	120	120	120	120	120	120	
Transport Weight (kg)	16	25 - 32	5.9	7.1	4.2	5.4	
Features	Lightweight, dual component knee pads, chest belt & armrests	LS offers manual standing, LSE offers a power function. Includes dual component knee pads, chest belt & armrests	Folding frame, high strength titanium, full adjustability & modular design. Aftermarket seating systems available.	Folding frame, full adjustability, heavy-duty, hemi and amputee options & modular design. Aftermarket seating systems available.	Lightweight, high strength titanium, custom made to size, sporting suspension, TiShaft back release bar.	Advanced aluminium chair, full adjustability, custom made to size, adjustable camber mount, Speedloader adjustable front caster housing.	Lightweight, high strength titanium, full adjustability, custom made to size, adjustable camber mount, Speedloader adjustable front caster housing.

MANUAL CHAIRS	ADULT					
	Rigid			PAEDIATRIC		
	ZR	Aero Z	TRA	Pilot	Twist	
Seat Width ( mm )	250 - 510	250 - 510	305 - 510	200 - 355	200 - 380	
Seat Depth ( mm )	250 - 510	250 - 510	305 - 510	230 - 380	200 - 410	
Floor to Seat Ht ( mm )	405 - 530	405 - 530	380 - 530	305 - 420	320 - 530	
Max User Weight (kg)	120	120	120 / 158 HD	43 (transit); 54 (standard)	75	
Transport Weight (kg)	4.2	5.6	5	4.9	5.3	
Features	Lightweight, easy car transportability, custom made to size, swept caster arm & TiShaft back release bar.	Lightweight, high strength titanium, full adjustability, modular design, adjustable camber mount, Speedloader adjustable front caster housing.	Lightweight, full adjustability, modular design, adjustable camber mount, Speedloader adjustable front caster housing.	Ultra-lightweight carbon-fibre, ready to grow adjustability, easy to reach wheel locks	Ready to grow width and depth adjustability, optional parent friendly push handle	

Related Products:



Mobility Wheelchairs & Positioning





Mobility Wheelchairs  
& Positioning

**PRIDE**  
MOBILITY  
LIVE YOUR BEST!



POWER CHAIRS	ADULT									
	Mid Wheel Drive					Q6 Edge Z				
	O6 Edge HD	O6 Edge 2.0 with iLevel	Q1450 (Bariatric)	J63 Package	Synergy	TRU-Balance 3 Static Seat	TRU-Balance 3 Power Tilt	TRU-Balance 3 Lift		
Seat Width ( mm )	510 - 710	300 - 560	510 - 810	457	250 - 610	305 - 610	305 - 610	305 - 610	305 - 610	305 - 610
Seat Depth ( mm )	510 - 710	300 - 560	510 - 710	457	250 - 610	305 - 610	355 - 610	305 - 610	305 - 610	305 - 610
Floor to Seat Ht ( mm )	420 - 470	400 - 450	420 - 470	-	445 - 495	445 - 495	460 - 510	490 - 540	490 - 540	490 - 540
Max User Weight ( kg )	204	136	272	136	136	136	136	136	136	136
Base W x L ( mm )	660 x 904	622 x 902	743 x 970	610 x 901	667 x 904	667 x 904	667 x 904	667 x 904	667 x 904	667 x 904
Max Speed (kph)	7.6	9.66	7.24	8	9.9	9.9	9.9	9.9	9.9	9.9
Features	HD version of O6 Edge. 66cm base	Fully expandable controls. Full power functions. Tilt, recline and power ALR. iLevel 10" seat elevation. Advanced suspension	Basic LED or fully expandable controls. Tilt & recline seating available. 272kg & 74cm width	Height-Adjustable armrests, TRU Balance 50° tilt, Swing away legrests, adjustable foot plates or centre-mount footboard	Low impact OMNI-Casters prevent wheel hang-ups, ATX Suspension, iLevel option, patented Extra Stability Technology	Low impact OMNI-Casters prevent wheel hang-ups, ATX Suspension, iLevel option, patented Extra Stability Technology	Low impact OMNI-Casters prevent wheel hang-ups, ATX Suspension, iLevel option, patented Extra Stability Technology	Low impact OMNI-Casters prevent wheel hang-ups, ATX Suspension, iLevel option, patented Extra Stability Technology	Low impact OMNI-Casters prevent wheel hang-ups, ATX Suspension, iLevel option, patented Extra Stability Technology	Low impact OMNI-Casters prevent wheel hang-ups, ATX Suspension, iLevel option, patented Extra Stability Technology

POWER CHAIRS	ADULT									
	Q6 Edge 3 Base					Quantum 4Front				
	Synergy or TRU-Balance 3 Static Seat	TRU-Balance 3 Power/Tilt	TRU-Balance 3 Power/Tilt & iLevel	TRU-Balance 3 Static Seat	TRU-Balance 3 Power Tilt	TRU-Balance 3 Lift & Tilt	Rear Wheel Drive			
Seat Width ( mm )	254 - 559	305 - 559	305 - 559	305 - 560	305 - 560	305 - 560	250 - 560	250 - 560	250 - 560	250 - 560
Seat Depth ( mm )	254 - 559	305 - 559	305 - 559	305 - 560	305 - 560	305 - 560	250 - 560	250 - 560	250 - 560	250 - 560
Floor to Seat Ht ( mm )	419 - 470	445 - 495	445 - 449	387 - 438	445 - 459	450 - 500	450	450	450	450
Max User Weight ( kg )	136	136	136	136	136	136	136	136	136	136
Base W x L ( mm )	662 x 820	662 x 820	662 x 820	616 x 1014	616 x 1014	616 x 1014	640 x 880	640 x 880	640 x 880	640 x 880
Max Speed (kph)	9.6	9.6	7.24	9.6	9.6	9.6	9.65	9.65	9.65	9.65
Features	Upgraded Smooth Ride Suspension, Fender lights and USB charger, Bold new colours	Upgraded Smooth Ride Suspension, Fender lights and USB charger, Bold new colours	Upgraded Smooth Ride Suspension, Fender lights and USB charger, Bold new colours	Castor Angle Sensor Encoder tech. Smooth Ride Suspension, Q-Logic 3 EX Advanced Controls	Castor Angle Sensor Encoder tech. Smooth Ride Suspension, Q-Logic 3 EX Advanced Controls	Castor Angle Sensor Encoder tech. Smooth Ride Suspension, Q-Logic 3 EX Advanced Controls	Castor Angle Sensor Encoder tech. Smooth Ride Suspension, Q-Logic 3 EX Advanced Controls	Castor Angle Sensor Encoder tech. Smooth Ride Suspension, Q-Logic 3 EX Advanced Controls	Castor Angle Sensor Encoder tech. Smooth Ride Suspension, Q-Logic 3 EX Advanced Controls	Fully expandable controls. Tilt, recline and elevating leg available



# ottobock.

POWER CHAIRS	ADULT						PAEDIATRIC
	Rear Wheel Drive		Mid / Rear / Front Wheel Drive		Rear / Front Wheel Drive	Rear Wheel Drive - Sit to Stand	Rear Wheel Drive
	A200	B4	B5	B6	C2000	Paragolfer	Skippi
Seat Width ( mm )	340 - 480	340 - 560	340 - 560	340 - 560	380 - 560	460	300 - 380
Seat Depth ( mm )	340 - 500	340 - 580	340 - 500	340 - 500	380 - 560	356 - 510	280 - 380
Floor to Seat Ht ( mm )	430 - 480	410 - 540	400 - 550	400 - 550	470 - 530	510 - 660	430
Max User Weight (kg)	100	160	140 / 160	140 / 160	160 - 200	140	50
Base W x L ( mm )	570 x 1000	590 x 850	Size 1 - 600 x 900 Size 2 - 640 x 970	Size 1 - 600 x 900 Size 2 - 640 x 970	680 x 1390	900 x 1490	570 x 850
Max Speed (kph)	6	6 / 7.2 / 10	6 / 7.2 / 10 / 14	6 / 7.2 / 10 / 14	10	10	6
Features	LED single function control. Manual back recline. 20km range. Detachable control panel	High level of flexibility, 34 - 45km range, compact for indoors, drive wheel suspension for uneven surfaces	High level of flexibility, VAS frame solution, ergo-joint back support angle adjust, 35km range	High level of flexibility, VAS frame solution, ergo-joint back support angle adjust, 35km range	Rugged terrain. Power drive castors. Seat raise 40cm. Centre mount legrests. 60km range	Powerful sit-to-stand used in sports. Wide base for stability	Expandable controls. Detachable seat for travel. Attendant control & lighting

MANUAL CHAIRS	ADULT			ADULT / PAED	PAEDIATRIC
	Folding		Rigid	Rigid	Folding
	Start Range (M2, M2S, XXL)	Avantgarde (DS & DV)	Zenit	Zenit R	Start JNR
Seat Width ( mm )	380 - 505	320 - 520	320 - 460	320 - 460	280 - 380
Seat Depth ( mm )	430 - 455	360 - 540	360 - 500	360 - 500	240 - 400
Floor to Seat Ht ( mm )	360 - 510	360 - 540	280 - 510	280 - 510	395 - 520
Max User Weight (kg)	130	100, 140	120	120	90
Transport Weight (kg)	8.7	8.7 - 9	7.75	7.75	13.5

Mobility Wheelchairs & Positioning



	ADULT					
	Mid Wheel Drive			Rear Wheel Drive		
	Rovi X3	TDX SP	TDX SR	3G Torque	3G ARROW	
<b>Seat Width ( mm )</b>	280 - 550	300 - 600	300 - 600	300 - 550	300 - 610	
<b>Seat Depth ( mm )</b>	250 - 580	300 - 550	300 - 550	300 - 550	300 - 560	
<b>Floor to Seat Ht ( mm )</b>	410 - 430	400 - 450	420 - 520	420 - 530	440 - 530	
<b>Max User Weight (kg)</b>	136	136 (Std), 180 (HD)	136 (Std), 180 (HD)	136 - 180	159 (Std), 181 (HD)	
<b>Base W x L ( mm )</b>	600 x 1150	610 x 900	650 x 900	630 x 800	630 x 800	
<b>Max Speed (kph)</b>	8	9	11.2	9	10	
<b>Features</b>	Patented ARC (Active Ride Control) suspension. Full power seat functions available	Stability Assist, Sure Step, G-Trac	Stability Assist, Sure Step, True-Trac	Rear-wheel suspension. Full power seat functions available	Rear wheel suspension, gearless & brushless motors. Full power seat functions available	



	ADULT										PAEDIATRIC			
	Folding					Rigid					Tilt in Space		Folding	
	Kuschall Compact	Kuschall Ultralight	Kuschall Champion	Kuschall Advance	Top End Crossfire T6	Kuschall KSL	Crossfire T7A	Solara 3G	Action 3 Junior	Freedom NXT				
<b>Seat Width ( mm )</b>	280 - 500	280 - 500	340 - 460	340 - 460	300 - 460	340 - 420	300 - 500	305 - 610	300 - 360	255 - 510				
<b>Seat Depth ( mm )</b>	320 - 500	320 - 500	340 - 460	360 - 520	360 - 460	375 - 475	360 - 500	305 - 560	200 - 360	305 - 510				
<b>Floor to Seat Ht ( mm )</b>	380 - 530	430 - 530	430 - 540	450 - 550	410 - 530	450 - 510	400 - 530	320 - 480	410 - 460	320 - 495				
<b>Max User Weight (kg)</b>	130	130	120	125	113	100	113	113 - 118	80	91				
<b>Transport Weight (kg)</b>	11	9.9	10.7	7.5	8.8	6.7	8	15	7.2	10				

**MANUAL CHAIRS**



# Wheelchair Backrests

I ♥ ndis For NDIS Item Code, refer to page: 508

## Sunrise Medical - JAY Backrests Overview

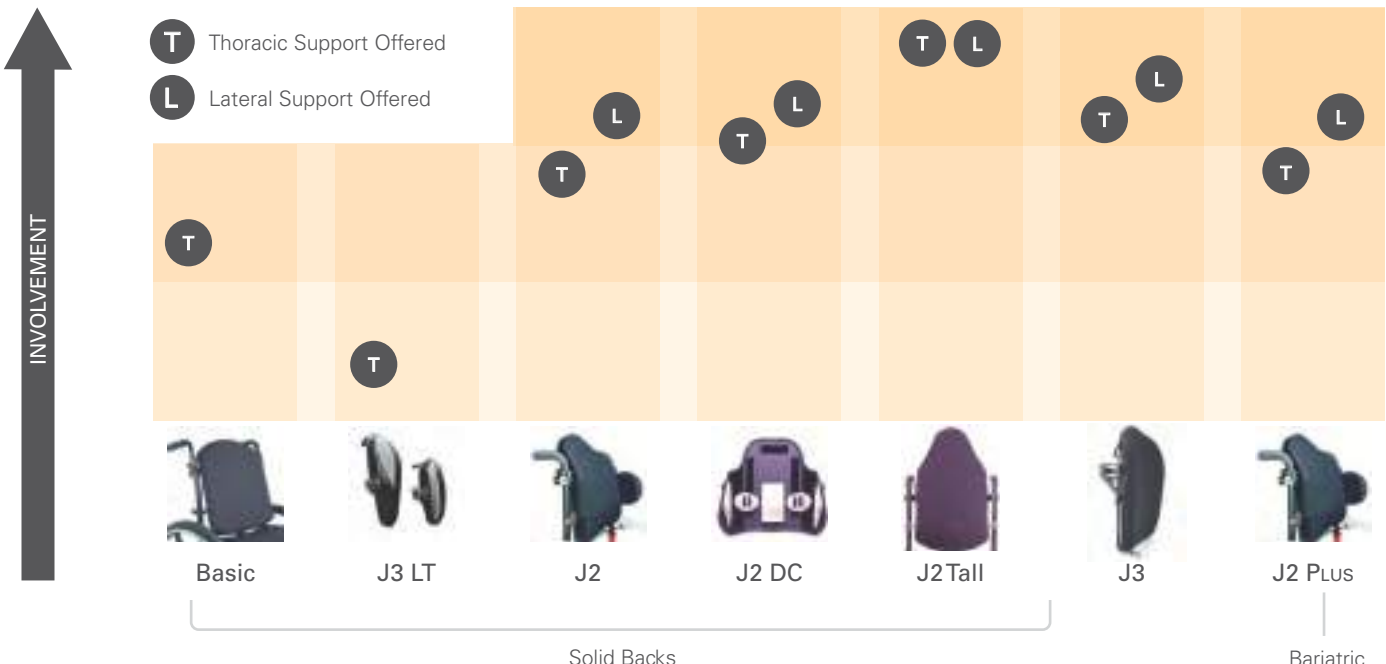

OFF-THE-SHELF      LEVEL OF CONSULTATION      COMPLEX REHAB SCRIPTED

SPECIFIC APPLICATIONS:  
 JAY CARE - 39° of angle adjustment to accommodate a kyphotic posture; J2 PLUS - 295 kg weight capacity



For Pressure Care Cushions Refer to Page 133

### DVA Contact Details

P 1300 888 052 | F 1300 787 052 | E [dva@aidacare.com.au](mailto:dva@aidacare.com.au)



Jay J2 with lateral supports



Jay J2 Tall Back

Note: The J2 & J2 Tall are available in a wide range of sizes. Common sizes only are shown in the table. For sizes outside of the codes displayed, please contact your Aidacare Complex Rehab. Consultant.

\*Chair width dimensions are taken inside back canes.

### JAY - J2 & J2 Tall Backrest

- Designed for the client who has minimal to moderate postural needs that may change over time
- The lightweight contoured aluminium shell and contoured foam insert along with 15° of tilt and height adjustability replace the standard wheelchair back upholstery
- J2 provides excellent posterior pelvis stabilisation and posterior thoracic support
- The J2 also has multiple compatible options such as swing-away lateral supports, offset hardware kits and fluid pads to reduce spinal pressure points
- Contoured foam insert distributes pressure over wider area to increase comfort and reduce the risk of skin breakdown

### J2 Tall

- The J2 Tall is designed for the taller client with a need for longer trunk support the without interfering with upper limb functional activities
- Provides more aggressive lateral support than the standard J2

#### All models include

- Lumbar Shims
- Jay AirExchange cover
- Universal mounting hardware



**JAY**

Code	Chair Width*	Backrest Width	Backrest Height	S.W.L	Warranty	DVA:
PTB532260	11 - 13"	12"	12.5"	113 kg	2 Years (6mths on cover)	-
PTB532265	12 - 14"	13"	13"	113 kg	2 Years (6mths on cover)	-
PTB532270	13 - 15"	14"	14.5"	113 kg	2 Years (6mths on cover)	-
PTB532280		14"	21"	113 kg		-
PTB532300	14 - 16"	15"	21"	113 kg	2 Years (6mths on cover)	AP14
PTB532310	15 - 17"	16"	16.5"	113 kg	2 Years (6mths on cover)	AP14
PTB532320		16"	22"	113 kg		AP14
PTB532330	16 - 18"	17"	16.5"	113 kg	2 Years (6mths on cover)	AP14
PTB532340		17"	22"	113 kg		AP14
PTB532350	17 - 19"	18"	16.5"	113 kg	2 Years (6mths on cover)	AP14
PTB532360		18"	22"	113 kg		AP14
PTB532370	18 - 20"	19"	16.5"	113 kg	2 Years (6mths on cover)	AP14
PTB532380		19"	23"	113 kg		AP14
PTB532390	19 - 21"	20"	17.5"	113 kg	2 Years (6mths on cover)	AP14
PTB532400		20"	23"	113 kg		AP14

### JAY - J2 Plus Backrest

- Designed specifically to address the pelvic and trunk stability needs of bariatric clients
- To accommodate weight changes, the Jay® J2 Plus Back incorporates adjustable sliding hardware. This, along with a moveable growth plate that is used to contain excess tissue, provides up to 3 inches in width adjustment

- A combination of slots in the shell and a special spacer-fabric lining in the cover promote the movement of air in and around the foam base to reduce heat and moisture

#### All models include

- Jay AirExchange cover
- Universal mounting hardware

**JAY**



Jay J2 Plus Backrest

Code	Description	S.W.L	Warranty	DVA:
PTB532160	JAY - J2 Plus Backrest, 20-23in, 0°	294 kgs	2 Years (6mths on cover)	AP14
PTB532170	JAY - J2 Plus Backrest, 20-23in with Headrest	294 kgs	2 Years (6mths on cover)	AP14



Jay BASIC - pictured mounted

Note: Common sizes only are shown in the table. For sizes outside of the codes displayed, please contact your Aidacare Complex Rehab. Consultant.

Note: Each width size is available in a short (16", med (18") or Long (20").

\*Chair width dimensions are taken inside back canes.

### JAY - BASIC Backrest

- Designed for the client with mild postural needs the JAY BASIC backrest replaces existing wheelchair upholstery and provides rigidity to the chair
- An off-the-shelf product, the JAY BASIC backrest is easily attached to wheelchair uprights with the mounting hardware included with the backrest
- The backrest can be reclined up to 8° and has three height positions to better tailor the solution to the user
- The backrest has a lightweight aluminium shell with a soft foam insert and breathable AirExchange cover

#### All models include

- Jay AirExchange cover
- Mounting hardware - Strap or Clamp

**JAY**

Code	Chair Width*	Backrest Width	Backrest Height	S.W.L	Warranty	DVA:
PTB532503	13 - 15"	14"	18"	113 kg	2 Years (6mths on cover)	-
PTB532504	15 - 17"	16"	20"	113 kg	2 Years (6mths on cover)	-
PTB532510	17 - 19"	18"	18"	113 kg	2 Years (6mths on cover)	AP14
PTB532505	19 - 21"	20"	18"	113 kg	2 Years (6mths on cover)	AP14



Note: Common sizes only are shown in the table. For sizes outside of the codes displayed, please contact your Aidacare Complex Rehab. consultant.

\*Chair width dimensions are taken inside back canes.

### Jay - ZIP Backrest

- Designed specifically to provide posterior and mild lateral thoracic support for active kids aged 2 to 15 years of age
- The contour shapes vary by size, designed to accommodate the unique shapes of clients of each width. The Zip's extra soft foam provides superior immersion for children's lower weights
- Versatile hardware offers 3" of depth adjustment and 1" of width adjustment to accommodate kids' rapid growth. Its 40° of angle adjustability helps to improve visual orientation and function
- The Zip features an innovative, dual-cover system. The inner cover is water-resistant and easy to wipe off and clean, while its Aqua-guard zipper and anti-wicking thread protect the foam from fluids. The machine-washable, stretch outer cover utilises naturally antimicrobial, silver-impregnated X-static® fiber

#### All models include

- X-static® silver thread stretch cover
- Universal mounting hardware

**JAY**

Code	Chair Width*	Backrest Width	Backrest Height	S.W.L	Warranty
PTB533844	9 - 11"	10"	10"	75 kg	2 Years (6mths on cover)
PTC585194	11 - 13"	12"	8"	75 kg	2 Years (6mths on cover)
PTB533847	11 - 13"	12"	10"	75 kg	2 Years (6mths on cover)
PTB533845	11 - 13"	12"	12"	75 kg	2 Years (6mths on cover)
PTB533848	13 - 15"	14"	12"	75 kg	2 Years (6mths on cover)





- 1** Adjustable posterior/lateral pelvic shims help stabilise the pelvis.
- 2** Adjustable posterior pelvic support contours the foam and positions the pelvis.
- 3** Adjustable lateral support shims gently hug the body for increased trunk stability.

Note: The J2 DC is available in a wide range of sizes. Common sizes only are shown in the table. For sizes outside of the codes displayed, please contact your Aidacare Complex Rehab. Consultant.

\*Chair width dimensions are taken inside back canes.

### JAY - J2 Deep Contour Backrest

- Designed for the client who has moderate postural needs who needs a lightweight, easy-to-use back support that provides both pelvic and trunk positioning
- Multiple positioning accessories; height adjustability and tilt of up to 15° allow the J2 DC backrest to alter in accordance with the client's changing needs over time
- Deep lateral walls provide excellent lateral trunk stability whilst the shape and size of the backrest minimises upper limb interference and don't compromise seat depth

#### All models include

- Jay AirExchange cover
- Universal mounting hardware
- 2 lateral support wedges
- 2 posterior pelvic supports



**JAY**

Code	Chair Width*	Backrest Width	Backrest Height	S.W.L	Warranty	DVA:
PTB532180	13 - 15"	14"	18"	113 kg	2 Years (6mths on cover)	AP14
PTB532190	14 - 16"	15"	19"	113 kg	2 Years (6mths on cover)	AP14
PTB532200	15 - 17"	16"	19"	113 kg	2 Years (6mths on cover)	AP14
PTB532210	16 - 18"	17"	19"	113 kg	2 Years (6mths on cover)	AP14
PTB532220	17 - 19"	18"	19"	113 kg	2 Years (6mths on cover)	AP14
PTB532230	18 - 20"	19"	19"	113 kg	2 Years (6mths on cover)	AP14
PTB532240	19 - 21"	20"	19"	113 kg	2 Years (6mths on cover)	AP14



Note: Each size group is available as a Regular or Tall

Note: The JAY Focus Point is available in a wide range of sizes. Common sizes only are shown in the table. For sizes outside of the codes displayed, please contact your Aidacare Complex Rehab. Consultant.

\*Chair width dimensions are taken inside back canes.

### JAY - Focus Point Backrest

- Designed for the client who has moderate to high postural needs who needs an easy-to-use back support that provides both posterior pelvic and lateral positioning that will change over time
- The Jay Focus Point is a 3 piece backrest featuring a reinforced contoured aluminium shell, multi-adjustable lateral wings and a pelvic wedge for additional posterior pelvic support
- Featuring back height adjustment of 4"; forward tilt (20°); rear tilt (45°); and multiple optional positioning supports, the JAY Focus Point provides the flexibility to adapt to the changing needs of the client
- The shape of the JAY Focus Point minimises upper limb interference

#### All models include

- Universal mounting hardware
- 3 piece cover



**JAY**

Code	Chair Width*	Backrest Width*	Backrest Height	S.W.L	Warranty	DVA:
PTB532685	14 - 15"	14 - 15"	14"	113 kg	2 Years (6mths on cover)	-
PTB532686	14 - 15"	14 - 15"	17"	113 kg	2 Years (6mths on cover)	-
PTB532690	16 - 17"	16 - 17"	15"	113 kg	2 Years (6mths on cover)	AP14
PTB532700	16 - 17"	16 - 17"	18"	113 kg	2 Years (6mths on cover)	AP14
PTB532710	18 - 19"	18 - 19"	16"	113 kg	2 Years (6mths on cover)	AP14
PTB532720	18 - 19"	18 - 19"	19"	113 kg	2 Years (6mths on cover)	AP14
PTB532724	20 - 21"	20 - 21"	17"	113 kg	2 Years (6mths on cover)	-
PTB532725	20 - 21"	20 - 21"	20"	113 kg	2 Years (6mths on cover)	AP14



### JAY - J3 Backrest

The Jay-J3 series of backrests are highly customisable to suit your client's needs.

Customisations cover 5 spectrums: (1) Contour Depth; (2) Level of Support; (3) Back Support Height; (4) Backrest Width; (5) Mounting Hardware.

Various options within each spectrum create an enormously flexible package.

We strongly recommend that you consult with your Aidacare Complex Rehab team member for any inquiries relating to these cushions.



**JAY**



- The J3 Back is dedicated to eliminating compromises when different products are bundled. J3 ensures compatibility between solutions by encompassing a huge array of options within the one range
- The J3 Back features one of the widest ranges of available accessories including multiple lateral sizes, Spine-Align positioning components, Whitmyer® headrests, Comfort Fit® chest straps and trunk straps
- Every J3 back features special new spacer fabric upholstery designed to wick moisture away from the skin and circulate air flow throughout the cover
- 135 kg capacity on standard models and 225 kg in models over 22"
- The J3 back provides up to 22° of back angle adjustment with minimal to zero loss of seat depth. This is especially helpful for individuals with postural deformities who may require more extreme angles
- Fitting the back to the user not the user to the back is the goal of the Spine-Align Posture Conforming system. This is accomplished by combining a wide range of individual foam components to create unique shapes that optimise postural support, evenly distribute pressure and maximise function. Velcro strips attach to each shape so they can be placed into hundreds of configurations. The flexibility of the system is endless



J3 Contour Depth Profile



J3 Range of Trunk Support



### Ottobock Baxx Backrests

**ottobock.**

- The Ottobock Baxx Line is divided into the Baxx Aluminum Back Series (AL) and the Baxx Aluminium Flat Top Back Series (AFT)
- Both series are anatomically shaped with a rigid aluminum shell
- Large cut-outs in the shell reduce weight and simplify handling
- The backs are padded at the top for comfortable sitting during everyday activities.
- The Baxx Line backs are available in 5 lengths, 3 contour depths and eleven widths to enable selection tailored to the individual's needs
- In addition Ottobock Baxx are available in various colours to match the Ottobock wheelchair frames, if desired.
- The Ottobock Baxx Line have three sizing dimensions. The back width, the back length and the contour depth
- The Baxx AL series (lengths 250 / 330 / 410 mm) has a scapular cut out allow free movement of the shoulder blades making them ideal for active users
- The Baxx AFT series (lengths 460 / 510 mm) include scapular support for maximum stability making them suitable for users with more complex needs



The Ottobock Baxx range of backrests are highly customisable to suit your client's needs.

We strongly recommend that you consult with your Aidacare Complex Rehab team member for any inquiries

#### DVA Contact Details

P 1300 888 052 | F 1300 787 052 | E [dva@aidacare.com.au](mailto:dva@aidacare.com.au)



## Dreamline Pro Backrest



- Dreamline PRO backrests are constructed from ultra-lightweight carbon fibre with low to mid back height options for the active user
- Includes lumbar pad and lateral stability wedges
- High resilient foam inner for durability

Fixed Code	Quick Release Code	Chair Width	Backrest Width	Backrest Height	SWL	Warranty
PTB538100	PTB538400	12"	11"	6"	135 kg	2 Year
PTB538110	PTB538410			8"	135 kg	2 Year
PTB538120	PTB538420			10"	135 kg	2 Year
PTB538130	PTB538430	14"	13"	7"	135 kg	2 Year
PTB538150	PTB538450			11"	135 kg	2 Year
PTB538160	PTB538460			13"	135 kg	2 Year
PTB538140	PTB538440			19"	135 kg	2 Year
PTB538170	PTB538470	16"	15"	7"	135 kg	2 Year
PTB538180	PTB538480			9"	135 kg	2 Year
PTB538190	PTB538490			11"	135 kg	2 Year
PTB538200	PTB538500			13"	135 kg	2 Year
PTB538210	PTB538510			15"	135 kg	2 Year
PTB538220	PTB538520	18"	17"	7"	135 kg	2 Year
PTB538230	PTB538530			9"	135 kg	2 Year
PTB538240	PTB538540			11"	135 kg	2 Year
PTB538250	PTB538550			13"	135 kg	2 Year
PTB538260	PTB538560	20"	19"	15"	135 kg	2 Year
PTB538270	PTB538570			7"	135 kg	2 Year
PTB538280	PTB538580			9"	135 kg	2 Year
PTB538290	PTB538590			11"	135 kg	2 Year
PTB538300	PTB538600			13"	135 kg	2 Year
PTB538310	PTB538610			15"	135 kg	2 Year

Custom sizes also available on request



## Dreamline Contour Backrest



- The Dreamline CONTOUR backrest's signature BUBBLE contour improves immersion, enabling the backrest to closely match the contours of the body
- A central channel relieves pressure along the spinal column
- Carefully constructed with foam by bonding high resilience foam to a high density, impact absorbing, visco-elastic overlay to provide maximum support
- Strategically positioned ventilation holes in the foam and backrest shell, provide excellent air exchange
- Additional Polymer Gel inserts are available on request as a modification

Fixed Code	Quick Release Code	Chair Width	Backrest Width	Backrest Height	SWL	Warranty
PTB538700	PTB538900	8"	7"	10"	135 kg	2 Year
PTB538710	PTB538910			12"	135 kg	2 Year
PTB538720	PTB538920	10"	9"	12"	135 kg	2 Year
PTB538730	PTB538930			14"	135 kg	2 Year
PTB538740	PTB538940	12"	11"	14"	135 kg	2 Year
PTB538750	PTB538950			16"	135 kg	2 Year
PTB538760	PTB538960			18"	135 kg	2 Year
PTB538770	PTB538970	14"	13"	16"	135 kg	2 Year
PTB538780	PTB538980			18"	135 kg	2 Year
PTB538790	PTB538990			20"	135 kg	2 Year
PTB538800	PTB539000	16"	15"	18"	135 kg	2 Year
PTB538810	PTB539010			20"	135 kg	2 Year
PTB538820	PTB539020			22"	135 kg	2 Year
PTB538830	PTB539030	18"	17"	18"	135 kg	2 Year
PTB538840	PTB539040			20"	135 kg	2 Year
PTB538850	PTB539050			22"	135 kg	2 Year
PTB538860	PTB539060	20"	19"	18"	135 kg	2 Year
PTB538870	PTB539070			20"	135 kg	2 Year
PTB538880	PTB539080			22"	135 kg	

Custom sizes also available on request



### Dreamline Support Backrest



- The Dreamline SUPPORT backrest is designed as a platform for attaching supports such as swingaway laterals and harnesses for the high needs user
- Can be upgraded to include the BAC System
- Aluminium shell with multiple holes for attachment points improve air-exchange
- The backrest inner has channels and holes for improved air-exchange and conformability
- A medium density slim foam core for excellent upper trunk support is overlaid with Sunmate viscoelastic foam for long term comfort and enhanced immersion

Fixed Code	Quick Release Code	Chair Width	Backrest Width	Backrest Height	SWL	Warranty
PTB539100	PTB539400	8"	7"	10"	135 kg	2 Year
PTB539110	PTB539410			12"	135 kg	2 Year
PTB539120	PTB539420	10"	9"	12"	135 kg	2 Year
PTB539130	PTB539430			14"	135 kg	2 Year
PTB539140	PTB539440	12"	11"	14"	135 kg	2 Year
PTB539150	PTB539450			16"	135 kg	2 Year
PTB539160	PTB539460			18"	135 kg	2 Year
PTB539170	PTB539470	14"	13"	14"	135 kg	2 Year
PTB539180	PTB539480			16"	135 kg	2 Year
PTB539190	PTB539490			18"	135 kg	2 Year
PTB539200	PTB539500			20"	135 kg	2 Year
PTB539210	PTB539510	16"	15"	16"	135 kg	2 Year
PTB539220	PTB539520			18"	135 kg	2 Year
PTB539230	PTB539530			20"	135 kg	2 Year
PTB539240	PTB539540			22"	135 kg	2 Year
PTB539250	PTB539550	18"	17"	18"	135 kg	2 Year
PTB539260	PTB539560			20"	135 kg	2 Year
PTB539270	PTB539570			22"	135 kg	2 Year
PTB539280	PTB539580	20"	19"	18"	135 kg	2 Year
PTB539290	PTB539590			20"	135 kg	2 Year
PTB539300	PTB539600			22"	135 kg	2 Year

Custom sizes also available on request



Custom sizes also available on request



### Dreamline S3 Backrest

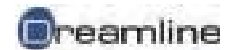

- The S3 backrest is a thick comfortable option due to its "cube cut" soft foam that gently moulds to the end user
- The S3 backrest is designed for individuals with minimal positioning needs
- The addition of the BAC System allows the S3 to address postural asymmetries while still providing the highest level of comfort

Code	Chair Width	Backrest Width	Backrest Height	SWL	Warranty
PTB539700	8"	7"	10"	135 kg	2 Year
PTB539710			12"	135 kg	2 Year
PTB539720	10"	9"	12"	135 kg	2 Year
PTB539730			14"	135 kg	2 Year
PTB539740	12"	11"	14"	135 kg	2 Year
PTB539750			16"	135 kg	2 Year
PTB539760			18"	135 kg	2 Year
PTB539770	14"	13"	14"	135 kg	2 Year
PTB539780			16"	135 kg	2 Year
PTB539790			18"	135 kg	2 Year
PTB539800			20"	135 kg	2 Year
PTB539810	16"	15"	16"	135 kg	2 Year
PTB539820			18"	135 kg	2 Year
PTB539830			20"	135 kg	2 Year
PTB539840			22"	135 kg	2 Year
PTB539850	18"	17"	18"	135 kg	2 Year
PTB539860			20"	135 kg	2 Year
PTB539870			22"	135 kg	2 Year
PTB539880	20"	19"	18"	135 kg	2 Year
PTB539890			20"	135 kg	2 Year
PTB539900			22"	135 kg	2 Year



Custom sizes also available on request



### Dreamline BAC System

- The BAC (Backrest Advanced Contour) System can be retro fitted to any Dreamline SUPPORT or S3 backrest as an upgrade enabling accurate asymmetrical contouring for high needs users
- Consists of multiple pads which can be layered in any position or orientation on the backrest to match the user
- 4-way stretch cover provides limitless build possibilities
- Positioning pads are small for better accuracy, may be rotated to any angle and positioned anywhere on the rigid inner shell
- 10 extra BAC positioning pads are supplied with each backrest

Code	Chair Width	Backrest Width	Backrest Height	SWL	Warranty
PTB540100	8"	7"	10"	135 kg	2 Year
PTB540110			12"	135 kg	2 Year
PTB540120	10"	9"	12"	135 kg	2 Year
PTB540130			14"	135 kg	2 Year
PTB540140	12"	11"	14"	135 kg	2 Year
PTB540150			16"	135 kg	2 Year
PTB540160			18"	135 kg	2 Year
PTB540170	14"	13"	14"	135 kg	2 Year
PTB540180			16"	135 kg	2 Year
PTB540190			18"	135 kg	2 Year
PTB540200			20"	135 kg	2 Year
PTB540210	16"	15"	16"	135 kg	2 Year
PTB540220			18"	135 kg	2 Year
PTB540230			20"	135 kg	2 Year
PTB540240			22"	135 kg	2 Year
PTB540250	18'	17'	18"	135 kg	2 Year
PTB540260			20"	135 kg	2 Year
PTB540270			22"	135 kg	2 Year
PTB540280	20"	19"	18"	135 kg	2 Year
PTB540290			20"	135 kg	2 Year
PTB540300			22"	135 kg	2 Year



Custom sizes also available on request



### Dreamline STX

- Multiple pillows of viscoelastic foam which may be layered in any orientation to match the user
- Outer breathable cover, inner cover contains positoning pillows to create a zone for therapists
- Multiple Sunmate cluster packs attach to the inner pad, while visco-elastic foam inside pillows mould to the end-user's body shape
- Comfort and positioning of asymmetrical postures

Code	Chair Width	Backrest Width	Backrest Height	SWL	Warranty
PTB540400	8"	7"	10"	135kg	2 Year
PTB540410			12"	135kg	2 Year
PTB540420	10"	9"	12"	135kg	2 Year
PTB540430			14"	135kg	2 Year
PTB540440	12"	11"	12"	135kg	2 Year
PTB540450			14"	135kg	2 Year
PTB540460			16"	135kg	2 Year
PTB540470	14"	13"	18"	135kg	2 Year
PTB540480			14"	135kg	2 Year
PTB540490			16"	135kg	2 Year
PTB540500			18"	135kg	2 Year
PTB540510	16"	15"	20"	135kg	2 Year
PTB540520			16"	135kg	2 Year
PTB540530			18"	135kg	2 Year
PTB540540			20"	135kg	2 Year
PTB540550	18'	17'	22"	135kg	2 Year
PTB540560			18"	135kg	2 Year
PTB540570			20"	135kg	2 Year
PTB540580	20"	19"	22"	135kg	2 Year
PTB540590			18"	135kg	2 Year
PTB540600			20"	135kg	2 Year
PTB540610	20"	19"	22"	135kg	2 Year
PTB540610			22"	135kg	2 Year



spex<sup>®</sup>



### Manta Ray Back Support

- A lightweight solid aluminium back support to support minimal deformities or stability needs, with quick-release hardware
- Minimal to moderate postural support, for mild-moderate torso asymmetries
- Greater functionality as there is minimal hardware between the client and the lateral supports
- Slick and non-obtrusive, provides right amount of spine and lateral stability for different postural needs
- Fully adjustable and repositionable lateral 'wings' means that the therapist/clinician can ensure the right support in the right place for the user
- Improved trunk/pelvic positioning whilst maintaining propelling efficiency
- Minimal contouring, and includes positioning kit for further postural enhancements

Note: For sizes outside of the codes displayed, please contact your Aidacare Complex Rehab. consultant. (Refer to: Complex Rehab. Overview on pg. 10)

Code	Chair Width	Backrest Height	S.W.L	Warranty
PTB535200	12"	16"	90 kg	2 years
PTB535202	13"	16"	90 kg	2 years
PTB535204	14"	18"	90 kg	2 years
PTB535206	15"	18"	90 kg	2 years
PTB535208	16"	20"	160 kg	2 years
PTB535210	17"	20"	160 kg	2 years
PTB535212	18"	20"	160 kg	2 years
PTB535214	19"	20"	160 kg	2 years
PTB535216	20"	20"	160 kg	2 years



### SuperShape Back Support

- The Supershape Back Support is designed for the individual who:
  - Has complex postural needs, significant spinal or trunk asymmetries or protruding skeletal prominences
  - Risks skin breakdown and has pressure care requirements
  - Requires greater immersion into back support for stability and comfort
- Expansion fabric cover that allows all kind of contouring without compromising skin protection
- Pressure reducing foam surface layer to absorb bony prominences
- Triple-layered cube contouring cell system provides configurations for a perfect fit and shape for the client
- Customisation to contouring are performed on-the-spot, as many times as you want
- Modular componentry means you can 'mix and match' with different lateral pad options and positioning supports
- Deep contour solution which offers exceptional contact to contoured areas of the body



Code	Chair Width	Backrest Width	Backrest Height	S.W.L	Wty.
PTB535374	10"	9"	12"	90 kg	2 years
PTB535376			14"	90 kg	2 years
PTB535378			16"	90 kg	2 years
PTB535380	12"	11"	12"	90 kg	2 years
PTB535382			14"	90 kg	2 years
PTB535384			16"	90 kg	2 years
PTB535386	14"	13"	18"	90 kg	2 years
PTB535388			14"	90 kg	2 years
PTB535390			16"	90 kg	2 years
PTB535392	15"	14"	18"	90 kg	2 years
PTB535394			20"	90kg	2 years
PTB535396	16"	15"	14"	90 kg	2 years
PTB535398			16"	90 kg	2 years
PTB535400			18"	90 kg	2 years
PTB535402	16"	15"	20"	90 kg	2 years
PTB535404			16"	160 kg	2 years
PTB535406			18"	160 kg	2 years
PTB535408			20"	160 kg	2 years
PTB535410			23"	160 kg	2 years

Code	Chair Width	Backrest Width	Backrest Height	S.W.L	Wty.
PTB535412	17"	16"	16"	160 kg	2 years
PTB535414			18"	160 kg	2 years
PTB535416			20"	160 kg	2 years
PTB535418			23"	160 kg	2 years
PTB535420	18"	17"	16"	160 kg	2 years
PTB535422			18"	160 kg	2 years
PTB535424			20"	160 kg	2 years
PTB535426	19"	18"	23"	160 kg	2 years
PTB535428			16"	160 kg	2 years
PTB535430			18"	160 kg	2 years
PTB535432	20"	19"	20"	160 kg	2 years
PTB535434			23"	160 kg	2 years
PTB535436	20"	19"	16"	160 kg	2 years
PTB535438			18"	160 kg	2 years
PTB535440			20"	160 kg	2 years
PTB535442			23"	160 kg	2 years

#### DVA Contact Details

P 1300 888 052 | F 1300 787 052 | E [dva@aidacare.com.au](mailto:dva@aidacare.com.au)



For NDIS Item Code, refer to page: 508





### Vigour Lo Back Support

New invertible shell design means the Vigour Lo can be used either way up on the wheelchair. Sacral and lumbar height support allowing unrestricted upper body range of movement. Designed for the individual who requires:

- A solid back support with the ability to self-propel
- Improved spinal and pelvic positioning whilst maintaining propelling efficiency
- Minimal postural support
- For clients that have mild torso asymmetries
- Approx. Vigour Lo weight is from 0.8 to 1.5kg

**spex**

Code	Chair Width	Backrest Width	Backrest Height	S.W.L	Wty.
PTB535014	10"	9"	6"	90 kg	2 years
PTB535022	11"	10"		90 kg	2 years
PTB535030	12"	11"	7"	90 kg	2 years
PTB535038	13"	12"		90 kg	2 years
PTB535046	14"	13"	8"	90 kg	2 years
PTB535054	15"	14"		90 kg	2 years
PTB535062	16"	15"	10"	160 kg	2 years
PTB535070	17"	16"		160 kg	2 years
PTB535078	18"	17"	11"	160 kg	2 years
PTB535086	19"	18"		160 kg	2 years
PTB535094	20"	19"		160 kg	2 years



### Vigour Mid Back Support

Lightweight and designed for efficient propelling, with scapular subtractions for unimpeded arm function. Designed for the individual who requires:

- A solid back support with the ability to self-propel
- Improved spinal and pelvic positioning whilst maintaining propelling efficiency
- Minimal to moderate postural support
- In combination with lateral supports offers exceptional trunk and thoracic stability
- For clients that have mild torso asymmetries
- Approx. Vigour Mid weight is from 0.9 to 2.5kg

**spex**

Code	Chair Width	Backrest Width	Backrest Height	S.W.L	Wty.
PTB535016	10"	9"	10"	90 kg	2 years
PTB535024	11"	10"		90 kg	2 years
PTB535032	12"	11"	12"	90 kg	2 years
PTB535040	13"	12"		90 kg	2 years
PTB535048	14"	13"	14"	90 kg	2 years
PTB535056	15"	14"		90 kg	2 years
PTB535064	16"	15"	16"	160 kg	2 years
PTB535072	17"	16"		160 kg	2 years
PTB535080	18"	17"	17"	160 kg	2 years
PTB535088	19"	18"		160 kg	2 years
PTB535096	20"	19"		160 kg	2 years



### Vigour Hi Back Support

Solid full height back support available in three heights for maximum trunk and shoulder support. Designed for the individual who requires:

- A solid back support
- Minimal to moderate postural support
- Improved spinal and pelvic positioning whilst maintaining propelling efficiency
- In combination with lateral supports offers exceptional trunk and thoracic stability
- Approx. Vigour Hi weight is from 1 to 3.3kg

**spex**

Code	Chair Width	Backrest Width	Backrest Height	S.W.L	Wty.
PTB535018	10"	9"	14"	90 kg	2 years
PTB535020			16"	90 kg	2 years
PTB535026	11"	10"	14"	90 kg	2 years
PTB535028			16"	90 kg	2 years
PTB535034	12"	11"	16"	90 kg	2 years
PTB535036			18"	90 kg	2 years
PTB535042	13"	12"	16"	90 kg	2 years
PTB535044			18"	90 kg	2 years
PTB535050	14"	13"	18"	90 kg	2 years
PTB535052			20"	90 kg	2 years
PTB535058	15"	14"	18"	90 kg	2 years
PTB535060			20"	90 kg	2 years
PTB535066	16"	15"	20"	160 kg	2 years
PTB535068			23"	160 kg	2 years
PTB535074	17"	16"	20"	160 kg	2 years
PTB535076			23"	160 kg	2 years
PTB535082	18"	17"	20"	160 kg	2 years
PTB535084			23"	160 kg	2 years
PTB535090	19"	18"	20"	160 kg	2 years
PTB535092			23"	160 kg	2 years
PTB535098	20"	19"	20"	160 kg	2 years
PTB535100			23"	160 kg	2 years



**spex**



**Rectangular Back Support**  
Fits between wheelchair canes



**Tshape Back Support**  
Sits in front of wheelchair canes



Note: For sizes outside of the codes displayed, please contact your Aidacare Complex Rehab. consultant. (Refer to: Complex Rehab. Overview on pg. 10)

### Adjustable Backrests

- Easily solve upper torso needs for most wheelchair users with the Spex exceptional upholstery section. Incorporates Spex contouring cube system to allow on-the-spot customisations for torso comfort and asymmetry needs.
- Rectangle shape style fits between the wheelchair canes, while T shape sits in front of the wheelchair canes. New Surface style also sits in front of the canes and gives greater support in the shoulder and pelvic areas.
- Effortless customisations
- On-the-spot adaptations for changing postural needs
- Instant results
- Cubes can be removed and added at any time
- Contouring doesn't move or slip out of adjustment
- Additional contouring support wedges can be used to further enhance the degree of contouring.

Rectangular Shape Code	Tshape Code	Chair Width	Backrest Width	Backrest Height	S.W.L	Warranty
PTB535226	PTB535228	10"	9"	12"	90 kg	2 years
PTB535230	PTB535232			14"	90 kg	2 years
PTB535234	PTB535236			16"	90 kg	2 years
PTB535238	PTB535240	11"	10"	12"	90 kg	2 years
PTB535242	PTB535244			14"	90 kg	2 years
PTB535246	PTB535248			16"	90 kg	2 years
PTB535250	PTB535252	12"	11"	14"	90 kg	2 years
PTB535254	PTB535256			16"	90 kg	2 years
PTB535258	PTB535260			18"	90 kg	2 years
PTB535262	PTB535264	13"	12"	14"	90 kg	2 years
PTB535266	PTB535268			16"	90 kg	2 years
PTB535270	PTB535272			18"	90 kg	2 years
PTB535274	PTB535276	14"	13"	16"	90 kg	2 years
PTB535278	PTB535280			18"	90 kg	2 years
PTB535282	PTB535284			20"	90 kg	2 years
PTB535286	PTB535288	15"	14"	16"	90 kg	2 years
PTB535290	PTB535292			18"	90 kg	2 years
PTB535294	PTB535296			20"	90 kg	2 years
PTB535298	PTB535300	16"	15"	18"	160 kg	2 years
PTB535302	PTB535304			20"	160 kg	2 years
PTB535306	PTB535308			23"	160 kg	2 years
PTB535310	PTB535312	17"	16"	18"	160 kg	2 years
PTB535314	PTB535316			20"	160 kg	2 years
PTB535318	PTB535320			23"	160 kg	2 years
PTB535322	PTB535324	18"	17"	18"	160 kg	2 years
-	PTB535328			20"	160 kg	2 years
PTB535330	PTB535332			23"	160 kg	2 years
PTB535334	PTB535336	19"	18"	18"	160 kg	2 years
PTB535338	PTB535340			20"	160 kg	2 years
PTB535342	PTB535344			23"	160 kg	2 years
PTB535346	PTB535348	20"	19"	18"	160 kg	2 years
PTB535350	PTB535352				160 kg	2 years
PTB535354	PTB535356			23"	160 kg	2 years





# General Wheelchair Accessories



For NDIS Item Code, refer to page: 508



## Gel Knee Protector Buttons

- Provide a soft surface to protect the users knees from bumping against legrests
- Attach to the inside of the legrests on a wheelchair
- Includes mounting hardware



## Gel And Foam Footplate Protector Covers

- Designed to fit over existing footplates on a wheelchair
- Highly efficient at distributing pressure thereby avoiding harmful pressure-related problems

Code	Description	DVA:
PTA508800	Gel Knee Protector Buttons - (3.18) Swing Away Legrests	AP14
PTA508820	Gel Knee Protector Buttons - (3.18) Elevating Legrests	-
PTA508810	Gel Knee Protector Buttons - (1.98) Swing Away Legrest	-
PTA508830	Gel Knee Protector Buttons - (1.98) Elevating Legrest	-

Code	Description	Size	DVA:
PTA508600	Gel Covers (Pair)	203.2 x 152.4 mm	AP14
PTA508610	Gel Covers w/ Adhesive Back (Pair)	203.2 x 152.4 mm	-
PTA508615	Gel Single Piece Cover	279.4 x 228.6 mm	-



## Gel Armrest Pads

- These gel armrest pads are designed to offer the ultimate in comfort and protection to the elbows and wrists
- Incorporating a latex-free, solid gel these armrest pads have a durable neoprene nylon surface
- Additionally they offer the ultimate in comfort, making them the best in interface products.



## Power Wheelchair Tray

- A perspex tray to suit most model power wheelchairs
- It features a unique swing away bracket that allows the tray to be out of the way during transfers

Code	Description	Width	Length	DVA:
PTA508350	Gel Armrest Pads (Pair) 10"	88.9 mm	254 mm	-
PTA508400	Gel Armrest Pads (Pair) 12"	88.9 mm	304.8 mm	AP14
PTA508425	Gel Armrest Pads (Pair) 14"	88.9 mm	355.6 mm	-
PTA508450	Gel Armrest Pads (Pair) 16"	88.9 mm	406.4 mm	AP14

Code	Description	Fits Chair Width
MSP419310	Power Wheelchair Tray	16"
MSP419320	Power Wheelchair Tray	18"
MSP422470	Power Wheelchair Tray	20"



## SmartDrive MX2 + PushTracker

- Provides greater freedom and power to manual chair users
- Ability to travel up hills and over thick carpet
- Lightweight and easy to hook on to manual wheelchairs
- PushTracker app available for both iOS and Android devices
- Folding wheelchair compatibility - simply pull back on the spring-loaded flanges to quickly attach or remove your SmartDrive MX2
- PushTracker monitor with wristband allows easy tracking of day to day propulsion metrics - including push count, coast time, and more

Code	Description	Length	Width	Height	Weight	Wty
WCA858508	SmartDrive MX2 + PushTracker	389 mm	141 mm	242 mm	5.7 kg	2 Years



### Calf Panel

- Aeromesh fabric allows for air circulation and provides comfortable support surface
- Designed to attach to legrest hangers of wheelchairs for lower leg support
- Limited Lifetime Warranty

Code	Description	Length	DVA:
WCA860459	Calf Panel - Small (Fits 12"-15" Seat Width)	800 mm	AP14
WCA860461	Calf Panel - Med. (Fits 15"-19" Seat Width)	900 mm	AP14
WCA860463	Calf Panel - Large (Fits 19"-22" Seat Width)	1000 mm	AP14



### Calf Strap

- Aeromesh fabric allows for air circulation and provides comfortable support strap for legs
- Designed to attach to legrest hangers of wheelchairs for lower leg support
- Limited Lifetime Warranty

Code	Description	Length	DVA:
WCA860464	Calf Strap - Small (Fits 13"-15" Seat Width)	800 mm	AP14
WCA860465	Calf Strap - Med. (Fits 15"-18" Seat Width)	900 mm	AP14
WCA860466	Calf Strap - Large (Fits 18"-22" Seat Width)	1000 mm	AP14



### Shoulder Harness Rear Pull

- Provides shoulder and trunk support
- Laminar Pad construction distributes pressure broadly across shoulders and sternum
- Easy, convenient front adjustment/release
- Limited Lifetime Warranty

Code	Description	DVA:
WCA860468	Shoulder Harness - Small Flat Mount	AP14
WCA860470	Shoulder Harness - Medium Flat Mount	AP14
WCA860472	Shoulder Harness - Large Flat Mount	AP14
WCA860474	Shoulder Harness - Extra Large Flat Mount	AP14



### Stayflex Anterior Trunk Support No Zipper

- Provides dynamic upper body support and comfort with elastic, padded material
- Stabilising lower panel to limit stretching and "riding up"
- Limited Lifetime Warranty

Code	Description	DVA:
WCA860520	W'Chair Harness - Stayflex No Zipper - Small	AP14
WCA860522	W'Chair Harness - Stayflex No Zipper - Medium	AP14
WCA860524	W'Chair Harness - Stayflex No Zipper - Large	AP14
WCA860526	W'Chair Harness - Stayflex No Zipper - X-Large	AP14



### Stayflex Anterior Trunk Support with Zipper

- Provides dynamic upper body support and unparalleled comfort
- Elastic, padded material allows comfortable, controlled movement
- Front zipper for easy access
- Limited Lifetime Warranty

Code	Description	DVA:
WCA860510	Stayflex w/zipper - Small Flat Mount	AP14
WCA860512	Stayflex w/zipper - Medium Flat Mount	AP14
WCA860514	Stayflex w/zipper - Large Flat Mount	AP14
WCA860516	Stayflex w/zipper - Extra Large Flat Mount	AP14



### Pelvic Positioning Belt with Metal Push Button 2 Point

- Two points of attachment to wheelchair
- Suitable for supporting users with low tone or weakness
- Metal push button for secure fit
- Single pull strap for convenient adjustment
- Limited Lifetime Warranty

Code	Description	DVA:
WCA860117	Centre Pull 2 Point - XS Frame Saver Flat Mount	AP14
WCA860121	Centre Pull 2 Point - Small Frame Saver Flat Mount	AP14
WCA860125	Centre Pull 2 Point - Medium Frame Saver Flat Mount	AP14
WCA860129	Centre Pull 2 Point - Large Frame Saver Flat Mount	AP14



### Leg Harness

- Holds each leg at the inner thigh providing efficient resistance to pelvic rotation and obliquity, no pressure on the bladder
- Convenient pull straps for adjustment
- Limited Lifetime Warranty

Code	Description	DVA:
WCA860419	Small 230 mm (Fits 8" - 11" Seat Width)	AP14
WCA860420	Medium 330 mm (Fits 11" - 14" Seat Width)	AP14
WCA860421	Large 380 mm (Fits 14" - 16" Seat Width)	AP14



### Pelvic Positioning Belts with Rehab Latch 2 Point

- Two points of attachment, suitable for supporting users with low tone or weakness
- Rehab latch for easy latch release, single pull strap for convenient adjustment
- Limited Lifetime Warranty

Code	Description	DVA:
WCA860169	Centre Pull 2 Point - Small Frame Saver Flat Mount	AP14
WCA860173	Centre Pull 2 Point - Medium Frame Saver Flat Mount	AP14
WCA860177	Centre Pull 2 Point - Large Frame Saver Flat Mount	AP14



### Pelvic Positioning Belt Non Padded 2 Point

- Non padded pelvic positioning belt
- Secure metal push button attachment
- Single pull strap for adjustment
- Limited Lifetime Warranty

Code	Description	DVA:
WCA860361	Centre Pull 2 Point - Med. Frame Saver Flat Mount	AP14
WCA860365	Centre Pull 2 Point - Large Frame Saver Flat Mount	AP14



### Push Button Security Cover

- Durable covers snap securely onto metal push-button buckles
- Limits user access to release the belt
- Opens instantly with a pen tip
- Limited Lifetime Warranty

Code	Description	DVA:
WCA860412	Security Cover for 1 - 1/2" Buckles	AP14
WCA860413	Security Cover for 2" Buckles	AP14

#### DVA Contact Details

P 1300 888 052 | F 1300 787 052 | E [dva@aidacare.com.au](mailto:dva@aidacare.com.au)



For NDIS Item Code, refer to page: 508



### Ankle Huggers Velcro Attachment

- Provide supportive positioning for the wheelchair users ankles and feet
- Secure velcro attachments to assist in foot and leg positioning
- Includes mounting kit for footplate attachment
- Also available in plastic side release
- Limited Lifetime Warranty

Code	Description	DVA:
WCA860422	Ankle Huggers Velcro Attach - Extra Small	AP14
WCA860423	Ankle Huggers Velcro Attach - Small	AP14
WCA860424	Ankle Huggers Velcro Attach - Medium	AP14
WCA860425	Ankle Huggers Velcro Attach - Large	AP14
WCA860426	Ankle Huggers Velcro Attach - Extra Large	AP14



### Pelvic Positioning Belt with Metal Push Button 4 Point

- Four points of attachment to the wheelchair
- Holds pelvis more aggressively for situations when user has a lot of movement
- Metal push button for secure fit
- Single pull strap for convenient adjustment
- Limited Lifetime Warranty

Code	Description	DVA:
WCA860229	Centre Pull 4 Point - XS Frame Saver Flat Mount	AP14
WCA860233	Centre Pull 4 Point - Small Frame Saver Flat Mount	AP14
WCA860237	Centre Pull 4 Point - Medium Frame Saver Flat Mount	AP14
WCA860241	Centre Pull 4 Point - Large Frame Saver Flat Mount	AP14



### Pelvic Positioning Belt with Rehab Latch 4 Point

- Four points of attachment to the wheelchair
- Holds pelvis more aggressively for situations when user has a lot of movement
- Rehab latch for easy latch release
- Single pull strap for convenient adjustment
- Limited Lifetime Warranty

Code	Description	DVA:
WCA860385	Centre Pull 4 Point - Small Frame Saver Flat Mount	AP14
WCA860389	Centre Pull 4 Point - Med. Frame Saver Flat Mount	AP14
WCA860393	Centre Pull 4 Point - Large Frame Saver Flat Mount	AP14



### Monoflex Anterior Trunk Support

- Soft neoprene chest belt provides stretch and comfort for lateral and anterior support, at the chest or abdominal level
- Side release buckles for adjustment
- Mounting hardware for sling or solid backs included
- Limited Lifetime Warranty

Code	Description	Width	Length	DVA:
WCA860546	Extra Small	76 mm	318 mm	AP04
WCA860547	Small	89 mm	397 mm	AP04
WCA860548	Medium	102 mm	476 mm	AP04
WCA860549	Large	114 mm	556 mm	AP04
WCA860550	Monoflex - Extra Large	127 mm	635 mm	AP04



### Soft Headrest

- Designed for superior comfort and support, the ottobock soft headrest consists of an ABS plastic shell, memory foam and a removable lycra cover.
- Covers available separately
- 1 Year Warranty

Code	Description	Width	Height	DVA:
WCA858810	Soft Headrest - Small	190 mm	150 mm	AP14
WCA858800	Soft Headrest - Large	280 mm	190 mm	AP14



### Combination Headrest

- The combination headrest is a supportive headrest designed to provide extra lateral support to the user
- Made of polyurethane it can be cleaned with gentle soap, a sponge and water
- Requires headrest hardware for wheelchair mounting

Code	Description	Width	Height	Wty	DVA:
WCA858700	Combination Headrest	220 mm	130 mm	1 year	AP14



### Channel Forearm Pad

- Modular system designed to provide functional support for patients with weakness or paralysis of the upper extremities
- Can be directly mounted on the wheelchair armrest and on the elevating swivel unit
- 2 year warranty

Code	Description	Length	Width	DVA:
WCA859000	Channel Forearm Pad - Small	205 mm	105 mm	AP14
WCA858990	Channel Forearm Pad - Medium	290 mm	120 mm	AP14
WCA858980	Channel Forearm Pad - Large	355 mm	120 mm	AP14
WCA859010	Channel Forearm Pad One Piece (no hand pad req.)	460 mm	120 mm	AP14



### Modular Hand Pads

- Modular hand pad attachment to be fitted to custom wheelchairs
- Ensures extra comfort for user
- Moulded PU pad for easy cleaning requirements
- Available in 2 x sizes to fit most wheelchairs

Code	Description	DVA:
WCA859250	Modular Hand Pad - Medium	AP14
WCA859120	Modular Hand Pad - Large	AP14



### Lateral Trunk Support Pads

- Provide optimum trunk control, improving balance, posture and comfort
- Offset correction can be applied to an asymmetric trunk
- Comfortable pressure-reduction padding for moulding

Code	Description	Depth	Height
WCA868926	Narrow Straight - size 1	145 mm	95 mm
WCA868928	Narrow Straight r - size 2	180 mm	95 mm
WCA868934	Narrow Curved - size 1	145 mm	95 mm
WCA868936	Narrow Curved - size 2	180 mm	95 mm
WCA868942	Broad - size 1	130 mm	105 mm
WCA868944	Broad - size 2	140 mm	125 mm



### Hip Belts

- Hand made comfortable pads are water resistance, and adjusters stainless steel
- Durable polyester webbing is 'ridge' woven for maximum grip once adjusted
- Hardware allows a multitude of positioning options

Code	Description	Padding Width
WCA868174	2 Point Padded - Small	360 mm
WCA868173	2 Point Padded - Medium	460 mm
WCA868187	2 Point Padded - Large	560 mm
WCA868179	4 Point Padded - Small	360 mm
WCA868178	4 Point Padded - Medium	460 mm
WCA868191	4 Point Padded - Large	560 mm

Note: For sizes outside of the codes displayed, please contact your Aidacare Complex Rehab. Consultant. (Refer to: Complex Rehab. Overview on pg. 10)



### Square Head Support

- Softly padded foam inner head support, with upholstery covers
- Powerful clamp mechanism allows super-quick release and prevents lateral movement
- Reach multi-adjustable mechanism

Code	Description	Width	Height
WCA868265	Head Support - Square - Small	200 mm	160 mm
WCA868268	Head Support - Square - Large	240 mm	200 mm



### Adjustable Lateral Head Supports

- Angle adjustment in width, depth vertical and horizontal
- Can be installed at the top of the head or at the bottom based on required support

Code	Description	Width	Height
WCA868147	Head Support - Adj Laterals - Small	200 mm	160 mm
WCA868148	Head Support - Adj Laterals - Large	240 mm	200 mm



### Vest Harness

- Greater coverage across for support, low neck design for safety, stomach clearance cut-out for comfort
- Release buckles in all four corners for easy fitting and removal from the user

Code	Description	Harness Height	Harness Width	Neck Cut-Out
WCA868325	Small	320 mm	320 mm	200 mm
WCA868324	Medium	400 mm	400 mm	260 mm
WCA868326	Large	480 mm	480 mm	300 mm



### Foot Positioners

- Provide supportive positioning for the wheelchair users feet
- Durable ABS plastic construction
- Mount directly to wheelchair footplate, Velcro adjustment for securing
- Limited Lifetime Warranty

Code	Description	DVA:
WCA859280	Foot Positioners - Small	AP14
WCA859290	Foot Positioners - Medium	AP14
WCA859300	Foot Positioners - Large	AP14
WCA859310	Foot Positioners - Extra Large	AP14



### Wheelchair Carrier

- Lightweight, removable carrier is mounted to the tow ball of a car
- Can be removed and folded away for convenient storage
- Available for self propelled or transit wheelchairs

Code	Description	Width	Depth	Height	Prod. Wt.	S.W.L	Warranty
WCA858480	Wheelchair Carrier Self Propelled	700 mm	200 mm	550 mm	9 kg	45 kg	1 Year
WCA858500	Wheelchair Carrier Transit	700 mm	200 mm	550 mm	9 kg	45 kg	1 Year



### Cushion It

- The Cushion It Sheepskin Cover can be used directly on a seat or back canvas of a wheelchair
- Can be placed over standard foam cushions to increase pressure care and absorb perspiration

Code	Description	Length	Width	DVA:
PTA521300	Sheepskin Hi Temp - Cushion Seat Back	500 mm	500 mm	AB11



### Wheelchair Footplate Cover

- High quality medical grade sheepskin covers provide natural comfort for any wheelchair
- Provide excellent skin protection and comfort

Code	Description	DVA:
PTA522100	Wheelchair Footplate Cover	AB11
PTA522101	Wheelchair Calf Protector	AB11

CONTACT US  
FOR A BROCHURE



# MAXI WHITEGOODS RANGE

MAXI Shower Chair

MAXI Over Toilet Aid

MAXI Shower Stool



aspire for.....

safety

comfort

support



[www.aspirecare.com.au](http://www.aspirecare.com.au)  
1300 133 120



# Utility & Pan Room

Cross Infection Control

# Contents

- P 312 Range Overview & Cross-Infection Control
- P 313 Washer Sanitisers & Macerators
- P 316 Plasticware & Consumables





## CROSS-INFECTION CONTROL

GETTING TO KNOW



THE DDC RANGE

### BREAKING THE CHAIN OF INFECTION



Infection Control



Water Efficient



Budget Friendly



Energy



Nationally Accredited

WASHER SANITISERS : STEAM DISINFECTION TO > AO 700

#### HOT & COLD WATER SYSTEMS

#### COLD WATER SYSTEMS



Panamatic Optima 3



Panamatic Optima 2



Panamatic Maxi



Panamatic Midi

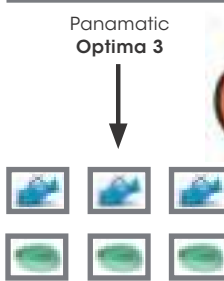

**Capacity:**  
3 Bed Pans &  
3 Urine Bottles



Hands Free  
Opening



**Capacity:**  
2 Bed Pans &  
2 Urine Bottles



Hands Free  
Open, Close & Cycle Start

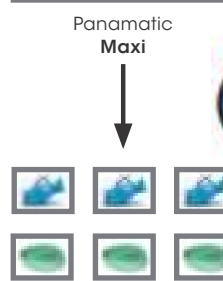

**Capacity:**  
3 Bed Pans &  
3 Urine Bottles



Hands Free  
Opening

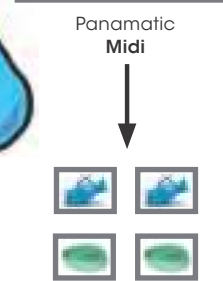

**Capacity:**  
2 Bed Pans &  
2 Urine Bottles



Hands Free  
Open, Close & Cycle Start

### MACERATORS & ACCESSORIES - PRODUCTS FOR DISPOSAL

#### MEDICAL PULP SHAPES (DISPOSABLE)



**PULPMATIC ULTIMA**  
For Maceration of  
Medical Pulp Shapes  
Shown Right



Slipper Pan 1300ml  
UPP100215D  
Plastic Support  
Available



Kidney  
UPP100230D



GP Bowl  
UPP100235D



Slipper Pan 2000ml  
UPP100220D  
Plastic Support  
Available



DDC Washer Sanitisers meet or exceed all the essential performance & design elements of ISO 15883 and AS 4187 (2014) as tested and certified by Australian Certification Services. Efficacy tested & certified by Eurofins AMS Laboratories.



General Enquiries

P 1300 133 120 | E sales@aidacare.com.au | W www.aidacare.com.au



# Washer Sanitisers & Macerators

## SANITISERS



### Panamatic Optima 3

The Panamatic Optima 3 Washer Sanitiser is the hot & cold water version of the Maxi. The large wash chamber accommodates a range of utensils and urine bottles per cycle.

Features:

- Improved wash performance (Hot & cold water)
- Hands-free open, close and start
- Large capacity chamber
- Easier loading

Code	UPM100250
Electrical supply	Single Phase 230 V, 13 AMP
Electrical output/input	Motor - 0.75 KW, Heater - 2.5 KW
Dimensions (w x d x h)	600 x 600 x 900 mm
Water supply	15 mm Hot & Cold water 1 - 6 bar
Soil connection	110 mm connections supplied
Operation cycle time	Approx 5 mins - 30ml Ecowash
Steam disinfection	Exceeds Ao 700, 85° x 75 secs
Typical capacity	3 bedpans + 3 urine bottles/cycle
Warranty	1 Year



Hands free opening



Easier Loading



Greater versatility



### Panamatic Optima 2

The Panamatic Optima 2 Washer Sanitiser (the hot & cold water version of the Midi) has raised the standard to help you meet the ongoing hygiene challenges in the Hospital & Aged Care environments.

Features:

- Improved wash performance (Hot & cold water)
- Efficient water and power use
- Hands-free open, close and start
- MicrobeSafe antimicrobial lid
- Steam disinfection cycle
- Easier loading

Code	UPM100200
Electrical supply	Single Phase 230 V, 13 AMP
Electrical output/input	Motor - 0.75 KW, Heater - 2.5KW
Dimensions (w x d x h)	500 x 600 x 1042 mm
Water supply	15 mm Hot & Cold 1 - 6 bar
Soil connection	110 mm connections supplied
Operation cycle time	Approx 5 mins / 30ml EcoWash
Steam disinfection	Exceeds Ao 700, 85° x 75 secs
Typical capacity	2 bedpans + 2 urine bottles/cycle
Warranty	1 Year



Easier Loading



Hands free cycle start



Hands free opening

#### DVA Contact Details

P 1300 888 052 | F 1300 787 052 | E [dva@aidacare.com.au](mailto:dva@aidacare.com.au)



For NDIS Item Code, refer to page: 508







## Panamatic Maxi

The Panamatic Maxi Washer Sanitiser is the cold water version of the Optima 3. The large wash chamber accommodates a range of utensils and urine bottles per cycle.

Features:

- Cold water wash
- Hands free opening
- Large chamber capacity
- Steam disinfection cycle
- Easier loading

Code	UPM100350
Electrical supply	Single Phase 230 V, 13 AMP
Electrical output/input	Motor - 0.75 KW, Heater - 2.5 KW
Dimensions (w x d x h)	600 x 600 x 900 mm
Water supply	15 mm Cold water 0.5 - 10 bar
Soil connection	110 mm connections supplied
Operation cycle time	Approx 5 mins - 30ml Ecowash
Steam disinfection	Exceeds Ao 700, 85° x 75 secs
Typical capacity	3 bedpans + 3 urine bottles/cycle
Warranty	1 Year



Hands free opening



Easier Loading



Greater versatility



## Panamatic Midi

The Panamatic Midi Washer Sanitiser is the cold water version of the Optima 2.

Features:

- Cold water wash
- Efficient water and power use
- Hands-free open, close and start
- MicrobeSafe antimicrobial lid
- Large chamber capacity
- Easier loading

Code	UPM100300
Electrical supply	Single Phase 230 V, 13 AMP
Electrical output/input	Motor - 0.425KW, Heater - 2.5KW
Dimensions (w x d x h)	500 x 600 x 1042 mm
Water supply	15 mm Cold water 0.5 - 10 bar
Soil connection	110 mm connections supplied
Operation cycle time	Approx 5 mins / 30ml EcoWash
Steam disinfection	Exceeds Ao 700, 85° x 75 secs
Typical capacity	2 bedpans + 2 urine bottles/cycle
Warranty	1 Year



Easier Loading



Hands free cycle start



Hands free opening

## MACERATOR



## Pulpmatic Ultima

The Pulpmatic Ultima Medical Pulp Macerator features cross-infection control combined with improved environmental performance and ease of use.

- Blockage free processing
- Hands-free open, close and start
- Large chamber capacity
- Reduced water consumption
- Automatic sanitation cycle

Code	UPM100120
Electrical supply	Single Phase 230 V, 15 AMP
Motor Output	0.75kW, Noise: 59.5 dba
Dimensions (w x d x h)	500 x 600 x 1042 mm
Water supply	15 mm Cold water 0.5 - 10 bar
Soil connection	50 mm P Trap to 110 mm waste
Operation cycle time	115 seconds / 8ml EcoCleanse
Typical capacity	3 large or 6 small pulp products
Warranty	1 Year



Hands free operation



Hands free opening



Greater capacity



## SEVEN GOOD REASONS FOR CHOOSING A PULPMATIC

1

Pulpmatic Ultima Macerators offer complete **hands-free operation** by means of a foot cup at the base of the machine and an optical sensor to close and start the machine. This makes Pulpmatics not only more convenient, but also more hygienic to use than other macerators & reduces the potential for cross contamination in the sluice room.

2

Pulpmatics offer **greater capacity** than other macerators, made possible by the **unique six-blade maceration** design adopted. In fact, a Pulpmatic's capacity is much greater than some other macerators on the market. Not only does this help you cope better with workload peaks, but it translates into **significant operating cost savings** in terms of staff time & of water and electrical consumption per item processed.

3

In addition to using the latest antimicrobial materials, the Pulpmatic Ultima offers **automatic disinfection** of the internal maceration chamber. The chamber is rinsed thoroughly, not only with water, but also with disinfectant leaving it clean & smelling fresh.

4

Pulpmatics offer **low water consumption**. The short cycle time reduces the volume of water required, saving on an increasingly valuable asset.

5

In addition to machine supply, Aidacare offer an **Installation service** throughout Australia, ensuring smooth progress of your order from point of sale right through to successful commissioning and ongoing care.

6

Pulpmatic Ultima after-sales service is handled by our team of **Service Technicians**, guaranteeing the very best in response times & specialist knowledge. This also means that engineers carry on board any spare parts that may be required, minimising machine downtime.

7

Compatible with all disposable pulp products



Utility & Pan Room

# Plasticware & Consumables



## Wipes & Chemicals



### Antibacterial Wipes

UPW300210

Ecocleanse+ Antibacterial Wipes clean and decontaminate frequently touched items and surfaces. The skin safe wipes are impregnated with a highly effective sanitiser and provide a long lasting impact for improved infection prevention



### Macerator Detergent

UPD300120

KILLS 99% OF BACTERIA AND VIRUSES  
Maximum sanitisation and germ kill.  
Not classified as hazardous. For use in DDC Pulpmatic Macerators



### Sanitiser Detergent

UPD300110

KILLS 99% OF BACTERIA AND VIRUSES  
Maximum sanitisation and germ kill.  
For use in DDC Washer Sanitisers

## Drying Racks



### Stainless Steel 4 Bedpan 4 Urine Bottle Drying Rack

UPA200270

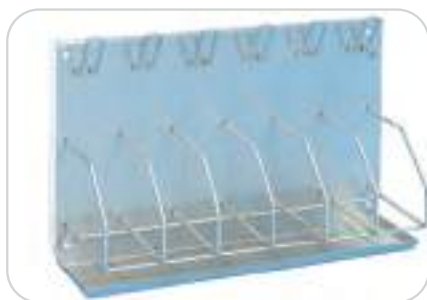

### Stainless Steel 6 Bedpan 6 Urine Bottle Drying Rack

UPA200290



### Stainless Steel Wall Mounted Basin Rack

UPA200280



**Pans & Bowls**



**Bed Pan Slipper**  
BTT148000 - small  
BTT161500 - large



**Bed Pan**  
BTT151800



**Wash Bowls**  
WAT769800 - 600 ml  
WAT770000 - 1500 ml  
WAT761200 - 3500 ml  
WAT769600 - 5500 ml



**Kidney Dishes**  
WAT770700 - 800 ml  
WAT770400 - 700 ml (clear plastic)  
WAT770600 - 600 ml  
WAT770500 - 200 ml



**Urine Bottles**  
BTT148700 - female urinal  
BTT145700 - male urinal (green)  
BTT160900 - male urinal (clear)



**Bowl with Handle & Lid**  
BTC081610



**Bed Pan Liner Support**  
UPP100110



**Slipper Pan Liner Support**  
UPP100115 - Midi  
UPP100120 - Maxi

**Medical Pulp Shapes (Disposable) for Macerators**



**Pulp - Slipper Pan**  
UPP100215D - Midi - 1300 ml  
Packs of 100



**Pulp - Slipper Pan**  
UPP100220D - Maxi - 2000 ml  
Packs of 200



**Pulp - GP Bowl**  
UPP100235D - 1000 ml  
Packs of 400



**Pulp - Kidney dish**  
UPP100230D - 700 ml  
Packs of 600

**Utensil Trays**

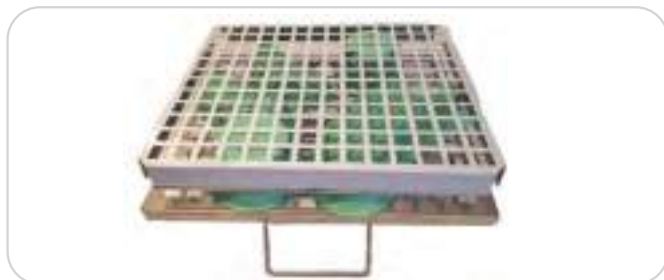

**Optima 3 / Maxi**  
UPA200250



**Optima 2 / Midi**  
UPA200240



Contact us  
for a complete range  
of our Hospital Equipment



# Hospital & Ward Equipment

## Contents

- P 320 Hospital Beds
- P 322 Mattresses - Acute Care
- P 325 Maternity Beds & Birthing
- P 329 Patient Trolleys
- P 331 Examination Couches & Equipment
- P 334 Treatment Chairs
- P 337 Pressure Care Seating
- P 339 Ward Furniture & Seating
- P 342 Patient Transport & Mobility
- P 344 Patient Hygiene
- P 346 Patient Handling - Mobile
- P 351 Patient Handling - Ceiling Hoists
- P 354 Ward Carts
- P 357 Instrument / Dressing Trolleys
- P 359 Other Trolleys & Carts
- P 361 Weigh Chairs & Scales
- P 363 General Ward Equipment



# Hospital Beds



**I ♥ ndis** For NDIS Item Code, refer to page: 508

For more information, please visit our Hospital Equipment Range Catalogue



## Aidacare Elite Ward Bed



- Designed and Manufactured in Europe with both patient and Caregiver in mind
- Provides clinical benefits for patients and easy and intuitive to use
- Split safety sides with integrated controls as standard
- Angle indicators provide easy to read information for crucial head elevation measurement requirements
- Easy to service and maintain, strong, durable and long lasting
- Electric platform, height and Trendelenburg adjustment
- Integrated Bed Extension
- Mechanical CPR by the handles on both sides of back rest
- Electrical CPR in 1 push
- Fowler and Vascular Positions
- Manual knee mechanism by gradual adjustment
- Easily removable fixed head / foot boards and side rails made from polypropylene material
- Standard Inclusions: IV Pole, Catheter Hooks & Integrated Controls in Side Panels



BACK RAISE



LEG RAISE



BACK/LEG RAISE



KNEE BEND



HEIGHT ADJUSTABLE



TRENDELENBURG



Code	Description	Overall Length	Overall Width	Overall Height	Patient Surface Length	Patient Surface Width	Backrest Angle	Knee Bend Angle	Trendelenburg
BEB050130	Elite Ward Bed	2000 - 2200mm	1060mm	385 - 775mm	2000mm	860mm	65°	35°	-14° to 14°
BEA826100	Self Help Pole - Aidacare Elite Ward Bed								
BEA826105	IV Pole - Aidacare Elite Ward Bed								
BEA826110	3/4 Folding Side Rails - Aidacare Elite Ward Bed								
BEA826115	Oxygen Bottle Holder - Aidacare Elite Ward Bed								
GSP504505	Hand Control - Aidacare Elite Ward Bed								

### General Enquiries

P 1300 133 120 | E sales@aidacare.com.au | W www.aidacare.com.au



## Vivo ICU Bed

- Alternating air mattress with full bed integration to maximise therapeutic benefit
- Lateral tilting patient surface
- Patient Anti Slipping System (PAS) offsets the patient movement towards the foot end of the bed during backrest adjustment
- Touch screen panel in the foot end allows for the bed and integrated air mattress functions to be controlled with ease
- Integrated bed extension to suit a range of heights
- Radio transparent patient surface for fluoroscopic examinations
- Intuitive control panels within the gas assisted folding side rails
- Safety alarm system ensures the base of the bed is clear before any movements, preventing entrapment and damage

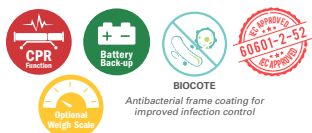

Code	Description	Overall Length	Overall Width	Overall Height	Patient Surface
BEB050100	Vivo ICU Bed	2190 - 2420 mm	1080 mm	480 - 820 mm	2210 x 910 mm



## Botero Bariatric Ward Bed

- Low height of 380mm
- Antibacterial powder coating for improved infection control management
- Backrest translation (autoregression) reduces compression of the thoracic and abdominal areas as the backrest is raised and alleviates shear and pressure for improved skin integrity
- 150mm Tente Castors
- Attendant control panel - intuitive pre-programmed single touch functions for speed and simplicity
- Removable width adjustable head and foot panels
- Compatible with all leading bed movers
- Central locking castors, integrated directional lock
- Full Trendelenburg functionality
- Integrated folding side rails



Code	Description	Overall Length	Overall Width	Overall Height	Patient Surface Length	Patient Surface Width
BEB050200	Botero Bariatric Ward Bed	2260 - 2440 mm	1020 - 1220 mm	380 - 850 mm	2000 - 2180 mm	1020 - 1220 mm
BEM050200	Static Mattress w/ Extension Bolster					
BEA825100	Self Help Pole					
BEA825101	Telescopic IV Pole					



## Aspire Logica Ward Bed

- Feature rich with low minimum height to meet evolving patient handling procedures
- Modern styling to compliment interior design trends
- Compact footprint and lightweight aluminium frame
- 150mm Tente castors
- Central locking brake system with integrated directional lock
- X-Ray compatible mattress deck is available in ABS or compact laminate
- Nurse control panel with security drawer for efficient provision of care
- Single touch programming for common functional requirements such as Cardiac Chair and Fowler positioning
- Integrated bed extension
- Full Trendelenburg functionality
- Gas assisted side rails
- Removable Head and Foot Panels



Code	Description	Overall Length	Overall Width	Overall Height	Patient Surface
BEB050110	Logica Ward Bed	2175 mm	1021 mm	375 - 835 mm	2000 x 900 mm



## Aspire Innova Ward Bed

- Feature rich with low minimum height to meet evolving patient handling procedures
- Modern styling to compliment interior designs
- Compact footprint and lightweight aluminium frame
- 125mm Tente castors
- Central locking brake system with integrated directional lock
- X-Ray compatible mattress deck is available in ABS or compact laminate
- Integrated bed extension
- Nurse control panel with security drawer for efficient provision of care
- Full Trendelenburg functionality
- Compatible with many leading bed movers
- Single touch programming for common functional requirements such as Cardiac Chair and Fowler positioning
- Removable Head and Foot Panels
- Gas assisted side rails



Code	Description	Overall Length	Overall Width	Overall Height	Patient Surface
BEB050120	Innova Ward Bed	2230 mm	1070 mm	365 - 860 mm	2000 x 900 mm



# Mattresses - Acute Care



For NDIS Item Code, refer to page: 508

For more information, please visit our Hospital Equipment Range Catalogue



## Lifecomfort Acute Care Static Mattress

- Castellated surface redistributes shear forces whilst increasing airflow for improved microclimate
- Multi-stretch cover with welded seams for stringent infection control
- Strong high density base and side walls improve patient transfer efficiency
- Side handles allow for easy mattress rotation and movement



Code	Description	Overall Length	Overall Width	Overall Height	Warranty
BEM046615	Single	1980 mm	880 mm	150 mm	5 years foam / 2 years cover
BEM046616	King Single	2030 mm	1050 mm	150 mm	5 years foam / 2 years cover



## Lifecomfort Premier Care Acute Foam Mattress



- Full size memory foam top layer with MEMair™ Breeze open cell foam for improved microclimate
- Castellated second layer for improved comfort
- Pressure care mattress suitable for high risk patients
- Four layer foam support for maximum comfort
- Integrated cotton stockinette promotes foam longevity
- Reinforced side walls for patient stability and ease of transfers
- Inbuilt handles for safe manual handling
- Two way waterproof stretch top cover
- Three sided zipper for easy cover removal
- Heavy duty PVC base cover
- Stitched zipper cover with waterproof flap for improved infection control
- PUPPS 2 (2004) Compliant



Code	Description	Length	Width	Height	Warranty
BEM046735	Premier Care Acute Foam Mattress - Single	2000 mm	900 mm	150 mm	5 years foam / 2 years cover
BEM046740	Premier Care Acute Foam Mattress - King Single	2030 mm	1050 mm	150 mm	5 years foam / 2 years cover

**L** Low Risk - Comfort    **M** Medium Risk - Prevention Management    **H** High Risk - Prevention Management    **V** Very High Risk - Treatment Management

### General Enquiries

P 1300 133 120 | E sales@aidacare.com.au | W www.aidacare.com.au



## Lifecomfort Bariatric Static Mattress

- Four layer foam design caters for bariatric users
- Multi-stretch cover with welded seams, reinforced waterfall flaps and water resistant zippers for stringent infection control
- Side handles allow for easy mattress movement
- Strong high density base and side walls improve patient transfer efficiency



Code	Description	Overall Length	Overall Width	Overall Height	Warranty
BEM046700	Bariatric Static Mattress	2030 mm	1050 mm	200 mm	5 years foam / 2 years cover



## Botero Bariatric Static Mattress

- Two layer foam design with high density base and castellated surface caters to bariatric patients
- Strong high density side walls improve patient transfer efficiency while cut back hinge points allow the mattress to easily move with the mattress platform
- Multi-stretch cover with welded seams for stringent infection control



Code	Description	Overall Length	Overall Width	Overall Height	Warranty
BEM050200	Botero Bariatric Static Mattress	2000 mm	1220 mm	200 mm	5 years foam / 2 years cover



## Lifecomfort Hybrid Acute Static & Alternating Mattress

The Lifecomfort Hybrid Acute (230kg) Mattress Systems offer foam-in-cell technology - enabling flexible operation as either a high comfort foam static support surface or powered-up alternating pressure support surface.

- **Intelligent Hose Management** - when not in use the air-hose can be stored internally, reducing infection control and OH&S issues.
- **Optimised Heel Protection** - a 12° tapered heel zone redistributes pressure up the lower leg, away from the vulnerable heel region. The castellated surface collapses in a wave-like movement reducing shear.
- **Integrated Shear Reduction** - the memory foam overlay moves independently of the underlying cells, reducing shear as the bed profiles.
- **Memory Foam Top Layer** - integrated memory foam overlay improves immersion, envelopment and comfort.



Code	Description	Length	Width	Height	Cells	Warranty
PTM638020	Hybrid Acute - Single	1980 mm	895 mm	170 mm	9 Cells (incl 3x static head cells)	2 years foam / 1 year cover
PTM638025	Hybrid Acute - King Single	1980 mm	1050 mm	170 mm		
PTM638030	Digital Pump					



## Active Air 5 Mattress Overlay

The Active Air 5 provides an effective solution for higher weight users considered to be "At Risk" of Pressure Injury. Featuring AUTO DETECT and INTELLIGENT STATIC MODE which provide lower interface pressure and enhanced comfort, the Active Air 5 is suitable for use in a wide range of care settings from Home Care and Long Term care.

- Breathable multi-stretch cover
- Integrated cable management
- Simple and easy to operate digital pump
- Patented cable lock protection
- Welded seams and zip protection
- 5" Overlay + Foam Mattress



Code	Description	Length	Width	Height	Warranty
PTM639200	Active Air 5 - Single	2000 mm	850 mm	130 mm	2 years foam / 1 year cover
PTM639210	Active Air 5 - King Single	2000 mm	1050 mm	130 mm	
PTM639000	Rapid Inflation Turbo Pump				

**L** Low Risk - Comfort

**M** Medium Risk - Prevention Management

**H** High Risk - Prevention Management

**V** Very High Risk - Treatment Management

### DVA Contact Details

P 1300 888 052 | F 1300 787 052 | E [dva@aidacare.com.au](mailto:dva@aidacare.com.au)



For NDIS Item Code, refer to page: 508



## Active Air 8 Mattress Replacement



The Active Air 8 is a dynamic mattress replacement suitable for users at "High Risk" of Pressure Injury. Featuring AUTODETECT, and AUTOPROTECT, together with CELL-IN-CELL technology, the Active Air 8 provides the highest levels of care into Long Term care environments. The Active Air 8's innovative features ensure lowest interface pressures with an easy-to-use digital pump.

- Breathable multi-stretch cover
- Integrated cable management
- Simple and easy to operate digital pump
- Patented cable lock protection
- Welded seams and zip protection
- 8" Mattress replacement



Code	Description	Length	Width	Height	Warranty
PTM639300	Active Air 8 - Single	2000 mm	900 mm	200 mm	2 years foam / 1 year cover
PTM639310	Active Air 8 - King Single	2000 mm	1050 mm	200 mm	
PTM639000	Rapid Inflation Turbo Pump				



## Active Air 8 Acute Mattress Replacement



The Active Air Acute 8 is a dynamic mattress replacement suitable for users at "Very High Risk" of Pressure Injury. Featuring AUTODETECT, and AUTOPROTECT, together with CELL-IN-CELL technology, the Active Air Acute 8 provides the highest levels of care into Acute and Long Term care environments. The Active Air 8's innovative features ensure lowest interface pressures with an easy-to-use digital pump.

- Breathable multi-stretch cover
- Integrated cable management
- Simple and easy to operate digital pump
- Patented cable lock protection
- Welded seams and zip protection
- 8" Mattress replacement



Code	Description	Length	Width	Height	Warranty
PTM639400	Active Air Acute 8 - Single	2000 mm	900 mm	200 mm	2 years foam / 1 year cover
PTM639410	Active Air Acute 8 - King Single	2000 mm	1070 mm	200 mm	
PTM639000	Rapid Inflation Turbo Pump				



## Active Air Bari 10 Bariatric Mattress Replacement



- Quick Inflation Blower Pump** - High powered mattress pump ensures rapid inflation of mattress & constant high powered air flow for bariatric care.
- Turning Cycle** - With the ability to turn a patient, the BARI 10 ensures for safe patient transfer and lateral movement, improving manual handling and wound therapy outcomes.
- AutoDetect** - Based on the user's weight and size, appropriate pressure output is automatically set, ensuring optimal care and protection
- 1 in 2, 3 or 4 alternating air cycles provides acute level therapy for maximum pressure redistribution and wound management.
- AutoProtect** - When the head of the bed is raised to 45° or more, air pressure automatically increases to prevent bottoming out
- Continuous Low Pressure (CLP)** - When activated, this mode increases user immersion and envelopment
- Workplace Health & Safety** - The power cord is retained within the overlay eliminating its potential as a trip hazard
- Pressure Care Outcomes** - Intelligent cell design maximises the duration of pressure reduction in the alternation cycle



Code	Description	Length	Width	Height	Warranty
PTM639500	Active Air BARI 10 - Single	2000 mm	900 mm	270 mm	2 years foam / 1 year cover
PTM639510	Active Air BARI 10 - King Single	2000 mm	1070 mm	270 mm	
PTM639520	Active Air BARI 10 - Super King Single	2000 mm	1230 mm	270 mm	



# Maternity Beds & Birthing

I ♥ ndis For NDIS Item Code, refer to page: 508

For more information, please visit our Hospital Equipment Range Catalogue



## Aspire Gynaecology Examination Couch



- Transforms from specialised gynaecology, colposcopy, urology position to normal male/female exam couch
- 125mm castors with central locking
- Intuitive Linak hand control and electronics
- Integrated Trendelenburg capabilities

- Integrated gynae cut-out for accessibility
- Electrically adjustable backrest
- Removable padded leg
- Stainless steel bowl
- Healthcare grade upholstery



Code	Description	Overall Length	Overall Width	Overall Height	Backrest Angle	Trendelenburg
BEB050300	Gynaecology Examination Couch	2035 mm	600 mm	550 - 850 mm	0° to 60°	-12° to 12°



## Aspire Gynaecology Delivery Bed



- Electrically adjustable for patient comfort and clinically correct positioning
- 2-section mattress includes multi-stretch cover for patient comfort and improved infection control
- 125mm Tente central locking castors with directional functionality
- Standard inclusions: mattress, IV pole, wall buffers, urine bag holder, belt hooks and accessory slots

- Fast and simple retractable leg section
- Gas assisted side rails minimise transfer gaps
- Linak hand control and electronics
- Integrated Trendelenburg capabilities
- Removable padded leg supports
- Integrated gynae cut-out
- Stainless steel bowl



Code	Description	Overall Length	Overall Width	Overall Height	Backrest Angle	Trendelenburg
BEB050310	Gynaecology Delivery Bed	2175 mm	1060 mm	620 - 890 mm	0° to 63°	-11° to 11°



## Smile Paediatric Ward Bed



- Three function electrically adjustable hospital bed, with capacity to lengthen at the press of a button, designed with growing people in mind
- Durable blow molded side rails with gas spring dampeners for smooth operation

- Biocote antibacterial surface treatment for improved infection control
- Control panel in foot end section
- Onboard battery provides ward mobility and emergency backup



Code	Description	Overall Length	Overall Width	Overall Height	Backrest Angle	Knee Bend Angle	Trendelenburg
PED490100	Smile Paediatric Ward Bed	1830 - 2180 mm	890 mm	550 - 950 mm	0° to 70°	0° to 63°	-15° to 15°

### DVA Contact Details

P 1300 888 052 | F 1300 787 052 | E dva@aidacare.com.au

I ♥ ndis For NDIS Item Code, refer to page: 508





## Matris Rooming-In Crib



- Drop down side sections allow reinforced padded side sections to lay across the gap between crib and bed. This creates a natural and intimate maternal bonding experience and safe lateral transfer of the baby
- Integrated Trendelenburg tilt function to assist with clinical requirements
- Gas assisted height adjustment for ergonomically sound manual handling for mother and baby
- 125mm castors, automatically locking wheels ensure stability and safety with active handle compression required for brake release
- Convenient clothes basket available as accessory (PED490210)
- Biocote antibacterial surface treatment for improved infection control
- Ventilation sections in either end

Code	Description	Overall Length	Overall Width	Overall Height	Trendelenburg
PED490200	Matris Rooming-In Crib	890 mm	520 mm	490 - 710 mm	-6° to 12°

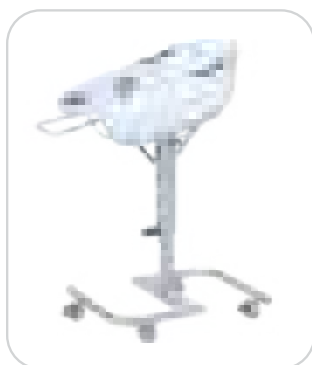

## Aspire Paediatric Cot & Bath - Small



- Compact and lightweight design moves easily and suits even the smallest room layouts
- Gas assisted height adjustment makes patient handling and lifting bath water a simple and ergonomic task
- Convenient storage basket available as accessory (PED490240)
- Hygienic removable bath supports infection control management processes
- Powder coated frame for easy cleaning and infection control management
- Lockable 50mm mobility castors
- Manufactured to AS2130 standard

Code	Description	Overall Length	Overall Width	Overall Height	Trendelenburg
PED490220	Paediatric Cot & Bath - Small	700 mm	500 mm	610 - 860 mm	-20° to 15°



## Aspire Paediatric Cot & Bath - Large



- Compact and lightweight design moves easily and suits even the smallest room layouts
- Gas assisted height adjustment for safe patient handling
- Convenient clothes basket available as accessory (PED490240)
- Powder coated frame for easy cleaning and infection control management
- Lockable 50mm mobility castors on base for ease of transportation
- Manufactured to AS2130 standard

Code	Description	Overall Length	Overall Width	Overall Height	Trendelenburg
PED490230	Paediatric Cot & Bath - Large	870 mm	610 mm	610 - 860 mm	-20° to 15°

### General Enquiries

P 1300 133 120 | E sales@aidacare.com.au | W www.aidacare.com.au



## Aspire Paediatric Cot



- Soft internal edge design with smooth glide side and end panels
- 12° Trendelenburg
- Obstruction free base design for access on all sides and ends, with wall buffers
- 100mm or 125mm castors, with optional turn wheel castors and central locking
- Weightless side panels
- Stainless steel & powder coated aluminium construction



Code	Description	Length	Width	Height	Warranty
WAT830550	Paediatric Cot - Fixed Height	1580 mm	880 mm	1405 mm	5 Years
GSP504120	Mattress - Paediatric Cot			50 mm	



## Aspire Change Table



- Compact footprint for efficient space utilisation
- Durable medical grade vinyl upholstery
- Medical grade foams for durability and patient comfort
- Anterior barrier rail holds mattress securely for a static treatment surface
- Three dump drawers provide additional segmented spaces for consumables management
- Dual cupboards offer large internal storage area
- Laminate finish is easy to clean and durable



Code	Description	Overall Length	Overall Width	Overall Height
WAT822650	Change Table	1100 mm	550 mm	970 mm



## Aspire Paediatric Cot with Trundle Bed



- Integrated adult bed allows parents to room-in with children
- Cot and trundle both offer durable powder coated steel frame with mobility castors
- Integrated drawer and cupboard for essentials
- Quick release vertical side rails slide up and down for simple patient handling
- Manufactured to AS2130 standard



Code	Description	Overall Length	Overall Width	Overall Height	Castor Size
PED490250	Paediatric Table	2060 mm	760 mm	1160 mm	125 mm
(set of 2)	Trundle Bed	1960 mm	760 mm	300 mm	50 mm

### DVA Contact Details

P 1300 888 052 | F 1300 787 052 | E [dva@aidacare.com.au](mailto:dva@aidacare.com.au)



For NDIS Item Code, refer to page: 508



## Aspire Baby Bassinet



- Hospital-grade castors: 100mm castors with lockable levers for enhanced durability, traction and safety.
- Heavy-duty Stainless Steel frame: Wipe clean surfaces adhere to stringent infection control procedures.
- Bassinet: Transparent and durable ABS bassinet provides cradled comfort for newborns.
- Ward label: Asset identification label allows for easily accessible equipment tracking between wards.
- Storage: 2x Polypropylene utility tubs for accessible storage.
- Mattress: Seamless foam mattress with multi-stretch medical grade Carrflex fabric and an in-built mesh extrusion for optimal breathability.

Code	Overall Length	Overall Width	Overall Height (INC. Bassinet)	Bassinet Length	Bassinet Width	Product Weight	SWL
PED490240	795 mm	450 mm	900 mm	710 mm	360 mm	20 kg	30 kg





# Patient Trolleys

I♥ndis For NDIS Item Code, refer to page: 508

For more information, please visit our Hospital Equipment Range Catalogue



## Aspire Advanced Electric Emergency Stretcher



- Electric operated lift, tilt, back raise, Trendelenburg and reverse Trendelenburg functions
- Heavy Duty 225kg Safe Working Load
- Full length sliding X-ray deck ensures complete spinal coverage
- Comfortable 100mm foam mattress with multi-stretch cover
- Safety straps for staff and patient security
- CPR functions integrated on either side for rapid response time
- Collapsible vertical side rails fold away below the patient surface
- Fold-away carer push handles to maximise workspace
- 200mm castors minimise rolling resistance

- Fifth wheel improves steering and reduces manual handling burden in transportation
- Central and Directional Locking functions
- Molded base cover facilitates cleaning and supports infection control processes
- Large corner bumpers minimise wear and tear on equipment and facilities
- Intuitive design and function layout from Red Dot design winning team
- Standard Inclusions: Mattress, IV Pole, O2 Holder, Uring Bag Hooks & Accessory Slots



Code	Description	Overall Length	Overall Width	Overall Height	Patient Surface Length	Patient Surface Width	Backrest Angle	Trendelenburg	Castor Size
TSE674230	Aspire Advanced Electric Emergency Stretcher	2140 mm	840 mm	600 - 910 mm	1920 mm	600 mm	0° to 70°	-12° to 12°	200mm

### DVA Contact Details

P 1300 888 052 | F 1300 787 052 | E [dva@aidacare.com.au](mailto:dva@aidacare.com.au)

I♥ndis For NDIS Item Code, refer to page: 508







## ONEday Electric Hospital Stretcher



- 4-section electric stretcher, with electric Trendelenburg and reverse-Trendelenburg functions
- Alarm system sounds when mains power is lost and when brakes are unlocked
- Trendelenburg functionality from -17° to 17°, backrest angle from 0° to 70° and knee bend angle from 0° to 30°
- Enhanced battery-pack, with day-long operating time, dedicated battery charger for a full and fast recharge
- Quick Release CPR for back rest and knee break
- Antibacterial frame coating 'Biocote' for improved infection control
- Hand Control flexible arm



Code	Description	Overall Length	Overall Width	Overall Height	Patient Surface Length	Patient Surface Width
TSE674100	ONEday Stretcher	1990 - 2170 mm	890 mm	400 - 830 mm	1880 - 2060 mm	710 mm
BEM050300	Static Mattress w/Extension Bolster					
TSE674110	Oxygen Bottle Holder					
TSE674130	Telescopic IV Pole					
TSE674120	Tip-Over Monitor Tray/Writing Desk					



## Aspire Advanced Emergency Stretcher



- Foot operated hydraulic lift, tilt, back raise, Trendelenburg and reverse Trendelenburg functions
- Full length sliding X-ray deck ensures complete spinal coverage
- Safety straps and CPR functions integrated on either side for rapid response time
- 100mm foam mattress with multi-stretch cover
- Collapsible vertical side rails fold away below the patient surface
- Trendelenburg functionality from -12° to 12° and backrest angle from 0° to 90°
- Intuitive design and function layout from Red Dot design winning team



Code	Description	Overall Length	Overall Width	Overall Height	Patient Surface Length	Patient Surface Width
TSE674210	Advanced Emergency Stretcher	2140 mm	840 mm	600 - 910 mm	1955 mm	600 mm
TSE674220	Advanced Emergency Stretcher - Wide	2140 mm	940 mm	600 - 910 mm	1955 mm	700 mm



## Aspire Emergency Stretcher



- Foot operated hydraulic lift, tilt, back raise, Trendelenburg and reverse Trendelenburg functions
- 100mm foam mattress with multi-stretch cover
- CPR functions integrated on either side for rapid response time
- Collapsible horizontal side rails fold away below the patient surface
- Trendelenburg functionality from -12° to 12° and backrest angle from 0° to 70°



Code	Description	Overall Length	Overall Width	Overall Height	Patient Surface Length	Patient Surface Width
TSE674200	Emergency Stretcher	2140 mm	840 mm	590 - 900 mm	1920 mm	600 mm

\*Pictured without Mattress





# Examination Couches & Equipment



For NDIS Item Code, refer to page: 508

For more information, please visit our Hospital Equipment Range Catalogue



## Aspire Tilting Examination Couch



- 2 section height adjustable patient surface also tilts from horizontal to vertical to assist with examinations and promote good posture for the therapist and practitioner
- Durable medical grade vinyl upholstery with robust powder coated steel frame for easy cleaning and sanitising in support of infection control processes
- Medical grade foams for patient comfort and durability
- Linak electronics with intuitive hand control to provide simple and efficient patient handling
- Base frame allows access for lifting devices
- Secure patient safety straps assist with positioning and support
- Gas assisted independent head section movement
- 125mm locking castors



Code	Description	Overall Length	Overall Width	Overall Height	Backrest Angle	Headrest Angle
WAT822630	Tilting Examination Couch	1865 mm	600 mm	560 - 820 mm	0° to 82°	0° to 30°



## Aspire Bobath Therapy Couch



- Designed for rehabilitation involving patients with neurological conditions
- Generous width therapy surface for mobilisation of patients up to 220kg SWL
- Durable medical grade vinyl upholstery with robust powder coated steel frame for easy cleaning and sanitising in support of infection control processes
- Gas assisted independent head section movement
- Linak electronics with intuitive hand control to provide simple and efficient patient handling
- Height adjustable patient surface assists with therapy and examinations
- Medical grade foams for patient comfort and durability
- 125mm locking castors



Code	Description	Overall Length	Overall Width	Overall Height	Backrest Angle
WAT822640	Bobath Therapy Couch	2400 mm	1200 mm	560 - 820 mm	0° to 69°



## Aspire Examination Couch



- 2 Section adjustable height examination couch
- Head section with gas assisted movement for +/- angle adjustment
- Lightweight and compact design with 200mm head end castors for easy maneuvering
- Paper towel roll holder for convenience and hygiene management to avoid cross contamination
- Linak electronics with intuitive hand control
- Durable medical grade vinyl upholstery for easy cleaning
- Castors at foot end are 105mm, and 200mm at head end
- Medical grade foams for durability and patient comfort



Code	Description	Overall Length	Overall Width	Overall Height	Backrest Angle
WAT822620	Examination Couch	2055 mm	650 mm	585 - 935 mm	-62° to 62°

### DVA Contact Details

P 1300 888 052 | F 1300 787 052 | E [dva@aidacare.com.au](mailto:dva@aidacare.com.au)



For NDIS Item Code, refer to page: 508





## Aspire Examination Table

- 2 section fixed height examination table
- Gas assisted head section movement with integrated comfort pillow
- Medical grade vinyl upholstery for easy cleaning
- Medical grade foams for durability and patient comfort
- Robust powder coated steel frame can be cleaned easily in support of infection control processes



Code	Description	Overall Length	Overall Width	Overall Height	Headrest Angle
WAT822600	Examination Table	1860 mm	600 mm	665 mm	0° to 30°



## Aspire Examination Table with Drawers

- 2 section fixed height examination table with drawers
- Gas assisted head section with comfort pillow
- Integrated drawers for management of consumables
- Medical grade vinyl upholstery for easy cleaning
- Stylish timber laminate surround trim to compliment the interior environment
- Medical grade foams for durability and patient comfort
- Robust powder coated steel frame can be cleaned easily in support of infection control processes



Code	Description	Overall Length	Overall Width	Overall Height	Backrest Angle
WAT822610	Examination Table with Drawers	1860 mm	600 mm	665 mm	0° to 30°



## 2 Section Adjustable Examination Couch

- Electric Hi Lo operation by foot switch
- Sleek design with rounded frame legs for safety
- Minimum to maximum height in 30 seconds
- Adjustable head section through dual gas operated struts from -20° to +80°
- Retractable dual locking castors on all 4 castors
- Head section has face hole & plug
- Adjustable feet for uneven surfaces
- 75mm castors for safety and mobility



Code	Description	Length	Width	Height
WAT821550	Exam Couch - 2 Section Electric Hi/Lo - Navy Blue	1950 mm	710 mm	480 - 900 mm



WAT821555

## 3 Section Examination Couch

- Electric Hi Lo operation by foot switch
- Sleek design with rounded frame legs for safety
- Minimum to maximum height in 30 seconds
- Adjustable head section, angle adjustable from -45° to +70° & -90° to +40° (Short Head model)
- Adjustable leg section featuring double gas struts, angle adjustable from -45° to +70° & +0° to +90° (Short Head model)
- Head section has face hole and plug, adjustable feet for uneven surfaces
- Retractable dual locking 75mm castors on all 4 corners



Code	Description	Length	Width	Height
WAT821555	Exam Couch - 3 Section Electric Hi/Lo - Navy Blue	1900 mm	710 mm	500 - 900 mm
WAT821560	Exam Couch - 3 Section Electric Hi/Lo with Short Head - Navy Blue	1950 mm	660 mm	480 - 900 mm



## 5 Section Examination Couch

- Electric Hi Lo operation by foot switch
- Sleek design with rounded frame legs for safety
- Minimum height 550mm to maximum height 900mm in 30 seconds
- Dual motor. 1. Electric Hi Lo 2. Postural drainage
- Adjustable head section featuring single gas strut, angle adjustable from 20° to +45°
- Adjustable leg section featuring double gas struts, angle adjustable from +0° to +80°
- Retractable dual locking 75mm castors on all 4 corners
- Head section has face hole & plug, and adjustable feet for uneven surfaces



Code	Description	Length	Width	Height
WAT821565	Exam Couch - 5 Section Electric Hi/Lo - Navy Blue	1860 mm	660 mm	550 - 950 mm



## Aspire Examination Stool

- Practitioners swiveling Examination Stool with backrest
- Gas assisted height adjustment
- 5 legs with rolling castors for stable maneuverability
- Comfort padded vinyl seat
- Contoured backrest

Code	Description	Overall Height
WAT803850	Examination Stool	560 - 750 mm



## Anaesthetic Stool

- Adjustable height: 490mm - 630mm
- Cushion diameter: 350mm
- Foam thickness: 60mm
- Premium version has additional foot ring

Code	Description	Height	Warranty
WAT803100	Anaesthetic Stool Premium with Foot Ring - Navy	490 - 630 mm	3 Years
WAT803200	Anaesthetic Stool Standard - Navy	490 - 630 mm	3 Years



## Saddle Stool

- Adjustable height: 490mm - 630mm
- Cushion diameter: 350mm
- Foam thickness: 60mm

Code	Description	Height	Warranty
WAT803500	Saddle Stool - Navy	490 - 630 mm	3 Years
WAT803600	Saddle Stool - Black	490 - 630 mm	3 Years



## Post Operative Step

- Single and Double steps for bed access
- Single step - 240mm
- Double step - 220mm and 400mm
- Black, non-slip ribbed rubber surface
- Rubber stoppers for stability



Code	Description	Height
BEA014900	Post Operative Step - Single	240 mm
BEA014800	Post Operative Step - Double	220 mm & 400 mm



Hospital & Ward Equipment



# Treatment Chairs



For NDIS Item Code, refer to page: 508



For more information, please visit our Hospital Equipment Range Catalogue

## Multiline NEXT IT *Infusion Treatment*



A compact therapy couch that effortlessly meets the needs of oncology departments and the demands of infusion and transfusion medicine

Infusion pole holder can be pivoted left and right with just one hand  
*(IV Pole is an optional accessory)*

Inbuilt paper roll holder on push handles

Innovative armrest technology with individual positioning for height, inclination and direction

Low access height of 540mm

4 motor treatment chair (seat height, back recline, seat tilt, leg raise)

Full +/- Trendelenburg functionality & foot control for assistance in emergency situations



100mm central locking castors



Product safety GREINER treatment couches are independently tested and certified



Code	Description	Seat Width	Seat Depth	Seat Height	Backrest Angle	Legrest Angle	S.W.L
CHT100110	Multiline NEXT IT - Navy Blue Vinyl	600 mm	500 mm	540 - 800 mm	-5° to 78°	0° to 90°	220 kg

### General Enquiries

P 1300 133 120 | E sales@aidacare.com.au | W www.aidacare.com.au



## Multiline NEXT DC *Dialysis & Chemotherapy*



Tailored to meet the specific needs of oncology departments and the demands of infusion and transfusion medicine

Inbuilt paper roll holder on push handles

Innovative armrest technology with individual positioning for height, inclination and direction



Product safety  
GREINER treatment  
couches are independently  
tested and certified

Full +/- Trendelenburg  
functionality & foot control  
for assistance in emergency  
situations

100mm central locking castors



5 motor treatment chair (seat height, back recline, seat tilt, leg raise, footrest)



Low access height of 540mm

Infusion pole holder can be pivoted left and right with just one hand  
*(IV Pole is an optional accessory)*

Footrest with automatic, patient-friendly length adjuster (removable)



Code	Description	Seat Width	Seat Depth	Seat Height	Backrest Angle	Legrest Angle	S.W.L
CHT100200	Multiline NEXT DC - Grey Vinyl	600 mm	500 mm	540 - 800 mm	-5° to 78°	0° to 90°	220 kg
CHT100210	Multiline NEXTDC - Navy Blue Vinyl	600 mm	500 mm	540 - 800 mm	-5° to 78°	0° to 90°	220 kg

## Multiline AC *Ambulant Care & Day Surgery Chair*



Ideal for minimally invasive/day surgery; maxillofacial surgery; outpatient surgery; cosmetic facial surgery; post-operation rehabilitation and recovery couch; examination; treatment; mobilisation; transport

Infusion pole holder can be pivoted left and right with just one hand  
*(IV Pole is an optional accessory)*

Low access height of 580mm

Full +/- Trendelenburg functionality & foot control for assistance in emergency situations



Product safety  
GREINER treatment  
couches are independently  
tested and certified

125mm central locking castors



Folding push handles for easy maneuvering

Fold down instrument table

Emergency foot switch for Trendelenburg position, ensuring staff keep their hands free



Code	Description	Seat Width	Seat Depth	Seat Height	Backrest Angle	Legrest Angle	S.W.L
CHT100350	Multiline AC - Navy Blue Vinyl	600 mm	500 mm	580 - 900 mm	-5° to 78°	0° to 90°	220 kg

### DVA Contact Details

P 1300 888 052 | F 1300 787 052 | E [dva@aidacare.com.au](mailto:dva@aidacare.com.au)



For NDIS Item Code, refer to page: 508



## Multiline XXL Bariatric *Bariatric Treatment Chair*



An ideal solution in the bariatric space for: patient transport; examination and treatment; post-op recovery

Uniquely developed for bariatric patients with a body weight of up to 300 kg

All adjustment is electronically controlled for maximum patient comfort and independence, as well as reduced nursing burden

True bariatric transport and treatment solution, with full sit-to-stand functionality

Low access height of 580mm

150mm central locking castors



Folding push handles for easy maneuvering

Infusion pole holder can be pivoted left and right with just one hand  
*(IV Pole is an optional accessory)*

Full +/- Trendelenburg functionality  
*Trendelenburg & shock position shown in image*



Product safety  
GREINER treatment  
couches are independently  
tested and certified



Code	Description	Seat Width	Seat Depth	Seat Height	Backrest Angle	Legrest Angle	S.W.L
CHT100300	Multiline XXL - Black Vinyl	700 mm	570 mm	550 - 800 mm	-5° to 78°	0° to 90°	300 kg



### Medical Side Table BT



- Functional, stable over-chair table that is easy to manoeuvre
- A sturdy frame that can accommodate loads of up to 30kg
- Hassle-free height adjustment with only one hand – even by patients

- Removable trays with recessed edging
- Easy to clean surfaces to facilitate infection control compliance



Code	Description	Overall Length	Overall Width	Height Range	Tabletop Surface Area (LxW)	S.W.L
CHT100050	Medical Side Table BT	970 mm	460 mm	790 - 1040 mm	560 x 390 mm	30 kg



### Medical Side Table BT Plus



- Functional, stable over-chair table that is easy to manoeuvre
- A split table top to allow tilting to 20° or 40° for maximum convenience and functionality - possible on both sides
- A sturdy frame that can accommodate loads of up to 30kg

- Hassle-free height adjustment with only one hand – even by patients
- Removable trays with recessed edging
- Easy to clean surfaces to facilitate infection control compliance



Code	Description	Overall Length	Overall Width	Height Range	Tabletop Surface Area (LxW)	S.W.L
CHT100060	Medical Side Table BT Plus	970 mm	460 mm	790 - 1040 mm	560 x 390 mm	30 kg

# Pressure Care Seating



For NDIS Item Code, refer to page: 508

Brochures available. Please contact us for a copy.



## Aspire Mobile Air Chair



- Unique design promotes skin immersion and envelopment, redistributing skin pressure, reducing the risk of pressure injury associated with prolonged sitting or lying
- Gas Assisted Tilt 25°, Recline 90° and Leg Raise 90°. Allows the chair to convert to a lie-flat bed
- Ergonomic Attendant Grip Handles
- Swing Away Backrest Wings & Armrests. Allows for easy patient side transfers
- Adjustable Foam Matrix. Matrix of collapsible air flow chambers promote skin micro climate management and evenly redistribute pressure.
- Contoured air bladder in the seating surface can be easily inflated and adjusted with integrated hand pump
- Lockable Castors with Directional Control.



Code	Description	Seat Depth	Seat Width	Backrest Height	Seat To Floor Height
CHP198850	Mobile Air Chair - Small / Short	560 mm	410 mm	630 mm	600 mm
CHP198855	Mobile Air Chair - Large / Tall	560 mm	500 mm	630 mm	600 mm
CHP198860	Mobile Air Chair Footrest				
CHP198861	Mobile Air Chair Tray Table				
CHP198862	Mobile Air Chair Rotational Tray Table				



## Aspire Shell Chair



- Compact design allows access under tables for activities. Lightweight frame with anterior tilt function for sit to stand transfers reduces the manual handling
- Forward tilt functionality assists with chair egress and standing transfers. Backwards tilt functionality assists in pressure redistribution and patient stability during transfers
- Ergonomic wing headrest and lumbar cushioning
- 12.5" rear wheels with attendant foot brake, 5" front swivel castors
- Safety Lap Belt, & Attendant Carer Push Handle
- Adjustable Seat Height by up to 80mm
- Genuine Dartex PU Fabric, an anti-bacterial, fire retardant fabric that is high stretch to help manage pressure injury risk



Code	Description	Seat Depth	Seat Width	Seat To Floor Height
CHP198910	Shell Chair - 450 mm Wide	440 mm	450 mm	450 - 530 mm
CHP198915	Shell Chair - 510 mm Wide	470 mm	510 mm	450 - 530 mm
CHP198930	Pillow Headrest			
CHP198925	Footplate			
CHP198920	Retractable Lap Tray			

### DVA Contact Details

P 1300 888 052 | F 1300 787 052 | E [dva@aidacare.com.au](mailto:dva@aidacare.com.au)



For NDIS Item Code, refer to page: 508







## Phoenix Chair

- Effective for seating clients with the following postural conditions: pressure ulcers, reduced upper body tone, kyphosis, scoliosis, muscle contractures and oedema
- Adjustable head support
- Manual and powered options
- Arm height adjustment
- Backrest recline
- Seat depth adjustment
- Removable arms
- Elevating legrest



Code	Description	Seat Depth	Seat Width	Total Height	Backrest Height	Seat to Floor	Unit
CHP197805	Large - Manual	390 - 480 mm	400 - 500 mm	1320 mm	850 mm	600 mm	67 kg
CHP197810	Large - Electric Leg & Tilt	390 - 480 mm	400 - 500 mm	1320 mm	850 mm	600 mm	67 kg
CHP197815	Large - Electric Leg, Recline & Tilt	390 - 480 mm	400 - 500 mm	1320 mm	850 mm	600 mm	67 kg



## Phoenix Chair - Paediatric

- Effective for seating clients with the following postural conditions: risk of pressure injuries, reduced upper body control, kyphosis, scoliosis, muscle contractures, swelling
- Tilt in space, back recline and elevating legrest
- Forward tilt for stand transfers
- Fully adjustable in under 1 minute
- Unique adjustable back and head support
- Shown with electric adjustment option
- Helps manage pressure



Code	Description	Seat Depth	Seat Width	Total Height	Backrest Height	Seat to Floor	Unit
CHP197800	Paediatric - Manual	290 - 380 mm	250 - 400 mm	1220 mm	680 - 830 mm	540 mm	57 kg



## Sorrento Chair

- Effective for seating clients with the following postural conditions: Cerebral palsy, spinal cord injury, head injury, stroke, multiple sclerosis, Parkinson's disease, motor neurone disease, dementia, Alzheimer's disease
- Optional lateral supports and supportive pillows can help to maintain or improve posture
- Adjustable back angle recline
- Seat depth adjustment
- Elevating legrest
- Tilt in space

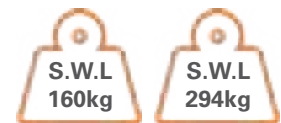

Code	Description	Seat Depth	Seat Width	Total Height	Backrest Height	Seat to Floor	Unit
CHP197822	Standard - 160kg	380 - 480 mm	350 - 600 mm	1320 mm	750 mm	600 mm	62 kg
CHP197823	Bariatric - 294kg	410 - 660 mm	550 - 850 mm	1320 mm	750 mm	600 mm	120 kg



## Atlanta Chair

- Effective for seating clients with the following postural conditions: Huntington's disease, Alzheimer's, lower limb oedema, cellulitis, advanced dementia, Parkinson's disease, brain injury
- Variable angle legrest
- Arm height adjustment
- Removable seat cushion
- Sliding footplate
- Tilt and recline
- Push handle



Code	Description	Seat Depth	Seat Width	Total Height	Backrest Height	Seat to Floor	Unit
CHP197820	Atlanta Chair	480 mm	380 - 500 mm	1135 mm	750 mm	540 mm	67 kg



## Monaco Chair

- Effective for seating clients with the following postural conditions: Minor stroke, reduced mobility, poor sitting balance, lower limb swelling and oedema, post operative rehab needs, pressure management needs, postural problems
- Ideal for users with reduced mobility or sitting balance
- Unique angle adjustable seat
- Adjustable back angle recline
- Pressure management materials
- Padded Waterfall back
- Optional lateral supports



Code	Description	Seat Depth	Seat Width	Total Height	Backrest Height	Seat to Floor	Unit
CHP197827	Monaco Chair	350 - 550 mm	380 - 600 mm	1205 mm	800 mm	350 - 500 mm	57 kg



# Ward Furniture & Seating

**I ♥ ndis** For NDIS Item Code, refer to page: 508

For more information, please visit our [Hospital Equipment Range Catalogue](#)



## Aspire Happy Recliner Chair



- The Happy Recliner Chair offers a comfortable seating surface in-room or in a mobile configuration
- Intuitive recline mechanism for patient independence
- Adjustable padded neck pillow for postural support

- Mobility castor option for patient transportation
- Comfortable padded arms with tapered front upright for improved table access
- Lightweight and easy to move



Code	Description	Overall Height	Overall Width	Overall Depth	Seat Height	Seat Width	Seat Depth	Backrest Height
CHP198820	Beige Vinyl	1080 mm	690 mm	780 mm	420 mm	520 mm	580 mm	660 mm



## Aspire Happy Sleeper Chair



- Facilitates the important role that family and friends play in the recovery process
- Durable seat construction preserves shape and comfort in a high use environment
- Completely flat sleep surface to maximise rest

- Intuitive single hand activation allows effortless conversion from chair to a comfortable sleep surface
- Recessed locking castors offer easy positioning and accessibility



Code	Description	Overall Height	Overall Width	Overall Depth	Seat Height	Seat Width	Seat Depth	Backrest Height
CHP198810	Beige Vinyl	780 mm	760 mm	960 mm	370 mm	600 mm	580 mm	410 mm
CHP198812	Teal Vinyl	780 mm	760 mm	960 mm	370 mm	600 mm	580 mm	410 mm
CHP198814	Light Blue Vinyl	780 mm	760 mm	960 mm	370 mm	600 mm	580 mm	410 mm
CHP198816	Navy Blue Vinyl	780 mm	760 mm	960 mm	370 mm	600 mm	580 mm	410 mm



## Aspire Happy Dialysis Chair



- The Happy Dialysis Chair offers a comfortable seating surface in-room or in a mobile configuration for infusion therapy
- Tapered fold down armrests promote comfort and accessibility during infusion therapy
- Intuitive recline mechanism for patient independence

- Mobility castor option for patient transportation
- Lightweight and easy to move promoting workplace health and safety
- IV pole mounted to rear of chair



Code	Description	Overall Height	Overall Width	Overall Depth	Seat Height	Seat Width	Seat Depth	Backrest Height
CHT100400	Beige Vinyl	1080 mm	690 mm	780 mm	420 mm	520 mm	580 mm	660 mm

Hospital & Ward Equipment

### DVA Contact Details

P 1300 888 052 | F 1300 787 052 | E [dva@aidacare.com.au](mailto:dva@aidacare.com.au)

**I ♥ ndis** For NDIS Item Code, refer to page: 508





**Aspire High Back Classic Day Chair**

Code	Description
CHP208050	Champagne Vinyl
CHP208055	Slate Vinyl



**Aspire Adjustable Day Chair**

Code	Description
CHP208025	Latte Vinyl
CHP208030	Ink Vinyl



**Aspire MAXI Day Chair**

Code	Description
CHP213500	Burgundy Vinyl



**Aspire Waterfall Day Chair**

Code	Description
CHP208070	Ink Vinyl
CHP208071	Latte Vinyl
CHP208075	Oatmeal Fabric
CHP208076	Mocha Fabric



**Aspire Low Back Classic Day Chair**

Code	Description
CHP208000	Champagne Vinyl
CHP208005	Slate Vinyl



**Aspire Classic Bedside Commode**

Code	Description
BEC045005	Champagne Vinyl
BEC045006	Slate Vinyl



**Aspire Deluxe Bedside Commode**

Code	Description
BEC045115	Champagne Vinyl
BEC045116	Slate Vinyl



**Aspire Kitchen/Perching Stool**

Code	Description
CHP213500	Champagne Vinyl



**Aspire Transport Legs with Wheels**

Code	Description
CHP208090	Compatible with - Aspire High Back, Waterfall & Adjustable Day Chairs



**Aspire Footrest**

Code	Description
CHP208080	Champagne Vinyl
CHP208085	Slate Vinyl



**Aspire Recessed Top Overbed Table**

Code	Description
BEA028000	Beige Frame + Recessed Cream Table Top



**Aspire Recessed Split Top Overbed Table**

Code	Description
BEA028100	Beige Frame + Recessed Split Cream Table Top

For Detailed Day Chair Range See Page 109



**Aspire Standard Laminate Overbed Tables**

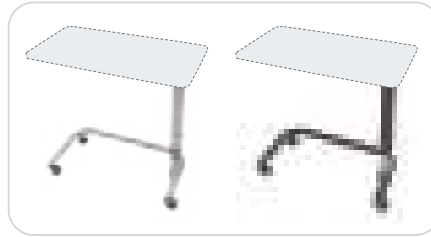

**Aspire Custom Laminate Overbed Tables**

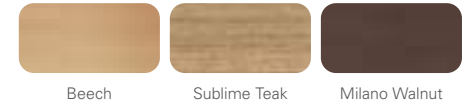

Code	Description
BEA006700	Beige Frame + White Table Top
BEA006701	Beige Frame + Beech Table Top

Code	Description
BEA006685	Frame - Gunmetal Grey
BEA006690	Frame - Beige
BEA006693	Table Top - White

Code	Description
BEA006694	Table Top - Beech
BEA006695	Table Top - Sublime Teak
BEA006696	Table Top - Milano Walnut



**Aspire Premium Overbed Table**



**Aspire Premium Split Top Overbed Table**



**Aspire Bedside Cabinet**  
*1 Drawer + 1 Door - Compact*

Code	Description
BEA006710	Premium Overbed Table

Code	Description
BEA006720	Premium Split Top Overbed Table

Code	Description
BEA827090	1 Drawer + 1 Door - Compact



**Aspire Bedside Cabinet**  
*2 Drawer + 1 Shelf - Compact*



**Aspire Bedside Cabinet**  
*2 Drawer - Compact*

Code	Description
BEA827110	2 Drawer + 1 Shelf - Compact

Code	Description
BEA827120	2 Drawer - Compact



# Patient Transport & Mobility



For NDIS Item Code, refer to page: 508



For more information, please visit our Hospital Equipment Range Catalogue



## Aspire Assist 2 - WARD Vinyl



- Hospital grade fire retardant vinyl is easily sanitised for infection control
- Robust folding steel frame can also be fixed to stop chair folding - optional mod available (AAL848590)
- Swing-back, removable armrests and swing-away, removable legrests

- Quick release, solid 24" tyres and 8" height adjustable castors
- Push-to-lock brakes
- Height adjustable footrests



Code	Description	Seat Width	Seat Depth	Seat Height
MWS449340	Assist 2 WARD - 350 mm (14")	350 mm	400 mm	460 - 500 mm
MWS449350	Assist 2 WARD - 400 mm (16")	400 mm	400 mm	460 - 500 mm
MWS449360	Assist 2 WARD - 450 mm (18")	450 mm	400 mm	460 - 500 mm
MWS449370	Assist 2 WARD - 500 mm (20")	500 mm	400 mm	460 - 500 mm
MWS449380	Assist 2 WARD - (HD) - 570 mm (22")	570 mm	400 mm	460 - 500 mm
MWS449390	Assist 2 WARD - (HD) - 610 mm (24")	610 mm	400 mm	460 - 500 mm



## Aspire Swish Ward Transport Chair



- Multi-position patient transport chair offers both leg elevation and backrest recline and adjustable headrest
- Patient accessible recline function for independence
- Slide out durable compact laminate footplate promotes patient safety and mobility
- Rear mounted full width foot brake lever

- Safety spring in footplate allows for standing transfers without tipping the chair
- Carer push handle and operation levers
- Padded PU swing back armrests
- 300mm solid front wheels and 125mm rear castors



Code	Description	Overall Height	Overall Width	Overall Depth	Seat Height	Seat Width	Seat Depth	Recline Angle	Leg Raise Angle
MWS450100	Swish Ward	1130mm	643 mm	1000 mm	410 mm	500 mm	440 mm	0° to 90°	0° to 90°



## Aspire Swish HD Ward Transport Chair



- Multi-position heavy duty patient transport chair offers both leg elevation and backrest recline and adjustable headrest
- Slide out durable compact laminate footplate promotes patient safety and mobility
- 300mm solid front wheels and 125mm rear twin castors

- Patient accessible recline function for independence
- Safety spring in footplate allows for standing transfers without tipping the chair
- Carer push handle and operation levers
- Padded PU swing back armrests
- IV pole included as standard

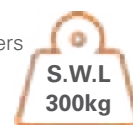

Code	Description	Overall Height	Overall Width	Overall Depth	Seat Height	Seat Width	Seat Depth	Recline Angle	Leg Raise Angle
MWS450200	Swish HD	1130mm	743 mm	1000 mm	410 mm	600 mm	440 mm	0° to 90°	0° to 90°

### General Enquiries

P 1300 133 120 | E sales@aidacare.com.au | W www.aidacare.com.au

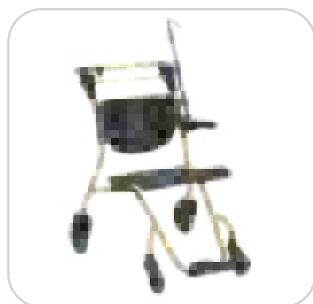

## Aspire Ward Transfer Chair



- Lightweight rigid design indoor ward transfer chair with comfort seating
- Clean and accessible design is easily sanitised for infection control
- Stackable design to maximise utilisation of space and maintain safe workflows - see Park Station
- Automatic and attendant braking ensures patient safety
- Frame colour differentiation allows rapid identification of hospital assets
- Swing back arms and generous seat offer comfort and support to a wide range of users
- Contoured back and seat promote correct sitting posture
- Molded PU padded surfaces are durable and easy to clean
- Optional security token access improves asset management
- Sprung flip up footplate for easy entry and egress
- IV Pole with height adjustment

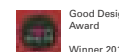

Code	Description	Seat Width	Seat Depth	Seat Height
MWS449900	Ward Transfer Chair	470 mm (18")	430 mm	455 mm
MWS449910	Park Station			



## Aspire Assist 2 - Everyday



## Aspire Transit 2 - Transporter



## Aspire Evoke 2 - Lightweight & Highly Adjustable

Code	Description
MWS449300	Assist 2 - 350 mm (14")
MWS449310	Assist 2 - 400 mm (16")
MWS449320	Assist 2 - 450 mm (18")
MWS449330	Assist 2 - 500 mm (20")

Code	Description
MWS449410	Transit 2 - 400 mm (16")
MWS449420	Transit 2 - 450 mm (18")
MWS449430	Transit 2 - 500 mm (20")

Code	Description
MWS449500	Evoke 2 - 350 mm (14")
MWS449510	Evoke 2 - 400 mm (16")
MWS449520	Evoke 2 - 450 mm (18")
MWS449530	Evoke 2 - 500 mm (20")
MWS449540	Evoke 2 (HD) - 570 mm (22")
MWS449550	Evoke 2 (HD) - 610 mm (24")



## Aspire Evoke 2 JNR



## Aspire Rehab RX JNR



## Aspire Rehab RX - Advanced Tilt-In-Space

Code	Description
MWS449560	Evoke 2 JNR

Code	Description
MWS449630	Rehab RX JNR

Code	Description
MWS449710	Rehab RX - 410 - 460 mm (16 - 18")
MWS449720	Rehab RX - 460 - 510 mm (18 - 20")
MWS449740	Rehab RX - 510 - 560 mm (20 - 22")



## Aspire Rehab RS - Classic Tilt-In-Space



## Heavy Duty Wheelchair



## Super Heavy Duty Wheelchair

Code	Description
MWS449600	Rehab RS - 410 to 460 mm (16-18")
MWS449610	Rehab RS - 460 to 510 mm (18-20")
MWS449620	Rehab RS - 510 to 560 mm (20-22")

Code	Description
MWS442910	S.W.L 136kg - 500 mm (20")
MWS442911	S.W.L 204kg - 550 mm (22")
MWS442912	S.W.L 204kg - 600 mm (24")

Code	Description
MWS442901	S.W.L 318kg - 650 mm (26")
MWS442902	S.W.L 318kg - 700 mm (28")

For Detailed Wheelchair Range See Page 272

# Patient Hygiene



For NDIS Item Code, refer to page: 508



For more information, please visit our [Hospital Equipment Range Catalogue](#)



## Aspire Hydraulic Shower Trolley

- Comfortable, padded and waterproof patient surface with welded seams for infection control
- Internal patient surface 1950mm x 600mm
- Height adjustable from 500mm to 775mm making sideways slide transfers a simple process
- Wall buffers promote durability and limit facility wear

- Integrated hydraulic Trendelenburg tilt function aids patient positioning and water drainage
- Central locking mechanism with directional lock functionality
- Hospital grade 125mm castors
- Durable stainless steel frame



Code	Description	Overall Length	Overall Width	Overall Height
BTS148100	Hydraulic Shower Trolley	2150 mm	840 mm	500 - 775 mm



## Electric Shower Trolley

- Epoxy powder coated frame with curved base construction to allow easy access for carers
- Stainless Steel and P.V.C top frame with padded, vinyl mattress
- Electric tilt 8°, Electric Trendelburg Tilt, Electric high-low operation of 600 - 1000mm
- 125mm total lock castors for manoeuvrability and stability

- Ergonomic push handle and wall corner buffer discs
- Liner can be secured in the corners to facilitate in bath
- Plug-in rechargeable battery pack



Code	Description	Overall Length	Overall Width	Overall Height
BTS147100	Electric Shower Trolley - Standard	1890 mm	730 mm	600 - 1000 mm



## Aspire Weight Bearing Platform Commode - 460mm



## Aspire Swing Away Footrest Commode - 460mm



## Aspire Weight Bearing Platform Commode - 530mm

Code	Description
BTC066000	Attendant Propelled
BTC066200	Self Propelled

Code	Description
BTC065900	Attendant Propelled
BTC066100	Self Propelled

Code	Description
BTC066050	Attendant Propelled
BTC066055	Self Propelled

### General Enquiries

P 1300 133 120 | E [sales@aidacare.com.au](mailto:sales@aidacare.com.au) | W [www.aidacare.com.au](http://www.aidacare.com.au)



**Aspire  
Swing Away  
Footrest  
Commode  
- 530mm**

Code	Description
BTC066060	Attendant Propelled
BTC066065	Self Propelled



**Aspire Weight  
Bearing  
Platform  
Commode  
- 600mm**

Code	Description
BTC061400	Attendant Propelled



**Aspire  
Swing Away  
Footrest  
Commode  
- 600mm**

Code	Description
BTC061300	Attendant Propelled
BTC061305	Self Propelled



**Aspire  
Tilt & Recline  
Shower  
Commode**

Code	Description
BTC066030	Tilt & Recline - 560 mm
BTC066040	Tilt & Recline - 630 mm



**Aspire  
Bariatric  
Shower  
Commode**

Code	Description
BTC061200	Bariatric Shower Commode

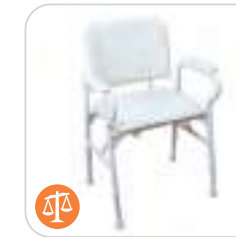

**Aspire  
MAXI  
Shower  
Chair**

Code	Description
BTS118020	MAXI Shower Chair



**Aspire  
MAXI Over  
Toilet Aid**

Code	Description
BTT145020	MAXI Over Toilet Aid

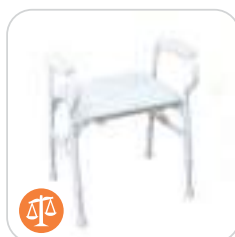

**Aspire  
MAXI  
Shower  
Stool**

Code	Description
BTS119030	MAXI Shower Stool



**Aspire  
Toilet  
Surround  
Frame**

Code	Description
BTT155100	Toilet Surround Frame



**Aspire  
Shower  
Chair**

Code	Description
BTS118000	Regular - Steel
BTS118005	Regular - Aluminium
BTS118010	Wide - Steel
BTS118015	Wide - Aluminium



**Aspire Over  
Toilet Aid**

Code	Description
BTT145000	Regular - Steel
BTT145005	Regular - Aluminium
BTT145010	Wide - Steel
BTT145015	Wide - Aluminium



**Aspire  
Shower  
Stool**

Code	Description
BTS119000	Regular - Steel
BTS119005	Regular - Aluminium
BTS119020	Regular - Steel + Padded Seat
BTS119025	Regular - Steel + Padded Seat and Back
BTS119010	Wide - Steel
BTS119015	Wide - Aluminium



**Aspire Toilet Seat Raiser**

Code	Description	Code	Description
BTT149800	50 mm - No Lid	BTT149900	50 mm - With Lid
BTT150200	100 mm - No Lid	BTT150100	100 mm - With Lid
BTT150300	150 mm - No Lid	BTT150400	150 mm - With Lid

For any Aspire Shower Commode Accessories, please visit page 24

For any Aspire Toilet & Showering needs, please visit page 32





# Patient Handling - Mobile



For NDIS Item Code, refer to page: 508

Exclusive to:



For more information, please visit our Hospital Equipment Range Catalogue



## Golvo 9000 Patient Lifter



- Vertical lifting motion with flexible lift strap is ideal for horizontal lifting, ambulation and lifting from the floor
- Parallel base-width adjustment contributes to easier lifting of patients to/from chairs, beds and the floor
- User display highlights device usage, including lift count, service required indicator and overloads
- Optional quick-release hook system allows for easy and rapid change a sling bar to a scale



Code	Description	Overall Height	Overall Length	Overall Width	Lifting Height
LSS393100	Golvo 9000 Patient Lifter - Aluminium, Electric Leg Function	2090 mm	1185 mm	735 - 1020 mm	571 - 1816 mm



## Golvo 9000 LowBase Patient Lifter



- LowBase version allows for even greater clearance under low beds or stretchers versus the standard model
- Vertical lifting motion with flexible lift strap is ideal for horizontal lifting, ambulation and lifting from the floor
- User display highlights device usage, including lift count, service required indicator and overloads
- Parallel base-width adjustment contributes to easier lifting of patients or residents to/from chairs, beds and the floor
- Optional quick-release hook system allows for easy and rapid change a sling bar to a scale



Code	Description	Overall Height	Overall Length	Overall Width	Lifting Height
LSS393105	Golvo 9000 LowBase Patient Lifter - Aluminium, Electric Leg Function	2090 mm	1185 mm	745 - 1028 mm	571 - 1816 mm



## Viking M Patient Lifter



- Informative control box displays number of lift cycles, battery level, lift overload and service indicator
- Optional armrests help support patients during ambulation as well as making it easier for caregivers to manoeuvre the lift (LSS370402)
- Three variable height settings
- Optional quick-release hook system which means caregivers can easily and rapidly change a slingbar or install a scale
- Intuitive and ergonomically-designed hand control
- Ideal for meeting the lifting needs in small spaces



Code	Description	Overall Height	Overall Length	Overall Width	Lifting Height
LSS393190	Viking M Patient Lifter - Aluminium, Electric Leg Function	1340 - 2020 mm	1230 mm	690 - 1110 mm	420 - 1790 mm

### General Enquiries

P 1300 133 120 | E sales@aidacare.com.au | W www.aidacare.com.au



## Viking L Patient Lifter

- Informative control box displays number of lift cycles, battery level, lift overload and service indicator
- Optional quick-release hook system
- Optional armrests help support patients during ambulation (LSS370402)

- Intuitive and ergonomically-designed hand control incorporates indicators for low battery level and when the Safe Working Load of the lift is exceeded
- An everyday flexible lifting solution



Code	Description	Overall Height	Overall Length	Overall Width	Lifting Height
LSS393180	Viking L Patient Lifter - Aluminium, Electric Leg Function	2030 mm	1360 mm	695 - 1070 mm	460 - 1790 mm



## Viking XL Patient Lifter

- Ideal for bariatric lifts and transfers
- Universal TwinBar 670 Slingbar offers additional sling space for patients of size
- Informative control box displays number of lift cycles, battery level, lift overload and service indicator
- Optional quick-release hook system
- Optional armrests help support patients (LSS370402)

- Intuitive and ergonomically-designed hand control incorporates indicators for low battery level and when the Safe Working Load of the lift is exceeded



Code	Description	Overall Height	Overall Length	Overall Width	Lifting Height
LSS393170	Viking XL Patient Lifter - Aluminium, Electric Leg Function	2110 mm	1420 mm	815 - 1130 mm	540 - 1910 mm



## Sabina II EE Standing Lifter

- Conventional patient lifting to a limited extent, lifting in the sitting position
- Powerful lifting motor ensures the smooth raising and lowering of patients
- Base-width adjustment offers greater flexibility of use when lifting from a bed or chair, enhancing patient mobility

- The lower leg support and the foot rest can easily be removed for cleaning
- Adjustable height settings accommodate a variety of different patient sizes



Code	Description	Overall Height	Overall Length	Overall Width	Lifting Height
LSS393250	Sabina II EE Standing Lifter - Steel, Electric Leg Function	900 - 1000 mm	1060 mm	695 - 1115 mm	1050 - 1725 mm



## RollOn Standing and Positioning Aid

- Sit to stand mobile aid supporting patients in mobilising themselves
- Padded rear supports provide security and are easily positioned and adjusted
- Safety lock ensures rear supports remain in an ideal position

- Crafted from aluminium for a lightweight design
- Width-adjustable base for optimal adaptability
- Lockable dual castors ensure stable positioning and usage



Code	Description	Overall Height	Overall Length	Overall Width
LSS393360	RollOn Standing and Positioning Aid - Aluminium, Manual Leg Function	1410 mm	890 mm	620 - 900 mm

For any Liko Lifter & Sling Accessories, please visit page 196



## Slings for Basic Needs



**Original Highback Sling**  
*with Head Support*

Code	Description
LSS394610	Polyester (Loops) - XS - 200kg
LSS394620	Polyester (Loops) - SML - 200kg
LSS394630	Polyester (Loops) - MED - 200kg
LSS394640	Polyester (Loops) - LRG - 200kg
LSS394650	Polyester (Loops) - XL - 300kg
LSS394660	Mesh (Loops) - XS - 200kg
LSS394670	Mesh (Loops) - SML - 200kg
LSS394680	Mesh (Loops) - MED - 200kg
LSS394690	Mesh (Loops) - LRG - 200kg
LSS394700	Mesh (Loops) - XL - 300kg



**Soft Original Highback Sling**  
*with Head Support*

Code	Description
LSS394560	Polyester (Loops) - MED Slim - 200kg
LSS394570	Polyester (Loops) - MED - 200kg
LSS394580	Polyester (Loops) - LRG - 200kg
LSS394590	Polyester (Loops) - XL - 500kg
LSS394600	Polyester (Loops) - XXL - 500kg

## Slings for Toileting & Hygiene



**Hygiene Sling**

Code	Description
LSS394480	Polyester (Loops) - SML - 200kg
LSS394490	Polyester (Loops) - MED - 200kg
LSS394500	Polyester (Loops) - LRG - 200kg
LSS394510	Polyester (Loops) - XL - 300kg



**HygieneVest Toileting Sling**

Code	Description
LSS394220	Polyester (Loops) - SML - 200kg
LSS394230	Polyester (Loops) - MED - 200kg
LSS394240	Polyester (Loops) - LRG - 200kg
LSS394250	Polyester (Loops) - XL - 200kg

## Paediatric Slings

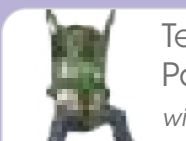

**TeddySling Paediatric Sling**  
*with Head Support*

Code	Description
LSS394100	Polyester (Loops) - XS - 50kg
LSS394110	Polyester (Loops) - SML - 50kg

## Slings for Increased Needs



**UltraSling Bariatric Sling**

Code	Description
LSS394400	Polyester (Loops) - SHORT - 500kg
LSS394410	Polyester (Loops) - REG - 500kg
LSS394420	Polyester (Loops) - LONG - 500kg
LSS394430	Mesh (Loops) - REG - 300kg



**ComfortSling with Head Support**

Code	Description
LSS394710	Mesh (Loops) - MED - 200kg
LSS394720	Mesh (Loops) - LRG - 200kg
LSS394730	Mesh (Loops) - XL - 300kg



**Silhouette Sling with Head Support**

Code	Description
LSS394450	Mesh (Loops) - XS - 200kg
LSS394460	Mesh (Loops) - SML - 200kg
LSS394470	Mesh (Loops) - MED - 200kg
LSS394440	Mesh (Loops) - LRG - 200kg



**Amputee Sling**

Code	Description
LSS394514	Polyester (Loops) - SML - 200kg
LSS394516	Polyester (Loops) - MED - 200kg
LSS394518	Polyester (Loops) - LRG - 200kg



**Amputee Sling with Head Support**

Code	Description
LSS394520	Polyester (Loops) - SML - 200kg
LSS394530	Polyester (Loops) - MED - 200kg
LSS394540	Polyester (Loops) - LRG - 200kg
LSS394550	Polyester (Loops) - XL - 300kg

## Disposable Slings

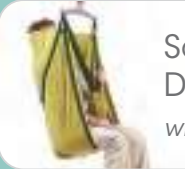

**Solo Highback Disposable Sling with Head Support**

Code	Description
LSS394740	Polyester (Loops) - MED Slim - 200kg
LSS394750	Polyester (Loops) - MED - 200kg
LSS394760	Polyester (Loops) - LRG - 200kg
LSS394770	Polyester (Loops) - XL - 500kg

## Slings for Standing & Mobility

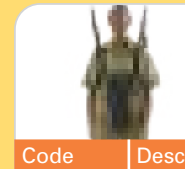

**LiftPants Gait Training Sling**

Code	Description
LSS394340	Mesh (Loops) - SML - 200kg
LSS394350	Mesh (Loops) - MED - 200kg
LSS394360	Mesh (Loops) - LRG - 300kg
LSS394370	Mesh (Loops) - XL - 500kg
LSS394380	Mesh (Loops) - XXL - 500kg
LSS394390	Mesh (Loops) - XXXL - 500kg

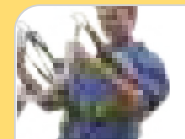

**SupportVest Standing Sling**

Code	Description
LSS394120	Polyester (Loops) - SML - 200kg
LSS394130	Polyester (Loops) - MED - 200kg
LSS394140	Polyester (Loops) - LRG - 200kg
LSS394150	Polyester (Loops) - XL - 200kg

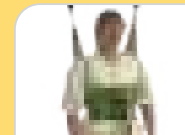

**MasterVest Gait Training Sling**

Code	Description
LSS394260	Polyester (Loops) - SML - 200kg
LSS394270	Polyester (Loops) - MED - 200kg
LSS394280	Polyester (Loops) - LRG - 200kg
LSS394290	Polyester (Loops) - XL - 200kg
LSS394300	Polyester (Loops) - XXL - 200kg
LSS394310	Leg Harness (optional) - SML
LSS394320	Leg Harness (optional) - M/L
LSS394330	Leg Harness (optional) - XL/XXL

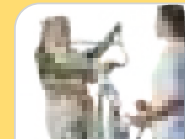

**ComfortVest Standing Sling**

Code	Description
LSS394180	Polyester (Loops) - SML - 200kg
LSS394190	Polyester (Loops) - MED - 200kg
LSS394200	Polyester (Loops) - LRG - 200kg
LSS394210	Polyester (Loops) - XL - 200kg



**SafetyVest Standing Sling**

Code	Description
LSS394160	Polyester (Loops) - MED - 200kg
LSS394170	Polyester (Loops) - LRG - 200kg



## Aspire A205 Aluminium Lifter



- Compact yet versatile mobile patient lifter ideal for high-use facility environments
- Ergonomic handset - Linak technology fits neatly in the hand with an intuitive control panel
- Powered leg function - Opens and closes the legs for lifting stability or accessibility
- High quality castors - 2x 75mm front castors, 2x 100mm rear locking castors
- Quick Release Yoke with Safety Clips - One touch release and attach mechanism. Padded yoke for added patient safety
- Safety stop button - Emergency stop button, emergency lowering and anti-entrapment technology



Code	Description	Overall Height	Overall Length	Overall Width	Lifter Weight
LSS390610	A205 Aluminium Lifter	2045 mm	1135 mm	620mm - 1095 mm	38.1 kg



## Aspire A320 Aluminium Bariatric Lifter



- Heavy duty yet maneuverable bariatric patient lifter ideal for the most demanding clinical environments.
- Ergonomic handles & support arms - provide multiple grip points. Folding support arms assist with stability or mobility
- Safety stop button - emergency stop button, emergency lowering and anti-entrapment technology
- Ergonomic handset - Linak technology fits neatly in the hand with an intuitive control panel
- Powered leg function - opens and closes the legs for lifting stability or accessibility
- Quick release 4 point yoke - one touch release and attach mechanism
- High quality castors - 2x 100mm front castors, 2x 125mm rear locking castors



Code	Description	Overall Height	Overall Length	Overall Width	Lifter Weight
LSS390630	A320 Aluminium Bariatric Lifter	2165 mm	1505 mm	765 mm - 1190 mm	63 kg



### Aspire Pivot Frame

Code	Description
LSS390665	Powered Pivot Frame
LSS390670	Manual Pivot Frame



### Aspire In-Line Weigh Scale

Code	Description
LSS390680	In-Line Weigh Scale



### Aspire Non-Slip One Way Slide

Code	Description
TSE673050	Non-Slip One Way Slide



### Aspire Evacuation Sheet

Code	Description
TSE672526	Evacuation Sheet



### Aspire Slide Sheet

Code	Description
TSE673070	Slide Sheet - Small
TSE673080	Slide Sheet - Large



### Aspire Foot Operated One Way Slide

Code	Description
TSE673052	Foot Operated One Way Slide



### Aspire Positioning Slide - Foot Operated

Code	Description
TSE673054	Positioning Slide - Foot Operated



### Aspire Swivel Cushion

Code	Description
TSE673056	Swivel Cushion

For any Aspire Lifters & Slings, please visit page 186

For any Other Manual Handling Products, please visit page 217





**General Purpose Slings**



**Aspire Deluxe General Purpose Sling**  
*with Head Support*

Code	Description
LSS390900	Polyester (Clips) - SML - 200kg
LSS390905	Polyester (Clips) - MED - 200kg
LSS390910	Polyester (Clips) - LRG - 300kg
LSS390915	Polyester (Clips) - XL - 300kg
LSS390740	Polyester (Loops) - SML - 200kg
LSS390745	Polyester (Loops) - MED - 200kg
LSS390750	Polyester (Loops) - LRG - 300kg
LSS390755	Polyester (Loops) - XL - 300kg
LSS390751	Polyester (Loops) - XXL - 300kg
LSS390752	Polyester (Loops) - XXXL - 300kg
LSS390916	Mesh (Clips) - SML - 200kg
LSS390917	Mesh (Clips) - MED - 200kg
LSS390918	Mesh (Clips) - LRG - 300kg
LSS390919	Mesh (Clips) - XL - 300kg
LSS390756	Mesh (Loops) - SML - 200kg
LSS390757	Mesh (Loops) - MED - 200kg
LSS390758	Mesh (Loops) - LRG - 300kg
LSS390759	Mesh (Loops) - XL - 300kg
LSS3907591	Mesh (Loops) - XXL - 300kg
LSS3907592	Mesh (Loops) - XXXL - 300kg



**Aspire Deluxe General Purpose Sling**

Code	Description
LSS390700	Polyester (Loops) - SML - 200kg
LSS390705	Polyester (Loops) - MED - 200kg
LSS390710	Polyester (Loops) - LRG - 300kg
LSS390715	Polyester (Loops) - XL - 300kg
LSS390716	Mesh (Loops) - SML - 200kg
LSS390717	Mesh (Loops) - MED - 200kg
LSS390718	Mesh (Loops) - LRG - 300kg
LSS390719	Mesh (Loops) - XL - 300kg

**Low Friction Slings**



**Aspire Deluxe Low Friction Parasilk Sling**

Code	Description
LSS390880	Parasilk (Loops) - SML - 200kg
LSS390885	Parasilk (Loops) - MED - 200kg
LSS390890	Parasilk (Loops) - LRG - 300kg
LSS390885	Parasilk (Loops) - XL - 300kg
LSS390960	Parasilk (Clips) - SML - 200kg
LSS390965	Parasilk (Clips) - MED - 200kg
LSS390970	Parasilk (Clips) - LRG - 300kg
LSS390975	Parasilk (Clips) - XL - 300kg

**Hammock Slings**



**Aspire Deluxe Hammock Sling**  
*with Head Support*

Code	Description
LSS390800	Supersoft (Loops) - SML - 200kg
LSS390805	Supersoft (Loops) - MED - 200kg
LSS390810	Supersoft (Loops) - LRG - 300kg
LSS390815	Supersoft (Loops) - XL - 300kg
LSS390860	Mesh (Loops) - SML - 200kg
LSS390865	Mesh (Loops) - MED - 200kg
LSS390870	Mesh (Loops) - LRG - 300kg
LSS390875	Mesh (Loops) - XL - 300kg

**Hygiene Slings**



**Aspire Deluxe Hygiene Access Sling**  
*with Head Support*

Code	Description
LSS390780	Polyester (Loops) - SML - 200kg
LSS390785	Polyester (Loops) - MED - 200kg
LSS390790	Polyester (Loops) - LRG - 300kg
LSS390795	Polyester (Loops) - XL - 300kg
LSS390940	Polyester (Clips) - SML - 200kg
LSS390945	Polyester (Clips) - MED - 200kg
LSS390950	Polyester (Clips) - LRG - 300kg
LSS390955	Polyester (Clips) - XL - 300kg



**Aspire Deluxe Hygiene Access Sling**

Code	Description
LSS390760	Polyester (Loops) - SML - 200kg
LSS390765	Polyester (Loops) - MED - 200kg
LSS390770	Polyester (Loops) - LRG - 300kg
LSS390775	Polyester (Loops) - XL - 200kg
LSS390776	Polyester (Loops) - XXL - 200kg
LSS390777	Polyester (Loops) - XXXL - 300kg
LSS390950	Polyester (Clips) - LRG - 300kg
LSS390955	Polyester (Clips) - XL - 300kg

**Standing Slings**

**Aspire Deluxe Standing Sling**

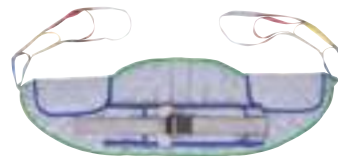

Code	Description
LSS390720	Polyester (Loops) - SML - 200kg
LSS390725	Polyester (Loops) - MED - 200kg
LSS390730	Polyester (Loops) - LRG - 300kg
LSS390735	Polyester (Loops) - XL - 300kg
LSS390736	Polyester (Loops) - XXL - 300kg
LSS390737	Polyester (Loops) - XXXL - 300kg
LSS390920	Polyester (Clips) - SML - 200kg
LSS390925	Polyester (Clips) - MED - 200kg
LSS390930	Polyester (Clips) - LRG - 300kg
LSS390935	Polyester (Clips) - XL - 300kg



For safe, secure and correct sling application and use, please see our **Sling Fitting & Safe Use Guide**



For further details on the Aspire Lifters & Slings, please visit page 186



# Patient Handling - Ceiling Hoists



For NDIS Item Code, refer to page: 508

Exclusive to:



For more information, please visit our Hospital Equipment Range Catalogue

PRISM MEDICAL

## P200 Portable Ceiling Hoist



- With its unique innovative design, the P200 is one of the lightest portable hoists on the market, yet it is capable of lifting up to 200kg
- Suitable for use with fixed ceiling tracks or mobile gantry systems
- The design and features make it perfect for use in community or nursing environments
- Quick Release System (QRS) allows for the P200 to be safely and easily attached or removed from the gantry or track system with an easy reacher

- Pneumatic handset is ideal for use in wet environments
- Emergency lowering allows for the safe lowering of the in emergency situations
- Client safety is assured with locking latches to secure slings in place for all lifts
- Room to Room transfer allows patients to be transferred without the need to be disconnected from the hoist



Code	Description	Height Range	Weight
LIC350120	Manual Traverse	Up to 2070 mm	4.8 kg
LIC350110	Manual Traverse & Quick Release System	Up to 2070 mm	4.8 kg
LIC354170	Quick Release System reacher bar <i>(sold as optional accessory)</i>		

PRISM MEDICAL

## CP200 Fixed or Portable Ceiling Hoist



- Hoist can be reversed to act as a portable or fixed unit providing flexibility of use
- Slimline, low profile, padded carry bar that has six loop attachments as standard (four-point hook optional). Different width carry bars also available
- Low profile hoist unit is unobtrusive and provides greater lifting height
- All lifting and traversing operations have soft start/stop to ensure smooth transfers for the patient
- A host of safety features
- Smooth running tape with large lifting range
- State of the art display with lift counter

- Fire retardant cover completely encapsulates hoist
- Neat in track transformer, IP 67 rated
- Ergonomically designed handset with hold to run clearly marked buttons and directional arrows requires minimum pressure to operate. Pneumatically controlled, making it safe for use in wet conditions
- Coloured direction indicators on hoist unit match hand control to ensure correct operation first time
- Emergency stop and manual emergency window



Code	Description	Height Range	Weight
LIC350105	CP200 Portable Ceiling Hoist	Up to 1960 mm	3.8 kg

### DVA Contact Details

P 1300 888 052 | F 1300 787 052 | E [dva@aidacare.com.au](mailto:dva@aidacare.com.au)



For NDIS Item Code, refer to page: 508





**PRISM MEDICAL**



## Transactive Xtra Fixed Ceiling Hoist

- Digital display screen provides essential information for the user and caregiver
- Return to Charge (RTC) option automatically returns the hoist to its charger when required
- Manual option allows for hoist to continue to be used during a power outage
- Low profile hoist unit is unobtrusive and provides greater lifting height
- Pneumatic handset is ideal for use in wet environments
- Emergency Lowering allows for the safe lowering in emergency situations
- Client safety is assured with locking latches to secure slings in place for all lifts
- Smooth lifting/running tape with large lifting range
- Available in manual or powered traverse options



Code	Description	Height Range	Weight
LIC350130	Transactive Xtra Ceiling Hoist - Manual 130 kg	Up to 2080 mm	9.7 kg
LIC350150	Transactive Xtra Ceiling Hoist - Manual 160 kg	Up to 2080 mm	9.7 kg
LIC350170	Transactive Xtra Ceiling Hoist - Manual 200 kg	Up to 2080 mm	9.7 kg
LIC350200	Transactive Xtra Ceiling Hoist - Manual 270 kg	Up to 2080 mm	9.7 kg
LIC350220	Transactive Xtra Ceiling Hoist - Manual Curtain Jumper - 270 kg	Up to 2080 mm	9.7 kg
LIC350140	Transactive Xtra Ceiling Hoist - Powered 130 kg	Up to 2080 mm	10.4 kg
LIC350160	Transactive Xtra Ceiling Hoist - Powered 160 kg	Up to 2080 mm	10.4 kg
LIC350180	Transactive Xtra Ceiling Hoist - Powered 200 kg	Up to 2080 mm	10.4 kg
LIC350190	Transactive Xtra Ceiling Hoist - Powered RTC 200 kg	Up to 2080 mm	10.4 kg
LIC350210	Transactive Xtra Ceiling Hoist - Powered 270 kg	Up to 2080 mm	10.4 kg
LIC350240	Transactive Xtra Ceiling Hoist - Powered RTC 270 kg	Up to 2080 mm	10.4 kg
LIC350230	Transactive Xtra Ceiling Hoist - Powered Curtain Jumper 270 kg	Up to 2080 mm	10.4 kg



## C380 Bariatric Fixed Ceiling Hoist

- Specifically designed to lift clients that exceed a standard hoist's maximum weight capacity
- As the strongest Ceiling Track Hoist in its class, the C380 safely transfers bariatric clients with respect and dignity
- Low profile hoist unit is unobtrusive and provides greater lifting height
- Digital display screen provides essential information for the user and caregiver
- Return to Charge (RTC) option automatically returns the hoist to its charger when required
- Pneumatic handset is ideal for use in wet environments
- Emergency Lowering allows for the safe lowering of the in emergency situations
- Client safety is assured with locking latches to secure slings in place for all lifts
- Smooth lifting/running tape with large lifting range
- Available in manual or powered traverse options



Code	Description	Height Range	Weight
LIC350250	C380 Bariatric Fixed Ceiling Hoist - Manual Traverse	Up to 2080 mm	10.4 kg
LIC350260	C380 Bariatric Fixed Ceiling Hoist - Powered Traverse	Up to 2080 mm	10.4 kg
LIC350270	C380 Bariatric Fixed Ceiling Hoist - Powered Traverse & RTC	Up to 2080 mm	10.4 kg



## LikoGuard L/XL Fixed ceiling Hoist

- Portable ceiling hoist that can also be used for room-to-room patient transfers
- Can be used to transfer a patient in a sitting position, easily moving from one rail system to another with the use of a transfer strap
- Portability makes it an excellent and economical solution for nursing home and hospital care situations where lifting needs are temporary
- Can be easily attached or removed with no tools and minimum effort from ceiling rails to facilitate convenient transport between rooms
- Quick sling bar change thanks to Q-Link and Quick-Release Hook (QRH)
- Can be mounted two ways for ease of use



Code	Description	Height Range	Weight
LIC359300	LikoGuard - Large - 272 kg	Up to 2300 mm	14 kg
LIC359310	LikoGuard - X-Large - 363 kg	Up to 2300 mm	14 kg



## Multirall 200 Portable Ceiling Hoist



- The Multirall 200 hoist is a portable ceiling hoist that can also be used for room-to-room patient transfers
- Can be used to transfer a patient between rooms in a sitting position, easily moving from one rail system to another with the use of a transfer strap
- It's portability makes it an excellent and economical solution for nursing home and hospital care situations where lifting needs are temporary
- Can be easily attached or removed with no tools and minimum effort from ceiling rails to facilitate convenient transport between rooms
- Quick sling bar change thanks to Q-Link and Quick-Release Hook (QRH)
- Can be mounted two ways for ease of use



Code	Description	Height Range	Weight
LIC359100	Multirall 200 Portable Ceiling Hoist	Up to 1600 mm	8.7 kg



## Likorall 200 Fixed Ceiling Hoist



- The Likorall 200 is an economical fixed ceiling hoist needed to manage everyday lifting situations
- The patented safety drum with speed limiter facilitates electrical emergency lowering
- Ideal for floor lifts in most environments
- Can be equipped with a special carriage for planned transfers between different rooms
- Quick sling bar change thanks to Q-Link and Quick-Release Hook (QRH)
- Ergonomically designed hand control
- Simple wall charging via hand control



Code	Description	Height Range	Weight
LIC359490	Likorall 200 Fixed Ceiling Hoist	Up to 1800 mm	8.7 kg



## Likorall 242 Fixed Ceiling Hoist



- The Likorall 242 ceiling hoist is designed to meet demanding lifting requirements
- The system is an ideal choice for those who want to move the lift motor along a track electronically with a transfer motor, or to control the system with a wireless hand control option
- The patented safety drum with speed limiter facilitates electrical emergency lowering
- Can be equipped with a special carriage for planned transfers between different rooms
- Wireless hand control
- Quick sling bar change thanks to Q-Link and Quick-Release Hook (QRH)
- Simple wall charging via hand control or in rail charging



Code	Description	Height Range	Weight
LIC359535	Likorall 242 - Manual	Up to 2000 mm	8.7 kg
LIC359500	Likorall 242 - Powered Room to Room	Up to 2000 mm	8.7 kg
LIC359510	Likorall 242 - Manual Room to Room	Up to 2000 mm	8.7 kg



## Likorall 250 Fixed Ceiling Hoist



- The Likorall 250 ceiling hoist is designed to meet demanding lifting requirements
- The system is an ideal choice for those who want to move the lift motor along a track electronically with a transfer motor, or to control the system with a wireless hand control option
- The patented safety drum with speed limiter facilitates electrical emergency lowering
- Can be equipped with a special carriage for planned transfers between different rooms
- Wireless hand control
- Quick sling bar change thanks to Q-Link and Quick-Release Hook (QRH)
- Simple wall charging via hand control or in rail charging

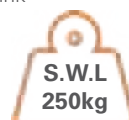

Code	Description	Height Range	Weight
LIC359530	Likorall 250 - Manual	Up to 1800 mm	8.7 kg
LIC359520	Likorall 250 - Powered Room to Room	Up to 1800 mm	8.7 kg

For any Liko Lifter & Sling Accessories, please visit page 196



# Ward Carts



For NDIS Item Code, refer to page: 508



For more information, please visit our [Hospital Equipment Range Catalogue](#)



## Ward Carts



Code	Description	Total Length	Total Width	Total Height	Warranty
1	WAT900705 Treatment Cart - PC Steel - Blue - 1 Drawer	650 mm	480 mm	980 mm	3 Years
2	WAT900730 Dressing Cart - PC Steel - Blue - 2 Drawers	650 mm	480 mm	980 mm	3 Years
3	WAT900700 Medicine Cart - PC Steel - 3 Drawers + 1 Dump Drawer	650 mm	480 mm	980 mm	3 Years
4	WAT900735 Emergency Cart - PC Steel - Red - 5 Drawers	650 mm	480 mm	980 mm	3 Years
5	WAT900695 Anaesthesia Cart - PC Steel - Blue - 2 Drawers + 1 Cupboard	650 mm	480 mm	980 mm	3 Years
6	WAT900720 Infusion Cart - Red - 1 Drawer	650 mm	480 mm	980 mm	3 Years
7	WAT900725 Airway Cart - PC Steel - Red - 6 Drawers	770 mm	480 mm	1070 mm	3 Years
8	WAT900740 Medical Records Cart - PC Steel - Blue - No Drawers	650 mm	480 mm	900 mm	3 Years
8	WAT900745 Medical Records Cart - PC Steel - Blue - 1 Drawer	650 mm	480 mm	900 mm	3 Years

### General Enquiries

P 1300 133 120 | E [sales@aidacare.com.au](mailto:sales@aidacare.com.au) | W [www.aidacare.com.au](http://www.aidacare.com.au)



## Cart Accessories



Code	Description
1	GSP390740 Braked Castors
2	GSP390715 Cardiac CPR Board
3	GSP390725 External Power Holder & Plug Board
4	GSP390700 Defibrillator Shelf
5	GSP390705 Extension Table
6	GSP390750 ABS Divider
7	GSP390755 Luxurious Push Handle
8	GSP390745 Non Slip Mat
9	GSP390720 Waste Bin
10	GSP390735 S/Steel Wire Basket
11	GSP390760 Soft Closing Drawers
12	GSP390710 S/Steel IV Pole

## eCart Range



Code	Description	Total Height	Total Width	Total Length	Warranty
1	WAT901100 Economy Cart - 2 Drawer + Fixed Push Handle (Webster)	1075 mm	760 mm	520 mm	5 Years
2	WAT901110 Economy Cart - 3 Drawer + Dividers (12) + Fixed Push Handle	1075 mm	760 mm	520 mm	5 Years
3	WAT901120 Medication Cart - 3 Drawer (Webster)	1045 mm	760 mm	520 mm	5 Years
4	WAT901130 Medication Cart - 4 Drawer + Dividers (12)	1045 mm	760 mm	520 mm	5 Years
5	WAT901140 Medication Cart - 5 Drawer + Dividers (12)	1045 mm	760 mm	520 mm	5 Years
6	WAT901150 Med/Theatre Wide Cart - 4 Drawer + Dividers (12 & 14)	1065 mm	870 mm	570 mm	5 Years
7	WAT901160 Med/Theatre Wide Cart - 5 Drawer + Dividers (12 & 14)	1065 mm	870 mm	570 mm	5 Years
8	WAT901170 Anaesthetic Cart (Blue) - 5 Drawer + S/Steel Top + Guardrail + Tilt Containers (17)	1580 mm	760 mm	545 mm	5 Years
9	WAT901180 Emergency Cart (Red) - 5 Drawer + Oxy Carrier + IV Pole + Cardio Board	1075 mm	760 mm	520 mm	5 Years
10	WAT901210 Sachet Cart - 6 Drawer + Dividers (10)	1045 mm	760 mm	520 mm	5 Years
11	WAT901220 Procedure Cart (Grey) - 5 Drawer + IV Pole + Storage Basket	1045 mm	760 mm	520 mm	5 Years
12	WAT901230 Isolation Cart (Yellow) - 4 Drawer + Glove Dispenser Holder + Dividers (12)	1045 mm	760 mm	520 mm	5 Years

### DVA Contact Details

P 1300 888 052 | F 1300 787 052 | E [dva@aidacare.com.au](mailto:dva@aidacare.com.au)



For NDIS Item Code, refer to page: 508



## eCart Accessories

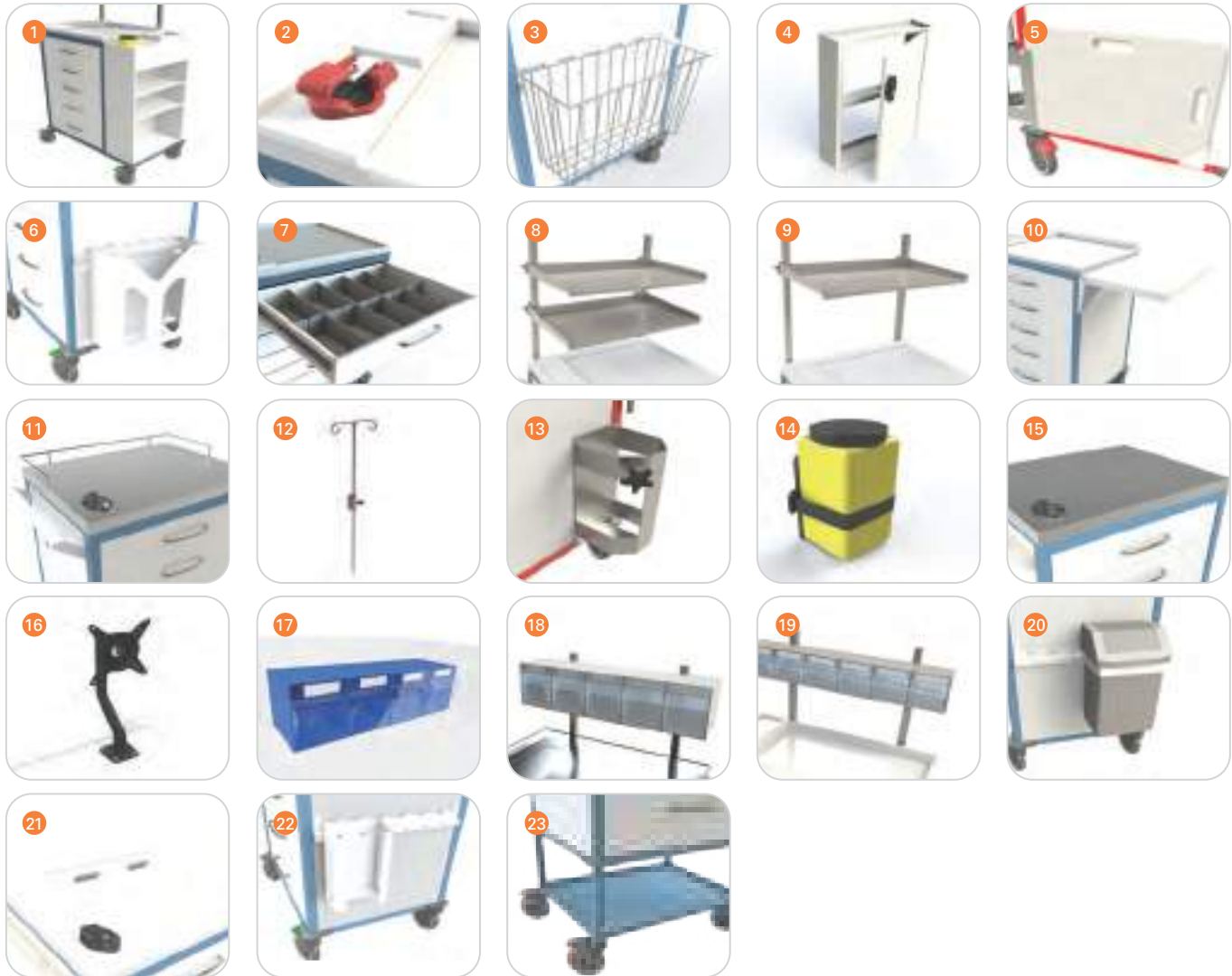

Code	Description
1	WAT902100 Accessory Module
2	WAT902105 Anti-Tamper Lock
3	WAT902110 Basket
4	WAT902120 Bottle Cabinet - Fitted with Key Lock
5	WAT902130 Cardiac Board
6	WAT902140 Chart Holder
7	WAT902150 Dividers (1 x Set) (4 x 3 = 12)
	WAT902160 Divider Name Tabs
	WAT902170 Defibrillator Arm
8	WAT902220 Equipment Shelf - Double
9	WAT902230 Equipment Shelf - Single
10	WAT902240 Folding Side Shelf
	WAT902440 Drive Unit
11	WAT902250 Guard Rail
12	WAT902260 Intravenous Pole with Corner Bracket

Code	Description
13	WAT902280 Oxygen Bottle Carrier
14	WAT902300 Sharps Holder
15	WAT902310 Stainless Steel Top
16	WAT902320 Tablet Arm
17	WAT902330 Tilt Container - 4
18	WAT902340 Tilt Container - 5
19	WAT902350 Tilt Container - 6
	WAT902360 Tilt Container - 9
	WAT902370 Mount Arms for Tilt Container (Pair)
20	WAT902380 Waste Bin
21	WAT902390 Webster Clips (Pair) to Suit Wire Webster Rack
22	WAT902400 Glove Dispenser
23	WAT901105 Tray

## File Trolley

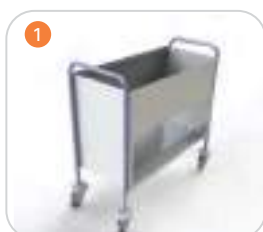

- Diameter 25mm push handle at both ends
- Lightweight
- Swivel wall buffers
- Storage Tray
- Accepts standard suspension files
- 100 mm swivel castors

Code	Description	Total Length	Total Width	Total Height	Warranty
1	WAT900910 File Trolley	950 mm	420 mm	980 mm	5 Years
2	WAT900920 File Trolley Lid - Lockable				5 Years

### General Enquiries

P 1300 133 120 | E sales@aidacare.com.au | W www.aidacare.com.au

# Instrument / Dressing Trolleys



For NDIS Item Code, refer to page: 508

For more information, please visit our Hospital Equipment Range Catalogue

## Powder Coated Instrument / Dressing Trolley



- Soft magnetic closing drawers
- Smooth running castors
- Lockable front wheels
- 125mm deep drawers
- Top and bottom rails on 3 sides
- Outstanding finish

3 Year Warranty

	Code	Description	Total Length	Total Width	Total Height
1	WAT900625	Instrument Trolley - PC Steel - 2 Shelves	500 mm	500 mm	950 mm
2	WAT900685	Instrument Trolley - PC Steel - 1 Drawer	500 mm	500 mm	950 mm
3	WAT900690	Instrument Trolley - PC Steel - 2 Drawers	500 mm	500 mm	950 mm

## Instrument Trolley (Thermoplastic)

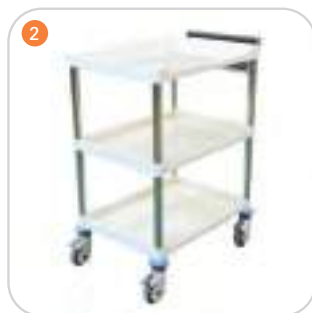

- Push handle
- Strong polymer shelves
- Easy to clean

3 Year Warranty

	Code	Description	Total Length	Total Width	Total Height
1	WAT900615	Instrument Trolley - 2 Thermoplastic Shelves	650 mm	480 mm	900 mm
2	WAT900620	Instrument Trolley - 3 Thermoplastic Shelves	650 mm	480 mm	900 mm

### DVA Contact Details

P 1300 888 052 | F 1300 787 052 | E [dva@aidacare.com.au](mailto:dva@aidacare.com.au)



For NDIS Item Code, refer to page: 508





## Instrument/Dressing Trolley (Stainless Steel)

- Stainless steel construction
- Total lock castors on front wheels
- Guard rail on 3 sides
- Drawers fitted with high quality runners with soft close magnetic latch
- 140mm deep drawers



Code	Description	Total Length	Total Width	Total Height	Warranty
WAT900800	Instrument Trolley - Square Frame	500 mm	500 mm	1040 mm	5 Years
1 WAT900810	Instrument Trolley - Square Frame + 1 Drawer	500 mm	500 mm	1040 mm	5 Years
2 WAT900820	Instrument Trolley - Square Frame + 2 Drawers	500 mm	500 mm	1040 mm	5 Years
3 WAT900830	Instrument Trolley - Square Frame + 4 Drawers	500 mm	500 mm	1040 mm	5 Years
4 WAT900840	Dressing Trolley - Square Frame	800 mm	500 mm	1040 mm	5 Years
5 WAT900850	Dressing Trolley - Square Frame + 1 Drawer	800 mm	500 mm	1040 mm	5 Years
6 WAT900860	Dressing Trolley - Square Frame + 2 Drawers (Full Length)	800 mm	500 mm	1040 mm	5 Years



## Instrument/Dressing Trolley - Flat Top (Stainless Steel)

- Stainless steel construction
- Flat top fully welded
- 100mm total lock castors

Code	Description	Total Length	Total Width	Total Height	Warranty
WAT900880	Instrument Trolley - Flat Top 500 x 500 x 950	500 mm	500 mm	950 mm	5 Years
WAT900890	Instrument Trolley - Flat Top 500 x 800 x 950	800 mm	500 mm	950 mm	5 Years
WAT900900	Instrument Trolley - Flat Top 500 x 1000 x 950	1000 mm	500 mm	950 mm	5 Years



For Kitchen Trolleys  
Refer to Page 182

# Other Trolleys & Carts



For NDIS Item Code, refer to page: 508

For more information, please visit our Hospital Equipment Range Catalogue



Linen Skip - No Lid

Code	Description
LAC500800	Single
LAC500810	Double
LAC500820	Triple



Linen Skip - Foot Operated Lid

Code	Description
LAC500860	Single
LAC500870	Double
LAC500880	Triple



Economy Linen Skip - No Lid

Code	Description
LAC500830	Single
LAC500840	Double
LAC500850	Triple



Economy Linen Skip - Foot Operated Lid

Code	Description
LAC500890	Single
LAC500900	Double
LAC500910	Triple



Economy Clean Linen Trolley

Code	Description
LAC353640	Small - Open
LAC353610	Large - Open
LAC353620	Small - Closed
LAC353590	Large - Closed



Wet & Dry Linen Trolley

Code	Description
LAC353380	Small
LAC354190	Medium
LAC354210	Large



Moist Linen Trolley

Code	Description
LAC354025	Small
LAC354030	Large



Deluxe Clean Linen Trolley

Code	Description
LAC353560	Deluxe Clean Linen Trolley



Flow Chart Trolley

Code	Description
WAT900940	Flow Chart Trolley

## DVA Contact Details

P 1300 888 052 | F 1300 787 052 | E [dva@aidacare.com.au](mailto:dva@aidacare.com.au)



For NDIS Item Code, refer to page: 508



**Linen Folding Table**

Code	Description
LAC501000	Fixed Height
LAC501010	Electric



**Arm Operating Table**

Code	Description
WAT820190	Arm Operating Table



**Garment Dispensing Trolley**

Code	Description
LAC353650	16 Trays
LAC353660	20 Trays
LAC353680	30 Trays
LAC353470	Tray



**Food Tray Dispensing Trolley**

Code	Description
WAT823500	8 Tray
WAT823600	16 Tray
WAT824000	24 Tray



**Food Tray Clearing Trolley**

Code	Description
WAT824400	2 Shelf
WAT824600	3 Shelf
WAT824700	Food Tray - 450 x 350 mm

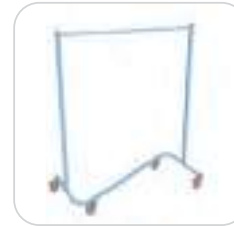

**Garment Rack**

Code	Description
LAC353462	Garment Rack - Z Base



**Stock Trolley**

Code	Description
WAT825510	Stock Trolley



**File Trolley**

Code	Description
WAT900910	File Trolley



**Utility Cart**

Code	Description
LAC353011	Black
LAC353010	White



**Cleaning Cart**

Code	Description
LAC353012	Cleaning Cart
LAC353013	Locking Cabinet

For Detailed Trolley Range See Page 177

# Weigh Chairs & Scales



For NDIS Item Code, refer to page: 508

Brochures also available. Please contact us for a copy.

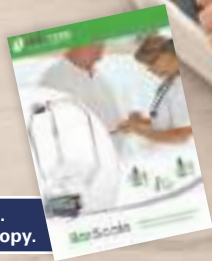

## Aidacare Bariscale



- Australian made portable bariatric scale with a 400 kg capacity
- Stainless steel handrails for easy cleaning and sanitising
- Powder coated weigh pan for durability
- Open front design and robust handrails allow for the largest patients or residents to safely access the platform
- Base plate has been designed to minimise tripping hazards and increased accessibility with it's super low clearance (38mm) and tapered sides
- Advanced digital display with battery and power pack
- Nylon castors for easy transportation
- 4x high quality industrial load cells provide precision weight readings up to 400kg



Digital



Access



Portable



Accurate

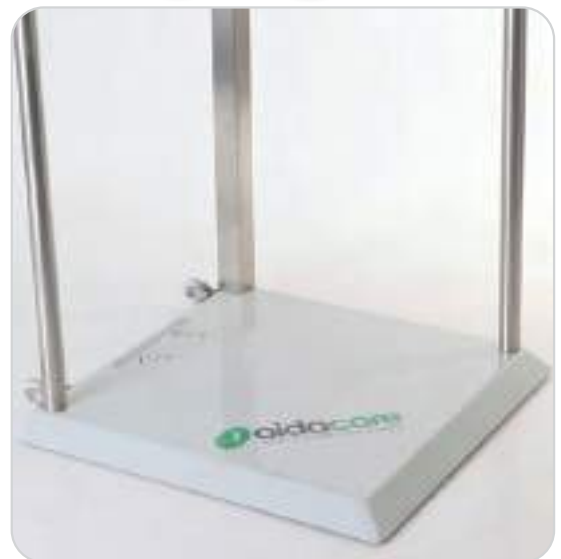

Stability

Code	Description	Width	Depth	Height	Base Height	S.W.L
LSS362005	Aidacare Bariscale	660 mm	660 mm	900 mm	38 mm	400 kg

### DVA Contact Details

P 1300 888 052 | F 1300 787 052 | E [dva@aidacare.com.au](mailto:dva@aidacare.com.au)



For NDIS Item Code, refer to page: 508







TOP SELLER

## Premium Digital Weigh Chair

- Ideal for accurate and convenient patient weighing
- Easy to read weight display
- Swivel wheels with safety brakes plus built in footrests
- Easy to clean surfaces essential in health care environments
- 100 hours use from regular batteries



Code	Description	Width	Depth	Height	S.W.L	Warranty
LSS377700	Premium Digital Weigh Chair	680 mm	635 mm	880 mm	150 kg	1 Year



## Economy Digital Weigh Chair

- Lift away armrests and non-slip foot support
- Push handles and 4" castors for portability
- Safety stops on rear castors for parking without rolling
- Changeable plastic seat for easy cleaning
- Internal rechargeable battery



Code	Description	Width	Depth	Height	S.W.L	Warranty
LSS377704	Economy Digital Weigh Chair	665 mm	840 mm	940 mm	250 kg	1 Year



## Healthweigh Digital Weigh Chair

- Measure the weight of residents in a safe and comfortable manner
- Ergonomically contoured seat
- Folding armrests
- Accurate weight measurements for carers
- Comfort and ease of transfers
- Large LCD screen



Code	Description	Width	Height	S.W.L	Warranty
LSS377706	Healthweigh Digital Weigh Chair	630 mm	965 mm	300 kg	2 Years



## Wheelchair Scale Digital

- Wheelchair Scale with low profile ramp design
- Powder coated steel construction
- Non-slip surface
- Portable



Code	Description	Width	Depth	S.W.L	Warranty
LSS362000	Wheelchair Scale Digital	1100 mm	1300 mm	300 kg	1 Year

## Medication Fridges & Drug Safes

### Drug Safes



WAT763100 - 1 Shelf Left Hinge  
WAT763101 - 1 Shelf Right Hinge  
WAT770900 - 2 Shelf Left Hinge  
WAT770901 - 2 Shelf Right Hinge

### Medication Fridges



### Medication Fridges - Glass



### Breast Milk Fridges



Contact Us for the Full Range

# General Ward Equipment



For NDIS Item Code, refer to page: 508



## Stethoscope Luxury Dual Head

- Well designed economical stethoscope
- Light weight aluminum reversible head & chest piece
- Non chill ring for patient comfort

Code	Description	Warranty
GMD300100	Stethoscope Luxury Dual Head - Black	1 Year
GMD300110	Stethoscope Luxury Dual Head - Magenta	1 Year
GMD300120	Stethoscope Luxury Dual Head - Navy Blue	1 Year



## Stethoscope Liberty Classic

- Classic stainless steel stethoscope
- Stainless steel chest piece
- Double inner spring binaural
- Non chill ring and diaphragm-retaining ring for patient comfort

Code	Description	Warranty
GMD300200	Stethoscope Liberty Classic - Black	1 Year
GMD300210	Stethoscope Liberty Classic - Magenta	1 Year
GMD300220	Stethoscope Liberty Classic - Navy Blue	1 Year



## Sphygmomanometer Basic

- Palm style sphygmomanometer designed for convenience with left or right handed use
- Large 550mm dial
- Includes adult cuff plus nylon carry case
- Latex free

Code	Description	Warranty	DVA:
GMD300280	Sphygmomanometer Basic Aneroid One Hand	1 Year	AS01



## Sphygmomanometer Aneroid

- Hand held Sphygmomanometer features 300mmHg non stop pin manometer
- Velcro cuff complete with bladder, bulb & valve
- Comes with leatherette zipped case

Code	Description	Warranty	DVA:
GMD300300	Sphygmomanometer Aneroid	1 Year	AS01
GMD300305	Sphygmomanometer Aneroid - Large	1 Year	AS01



## Sphygmomanometer Aneroid Erka Switch

- Hand held Sphygmomanometer features outstanding ergonomic design
- Allows for simple adaption for the right or left handed user
- User friendly valve cap for ease of use
- Latex free

Code	Description	Warranty
GMD300310	Sphygmomanometer Aneroid Erka Switch	1 Year
GMD300315	Sphygmomanometer Erka Switch Cuff & Bladder 1 Tube - Royal Blue	1 Year



## Sphygmomanometer Digital Semi Auto

- Digital Semi Auto measures systolic and diastolic pressure and pulse
- Easy to read digital display
- Automatic deflation plus automatic off
- Self adjusting D - bar cuff for one handed application

Code	Description	Warranty
GMD300320	Sphygmomanometer Digital Semi Auto	1 Year

### DVA Contact Details

P 1300 888 052 | F 1300 787 052 | E [dva@aidacare.com.au](mailto:dva@aidacare.com.au)



For NDIS Item Code, refer to page: 508



## Sphygmomanometer Digital Auto

- Hand held automatic Sphygmomanometer measures systolic and diastolic pressure and pulse
- Features a unique memory of the last 7 readings
- Easy to read digital display



## Blood Pressure Monitor Semi Automatic

- Measures & simultaneously displays Systolic, Diastolic & Pulse
- Semi automatic, one button pressurisation, measurement & exhaust
- Automatic power - off function to preserve battery life

Code	Description	Warranty	DVA:
GMD300330	Sphygmomanometer Digital Auto	1 Year	AS01

Code	Description	DVA:
GMD332025	Blood Pressure Monitor Semi Automatic	AS01



## Pulse Oximeter

- High quality precision manometer designed to fix directly to a wall
- Housing made from high quality ABS in signal white/light grey
- Manometer features a scale inclined by 12°



## Sphygmomanometer Aneroid Erka Vario Wall Model

- High quality precision manometer designed to fix directly to a wall
- Housing made from high quality ABS in signal white/light grey
- Manometer features a scale inclined by 12°

Code	Description	Warranty
GMD332920	Pulse Oximeter - Finger Tip	1 Year
GMD332925	Pulse Oximeter - Hand Held with Alarm	1 Year

Code	Description	Warranty
GMD300380	Sphygmomanometer Aneroid Erka Vario Wall Model	1 Year



## Sphygmomanometer Aneroid Erka Vario Desk Model

- High quality precision manometer designed to sit on a stable, flat surface
- Housing made from high quality ABS in signal white/light grey
- Manometer features a scale inclined by 12°



## Sphygmomanometer Aneroid Erka Vario Trolley Light Weight

- Sold as a kit consisting of mobile trolley with five star base plus quality precision manometer

Code	Description	Warranty
GMD300370	Sphygmomanometer Aneroid Erka Vario Desk Model	1 Year

Code	Description	Warranty
GMD300340	Sphygmomanometer Aneroid Erka Vario Trolley - Light Weight	1 Year
GMD300350	Sphygmomanometer Aneroid Erka Vario Trolley - Medium Weight	1 Year
GMD300360	Sphygmomanometer Aneroid Erka Vario Trolley - Heavy Weight	1 Year



## Sphygmomanometer Aneroid (Trolley / Wall Model)

- Available in trolley or wall model
- Large, easy to read 150mm dial
- Nylon velcro cuff, bladder, bulb and valve included
- Also supplied with nickel plated air release valve plus 8ft of coil tubing



## Thermometer Digital Clinical

- Thermometer is easy to read
- Beeps when ready with auto shut off
- Features memory of the last measured temperature
- 100+ hours of battery life

Code	Description
GMD333530	Sphygmomanometer Aneroid Trolley Model
GMD300375	Sphygmomanometer Aneroid Wall Model

Code	Description	Warranty
GMD300390	Thermometer Digital Clinical	1 Year
GMD300400	Thermometer Digital Clinical Flexible Tip	1 Year
GMD300410	Thermometer Digital Clinical Liberty Rapid Read	1 Year



## Thermometer Digital Ear Tympanic

- Measurement temperature range of 33.5 - 42.0°
- Performance of up to 4000 uses with AAA batteries (not included)

Code	Description	Warranty
GMD300420	Thermometer Digital Ear Tympanic	1 Year
GMD300430	Replacement Disposable Ear Covers	1 Year



## Nurses Pick-Pocket

- The Pick-Pocket increases efficiency, no more running back and forth for scissors or more tape, measures 200mm x 150mm
- Secure zip compartment for your valuables. Also perfect for carrying your mobile phone or PDA
- Pens and scissors can be safely stored in the Pick-Pocket

Code	Description
GMD300550	Nurses Pick-Pocket



## Blood Collection Chair

- Comfortable, soft, supportive foam on seat and armrests
- Extra wide
- Foldable footrest
- 1 Year Warranty

Code	Description	Seat Height	Seat Depth	Seat Width	S.W.L
WAT823000	Blood Collection Chair - Grey	660 mm	650 mm	550 mm	175 kg



## Slim-line X Ray Viewer

- Lightweight and high luminescence LCD X-Ray viewer
- Slim-line modern design
- 100,000 hours working life
- 1 Year Warranty

Code	Description	Length	Width	Height
WAT819700	X - Ray Viewer - Single	470 mm	24 mm	550 mm
WAT819500	X - Ray Viewer - Double	950 mm	24 mm	550 mm
WAT819800	X - Ray Viewer - Triple	1230 mm	41 mm	550 mm
WAT819600	X - Ray Viewer - Quad	1700 mm	41 mm	550 mm



## Folding Screen

- Mobile Folding Screen provides privacy for patients
- Folds flat for easy transportation and storage

Code	Description	Width	Depth	Height	Warranty
WAT825250	Folding Screen - 3 Bay	2300 mm	550 mm	1800 mm	3 Years



## Kidney Dish

- Kidney Dish range is used to hold dressings or instruments
- Available in a number of sizes
- Available in clear plastic disposable or green autoclavable for easy sanitising

Code	Description	Capacity
WAT770400	Kidney Dish Clear Plastic Disposable	700 ml
WAT770500	Kidney Dish Green Autoclavable	200 ml
WAT770600	Kidney Dish Green Autoclavable	600 ml
WAT770700	Kidney Dish Green Autoclavable	800 ml



## Wash Bowl

- Wash bowl is autoclavable for sanitising
- Moulded plastic construction
- Can also be used for bedside commodes

Code	Description	Capacity
WAT769800	Wash Bowl - Green Plastic - 140 x 40 mm Deep	600 ml
WAT770000	Wash Bowl - Green Plastic - 210 x 80 mm Deep	1500 ml
WAT761200	Wash Bowl - Green Plastic - 305 x 90 mm Deep	3500 ml
WAT769600	Wash Bowl - Green Plastic - 345 x 120 mm Deep	5500 ml

## More Bed Pans & Urine Bottles



Aspire Bowl with Handle & Lid  
BTC081610  
(Refer to Page 311)



Bed Pan  
BTT151800  
(Refer to Page 311)



Male Urine Bottles  
BTT145700 - green  
BTT160900 - clear  
(Refer to Page 311)



## Aspire IV Pole

- 4 point IV pole
- Adjustable height pole with soft dampener
- Stable 5 star plastic base

Code	Description	Base Diameter	Height	Warranty
WAT820180	Aspire IV Pole - 5 Star Base	570 mm	1660 - 2900 mm	1 Year



## Aspire Stackable IV Pole

- Stackable design to minimise storage space
- Organised storage system
- One hand height adjustment
- Cast iron base with stainless steel pole for stability, durability and better performance with heavy devices



Code	Description	Base Diameter	Height	Warranty
WAT820185	Aspire IV Pole - 5 Star Base	637 x 518 mm	1354 - 2214 mm	2 Years



## Mobile IV Stand

- 2 point "pig tail" IV bag attachment
- Adjustable pole with pneumatic dampener mechanism to retard adjustment speed
- Stainless steel 25mm diameter upright can accept 1x syringe pump
- Stable 5 star stainless steel base

Code	Description	Base Diameter	Height	Warranty
WAT820110	IV pole - Mobile - 50 mm Blue Rubber Castors	500 mm	1350 - 2250 mm	5 Years
WAT820120	IV pole - Mobile - 75 mm Grey Rubber Castors	500 mm	1350 - 2250 mm	5 Years
WAT820130	IV pole - Mobile - 100 mm Grey Rubber Castors	500 mm	1350 - 2250 mm	5 Years
WAT820140	IV pole - Mobile - 100 mm Grey Castors + Push Ring + 4 Hooks	500 mm	1350 - 2250 mm	5 Years
WAT820170	Push Handle Ring - To Suit IV Pole & Syringe Pump Range			5 Years

Pictured with optional Push Ring Handle



## Mobile IV Stand - Electric

- Electric high/low foot switch operation
- Water rated electrics
- Stainless steel 25mm diameter upright can accept syringe pumps, volumetric, infusion/PLA pumps
- Removable battery pack
- 6 point "pig tail" IV bag
- Stable 5 star stainless steel base

Code	Description	Base Diameter	Height	Warranty
WAT820145	IV pole - Mobile - 5 star base - Electric High Low - (Capacity - 4 x infusion + 6 x 3L bags)	600 mm	1550 - 1950 mm	5 Years



## Mobile IV Stand - Plastic/Poly Base

- Features stable, five star polyurethane base to minimise staff injury and wall or furniture damage
- Adjustable two point 'Pig Tail' IV attachment

Code	Description	Base	Height	DVA:
WAT819200	Mobile IV Stand - Plastic Base	580 mm	1300 - 2200 mm	AT12
WAT819100	Mobile IV Stand - Poly Base	500 mm	1300 - 2200 mm	AT12
WAT820000	IV Pole Hook 4 Prong			
WAT820100	IV Pole PH			



## Syringe Pump Stand

- 4 point "pig tail" IV bag attachment
- Adjustable pole with pneumatic dampener mechanism to retard adjustment speed
- Stainless steel 25mm upright can accept up to 4 syringe pumps / volumatic infusion pumps / PCA pumps
- Push handle
- 4 pin power board AS3760 (earthed)
- Heavy duty orange power cable
- Stable 6 star base (earthed)
- 100mm grey rubber swivel castors

Code	Description	Base Diameter	Height	Warranty
WAT820150	Syringe Pump Stand - Mobile - 6 Star Base + Power Board + Push Handle + 4 Hook	600 mm	1550 - 2000 mm	5 Years
WAT820160	Syringe Pump Stand - Mobile - 6 Star Base + 4 Hook - Economy - No P/board or P/handle	600 mm	1550 - 2000 mm	5 Years



## Mobile Lotion Bowl Stand

- Diameter 300mm bowl location frame
- Stainless steel upright
- Stable 5 point contoured base
- 50 mm grey swivel rubber castors

Code	Description	Total Height	Warranty
WAT900930	Mobile Lotion Bowl Stand	900 mm	5 Years



CONTACT US  
FOR A BROCHURE



# TREATMENT CHAIRS

**Multiline NEXT IT**  
*Infusion Treatment*

**Multiline NEXT DC**  
*Dialysis & Chemotherapy*

**Multiline XXL Bariatric**  
*Bariatric Treatment Chair*





# Hospital Mortuary & Funeral Homes

# Contents

P 370 Funeral Home &  
Mortuary Equipment





# Funeral Home & Mortuary Equipment



## Chapel Trolley

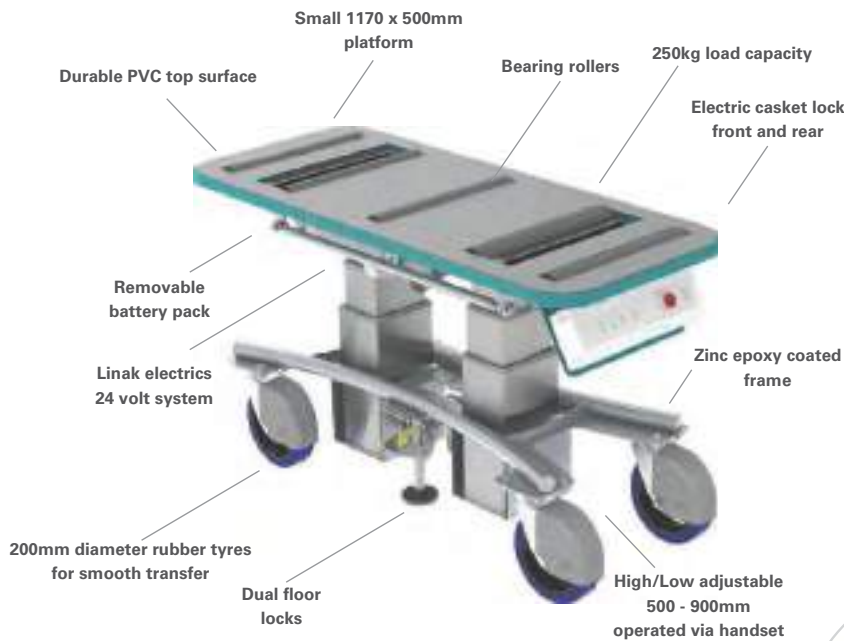

sova lightly in motion



Height Range 500 - 900mm



Chapel Trolley - Fabric Skirt

Colour options available



- Easily transfer coffin without having to manually lift
- High/low operation accommodates any vehicle height
- Electric high/low operation. Optional skirt allows trolley to transform to a chapel stand. Electric casket brake
- Electric casket lock front and rear
- Zinc epoxy coated frame
- Dual floor locks
- 200mm diameter rubber tyres for smooth transfer
- Linak electrics 24 volt system

Code	Description	Length	Width	Height	S.W.L
WAT903260	Chapel Trolley	1200 mm	505 mm	500 - 900 mm	350 kg
WAT903270	Chapel Trolley - Fabric Skirt				

General Enquiries

P 1300 133 120 | E sales@aidacare.com.au | W www.aidacare.com.au



## Aidacare A320 Aluminium Bariatric Lifter



### Ergonomic Handles & Support Arms



Provide multiple grip points. Folding support arms assist with stability or mobility

### Safety Stop Button



Emergency stop button, emergency lowering and anti-entrapment technology

### Powered Leg Function



Opens and closes the legs for lifting stability or accessibility

### Quick Release 4 Point Yoke

One touch release and attach mechanism



### Ergonomic Handset

Linak technology fits neatly in the hand with an intuitive control panel



### High Quality Castors

2 x 100mm front castors  
2 x 125mm rear locking castors



**1**  
Year  
Warranty

Battery

**3**  
Year  
Warranty

Electronics

**5**  
Year  
Warranty

Frame

**S.W.L**  
**320kg**

Code	Description	Overall Height	Overall Length	Overall Width	Lifter Weight
LSS390630	Lifter A320 - Bariatric Lifter - Aluminium	2165 mm	1505 mm	765 mm	63 kg



### Mortuary Trolley - 200kg

- Dual purpose roller design for coffin & body trays
- Handset high/low
- Heavy duty engineered polymer rollers
- Height adjustable push handle
- Electric high/low operation
- Rechargeable battery pack
- Electric body tray & coffin brake



### Mortuary Trolley - 350kg

- Dual purpose roller design for coffin & body trays
- Dual actuators
- Heavy duty engineered polymer rollers
- Ergonomic side push/pull handles
- Electric high/low operation
- Electric coffin/tray brake
- High capacity maintenance free battery pack



Code No.	Description	Length	Width	Height	S.W.L
WAT903230	Mortuary Trolley - 200 kg	2060 mm	640 mm	290 - 1700 mm	200 kg
WAT903235	Mortuary Trolley - Side Loading - 200 kg	2060 mm	640 mm	290 - 1700 mm	200 kg

Code	Description	Length	Width	Height	S.W.L
WAT903240	Mortuary Trolley - 350 kg	2270 mm	750 mm	475 - 1900 mm	350 kg
WAT903245	Mortuary Trolley - Side Loading - 350 kg	2270 mm	750 mm	475 - 1900 mm	350 kg



### Mortuary Trolley - Drive Unit - 350kg

- Dual purpose roller design for coffin & body trays
- Dual actuators
- Heavy duty engineered polymer rollers
- Ergonomic side push/pull handles
- Electric high/low operation
- Electric coffin/tray brake
- High capacity maintenance free battery pack
- Electric drive unit
- Flat free tyres
- Electric safety park brake
- Variable speed controller
- Suspension system for uneven surfaces & superior traction
- Digital volt meter

Code	Description	Length	Width	Height	S.W.L
WAT903250	Mortuary Trolley - Drive Unit - 350 kg	2460 mm	750 mm	475 - 1900 mm	350 kg
WAT903255	Mortuary Trolley - Drive Unit - Side Loading - 350 kg	2460 mm	750 mm	475 - 1900 mm	350 kg

### DVA Contact Details

P 1300 888 052 | F 1300 787 052 | E [dva@aidacare.com.au](mailto:dva@aidacare.com.au)

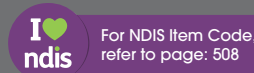



## Mortuary Trolley Turn Table - 200kg

- 90 degree rotatable roller bed for tight spaces
- Dual purpose roller design
- Handset high/low
- Heavy duty engineered polymer rollers
- Height adjustable push handle
- Electric high/low operation
- Electric body tray & coffin brake
- Electric body tray drain angle function



Code	Description	Length	Width	Height	S.W.L
WAT903215	Mortuary Trolley Turn Table	2140 mm	705 mm	450 - 1700 mm	200 kg



## Embalming/Autopsy Trolley - 200kg

- Dual actuators
- 304 stainless steel top section
- Electric tilt function for easy draining
- Drain hole with hose
- Push handles both ends
- Corner buffers
- Electric tilt function for easy drainage
- 4 x buffers on corners



Code	Description	Length	Width	Height	S.W.L
WAT903220	Embalming/Autopsy Trolley	2200 mm	740 mm	615 - 1015 mm	200 kg
WAT903280	Infill panels				



## Concealment Trolley - 250kg

- Linac electrics – 24 volt system
- Hard-wired handset
- High/low adjustable 650 - 1050mm
- Removable battery
- Zinc epoxy coated base frame
- Stainless steel top frame and tray
- 150mm lockable castors
- Gas Strut operated side rails



Code	Description	Length	Width	Height	S.W.L
WAT903210	Concealment Trolley	2055 mm	740 mm	650 - 1050 mm	250 kg



## Mortuary Body Rack 1 Bay - 2 Tier - Mobile

- Open designs allows access for cleaning
- 2 tier modular design (multiple bays can be assembled)
- 100mm total lock castors
- Optimised tier height
- Custom size can be designed
- 200 - 350kg SWL per bay



Code	Description	Length	Width	Height	S.W.L
WAT903171	1 Bay - 2 Tiers - Light	2080 mm	715 mm	1170 mm	200 kg
WAT903170	1 Bay - 2 Tiers - Std	2320 mm	715 mm	1170 mm	300 kg
WAT903172	1 Bay - 2 Tiers - Bariatric	2320 mm	915 mm	1170 mm	350 kg



## Mortuary Body Rack - 1 Bay - 3 Tier

- Open designs allows access for cleaning
- 3 tier modular design (multiple bays can be assembled)
- Adjustable stainless steel feet
- Optimised tier height
- Custom size can be designed
- 200 - 350kg SWL per bay



Code	Description	Length	Width	Height	S.W.L
WAT903174	1 Bay - 3 Tiers - Light	2080 mm	715 mm	1510 mm	200 kg
WAT903173	1 Bay - 3 Tiers - Std	2320 mm	715 mm	1670 mm	300 kg
WAT903177	1 Bay - 3 Tiers - Bariatric	2320 mm	915 mm	1670 mm	350 kg
WAT903176	1 Bay - 3 Tiers - Side Loading - Light	2110 mm	715 mm	1510 mm	200 kg
WAT903175	1 Bay - 3 Tiers - Side Loading - Std	2320 mm	715 mm	1670 mm	300 kg
WAT903178	1 Bay - 3 Tiers - Side Loading - Bariatric	2320 mm	915 mm	1670 mm	350 kg



## Mortuary Body Rack - 2 Bay - 3 Tier

- Open designs allows access for cleaning
- 3 tier modular design (multiple bays can be assembled)
- Adjustable stainless steel feet
- Optimised tier height
- Custom size can be designed
- 200kg SWL per bay



Code	Description	Length	Width	Height	S.W.L
WAT903184	2 Bay - 3 Tiers - Light	2080 mm	1380 mm	1510 mm	200 kg



## Mortuary Body Rack - 2 Bay - 4 Tier

- Open designs allows access for cleaning
- 4 tier modular design (multiple bays can be assembled)
- Adjustable stainless steel feet
- Optimised tier height
- Custom size can be designed
- 200kg SWL per bay



Code	Description	Length	Width	Height	S.W.L
WAT903190	2 Bay - 4 Tiers - Light	2080 mm	1380 mm	1510 mm	200 kg



## Mortuary Body Rack - 1 Bay - 4 Tier

- Open designs allows access for cleaning
- 4 tier modular design (multiple bays can be assembled)
- Adjustable stainless steel feet
- Optimised tier height
- Custom size can be designed
- 200kg SWL per bay



Code	Description	Length	Width	Height	S.W.L
WAT903180	1 Bay - 4 Tiers - Light	2080 mm	715 mm	1760 mm	200 kg



## Mortuary Body Tray - Light - 200kg

- Stainless steel construction
- Push/pull handles both ends
- Angled sides allow for easy side transfer
- Tubular sub-frame
- Angled corners allow for easy cleaning and fluid removal



Code	Description	Length	Width	Height	S.W.L
WAT903151	Mortuary Body Tray - Light - End Loading	1950 mm	600 mm	165 mm	200 kg
WAT903153	Mortuary Body Tray - Light - Side Loading	1950 mm	600 mm	165 mm	200 kg

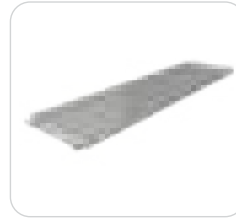

## Mortuary Body Tray - Standard - 300kg

- Stainless steel construction
- Push/pull handles both ends
- Angled sides allow for easy side transfer
- Tubular sub-frame
- Angled corners allow for easy cleaning and fluid removal



Code	Description	Length	Width	Height	S.W.L
WAT903150	Mortuary Body Tray - Std - End Loading	2200 mm	600 mm	75 mm	300 kg
WAT903152	Mortuary Body Tray - Std - Side Loading	2200 mm	600 mm	75 mm	300 kg

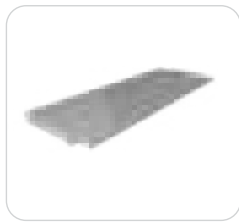

## Mortuary Body Tray - Bariatric - 350kg

- Stainless steel construction
- Push/pull handles both ends
- Angled sides allow for easy side transfer
- Tubular sub-frame
- Angled corners allow for easy cleaning and fluid removal



Code	Description	Length	Width	Height	S.W.L
WAT903160	Mortuary Body Tray - Bariatric - End Loading	2200 mm	800 mm	75 mm	350 kg
WAT903162	Mortuary Body Tray - Bariatric - Side Loading	2200 mm	800 mm	75 mm	350 kg

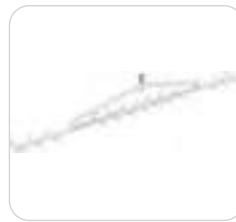

## Mortuary Spreader Bar - 363kg

- Multiple hook positions - 13 total
- Simple and fast attachment
- Epoxy powder coat finish
- Central hanging pivot point
- Mild steel heavy wall tubular frame
- Suitable for use with ceiling mounted lift systems & floor hoists



Code	Description	Length	Height	S.W.L
LIC354195	Mortuary Spreader Bar - 363kg	1580mm	165mm	363 kg



## Mortuary Spreader Bar - 200kg

- Optional Stretch Leveller allows for quick adjustment
- Can be used with a full lift sheet or with 4 lift straps
- Lightweight design weighing at 7.2kg
- Optional quick-release hook system is also available
- Compatible with Liko patient lifters & Liko ceiling hoists, Prism ceiling hoists, Aidacare A320, A205 and 200 lifters

Code	Description	Length	Width	Height	S.W.L
LSS394920	Mortuary Spreader Bar - 200 kg	1263 mm	617 mm	227 mm	200 kg



## Lifting Frame w/ Electric Tilt & Level - 350kg

- 5 hanger positions – Adjustable
- Simple and fast attachment
- Epoxy powder coat finish
- Central hanging pivot point
- Aluminium extrusion main frame
- Rechargeable battery
- Battery level indicator



Code	Description	Length	Width	Height	S.W.L
LIC354194	Lifting Frame w/ Electric Tilt & Level	1194 mm	488 mm	286 mm	350 kg

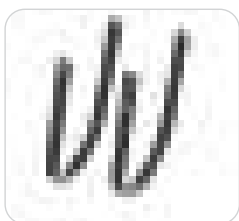

## Mortuary Spreader Bar Lifting Strap

- To be used in conjunction with the Morgue Sling (4 bands) to allow optimal transfers in morgue applications
- Suitable for use with Fixed Ceiling Lifts
- Compatible with Liko patient lifters & Liko ceiling hoists, Prism ceiling hoists, Aidacare A320, A205 and 200 patient lifters



Code	Description	Length	Width
LIC354197	Lifting strap - Short - 2 eyelets	1300 mm	80 mm
LIC354198	Lifting strap - Medium - 5 eyelets	1500 mm	80 mm
LIC354199	Lifting strap - Long - 5 eyelets	2000 mm	80 mm



## Ceiling Hoist Gantry

- Works with ceilings from 2133mm to 2743mm
- Span adjustable from 2100mm to 3000mm
- Easy to read pressure gauge indicator ensures safe installation
- Optional carry bag

Code	Description	Suits	S.W.L
LIC352120	Pressure Fit System	P200 Ceiling Hoist - LIC350110 CP200 Ceiling Hoist - LIC350105	200 kg



## Ceiling Hoist - Motor - P200 Portable

- Portable Hoist that can be used on the go
- Allows the client to be transferred from 'room to room' without the need to be disconnected from the hoist
- Quiet operation with 'soft start/ stop'
- Emergency Lowering Facility allows the safe lowering of the hoist in the unlikely event of failure of the controls
- Integrated Full Width Carry Bar with Unique Contoured Shape

Code	Description	Suits	S.W.L
LIC350110	P200 Portable Manual Traverse 200 kg quick release system	Ceiling Hoist Gantry - LIC352120	200 kg



## Ceiling Hoist - Motor - CP200 Portable

- Slimline, low profile, padded carry bar that has six loop attachments as standard (four-point hook optional). Different width carry bars also available
- Low profile hoist unit is unobtrusive and provides greater lifting height
- All lifting and traversing operations have soft start/stop to ensure smooth transfers for the patient

Code	Description	Suits	S.W.L
LIC350105	CP200 Portable Ceiling Hoist	Ceiling Hoist Gantry - LIC352120	200 kg



## Ceiling Hoist - Bariatric C380 Power Traverse

- Carry bar fitted with Quick Release System for simple interchange of carry bars
- Emergency stop/emergency lower
- Smooth stop start
- Bariatric four point carry bar
- Low profile hoist unit provides a great lift height

Code	Description	Suits	S.W.L
LIC350260	C-380P Power Traverse (Carry Bar Separate)	Installed Ceiling Hoist Track - LIC353120K	380 kg



## Ceiling Hoist - Motor - Transactive Xtra Fixed

- Slimline and with great lifting capacity
- Low profile hoist unit is unobtrusive and provides greater lifting height
- All lifting and traversing operations have soft start/stop to ensure smooth transfers for the patient
- A host of safety features
- Smooth running tape with large lifting range
- State of the art display with lift counter

Code	Description	Suits	S.W.L
LIC350170	Transactive - Manual Traverse & Carry bar	Installed Ceiling Hoist Track - LIC353120K (ALL)	200 kg
LIC350180	Transactive - Powered Traverse & Carry bar		200 kg
LIC350210	Transactive - Power Traverse & Carry bar		270 kg



## Casket Lowering System

- Coffin end stops
- Heavy duty engineered polymer rollers
- Epoxy powder coated steel frame
- Knock down construction for storage
- Lever action swing away support rollers
- Safety guide rail
- Coffin lowering assist guide rail
- Heavy duty construction

Sova / aidacare.com.au

Code	Description	S.W.L
WAT903290	Casket Lowering System - Manual	350 kg
WAT903300	Casket Lowering System - Electric	350 kg
WAT903310	Aluminium grave surround to suit casket lowering system	1000 kg

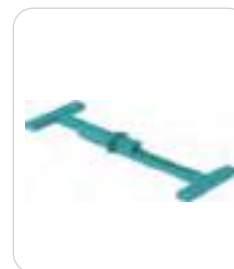

## Grave Spreader

- Epoxy powder coated
- Adjustable width settings

Sova / aidacare.com.au

Code	Description
WAT903320	Casket Lowering System - Manual





## Therapy & Exercise



## Contents

- P 376 Exercise & Resistance Training
- P 380 Physiotherapy - Other
- P 383 Enteral Feeding Pumps & Accessories
- P 385 Bracing & Supports - Neck & Shoulder
- P 389 Bracing & Supports - Trunk & Back
- P 395 Bracing & Supports - Arm & Elbow
- P 400 Bracing & Supports - Wrist & Hand
- P 416 Bracing & Supports - Knee
- P 425 Bracing & Supports - Thigh & Calf
- P 427 Bracing & Supports - Ankle
- P 432 Bracing & Supports - Foot & Toe
- P 440 Male Support

# Exercise & Resistance Training



For NDIS Item Code, refer to page: 508



## Aspire Exy Pedals



- Encourages the exercise of semi-recumbent people who are not highly mobile
- Can be used for legs and arms
- Lightweight, allowing for easy transportation and storage
- No assembly required
- Digital model allows for resistance and time to be set

Code	Description	Warranty	DVA:
FPP292810	Aspire Exy Pedal - Digital	1 Year	-
FPP292800	Aspire Exy Pedal - Manual	1 Year	AV02



## Exercise Bike - Performance Upright Bike

- 8 levels of manual resistance
- 4kg flywheel
- 1 piece crank
- LCD screen
- Hand pulse sensors
- Large cushioned, vertical adjustable seat
- Adjustable stabilizer for uneven surfaces
- Wheels for transportation

Code	Description	Length	Width	Height	S.W.L	Warranty	DVA:
FPP290610	Exercise Bike	930 mm	480 mm	1190 mm	100 kg	1 Year	AV01



## Hand Grips

- Designed to provide resistance to hands for general strengthening and conditioning
- Sold as a pair

Code	Description	Weight	Warranty
FPP290440	Hand Grips	Medium	1 Year
FPP290450	Hand Grips	Strong	1 Year
FPP290460	Hand Grips	Extra Strong	1 Year



## Soft Ankle/Wrist Weights

- Soft Ankle/Wrist Weights for strengthening ankles, legs and arms
- One size fits most

Code	Description	Weight	Colour	Warranty
FPP290480	Soft Ankle/Wrist Weight 0.5	0.5 kg	Grey	1 Year
FPP290470	Soft Ankle/Wrist Weight 1	1.0 kg	Grey	1 Year
FPP290490	Soft Ankle/Wrist Weight 1.5	1.5 kg	Grey	1 Year
FPP290500	Soft Ankle/Wrist Weight 2	2.0 kg	Grey	1 Year



## Exercise Putty

- Exercise putty designed to strengthen and rehabilitate hand & finger muscles
- Less oily than other traditional putty, non-toxic and bleed proof
- Leaves no colour or residue on the client's hands

Code	Description	Weight	Colour	Warranty	DVA:
FPP298100	Exercise Putty - Super Soft	0.85 kg	Tan	6 months	AV10
FPP298200	Exercise Putty - Soft	0.85 kg	Yellow	6 months	AV10
FPP298300	Exercise Putty - Medium	0.85 kg	Red	6 months	AV10
FPP298400	Exercise Putty - Medium Firm	0.85 kg	Green	6 months	AV10
FPP298500	Exercise Putty - Firm	0.85 kg	Blue	6 months	AV10

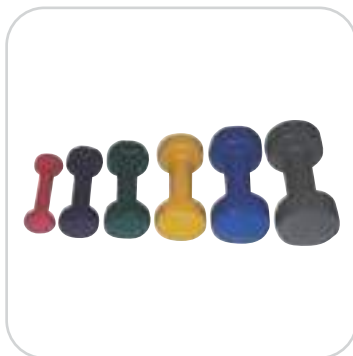

## PVC Dipped Dumbbells

- Dumbbells used for strengthening and exercise or therapy
- Large range of weights available

Code	Description	Weight	Colour	Warranty
FPP290310	PVC Dipped Dumbbell	0.5 kg	Pink	1 Year
FPP290320	PVC Dipped Dumbbell	1.0 kg	Purple	1 Year
FPP290330	PVC Dipped Dumbbell	1.5 kg	Green	1 Year
FPP290340	PVC Dipped Dumbbell	2.0 kg	Yellow	1 Year
FPP290350	PVC Dipped Dumbbell	2.5 kg	Red	1 Year
FPP290360	PVC Dipped Dumbbell	3.0 kg	Blue	1 Year
FPP290370	PVC Dipped Dumbbell	4.0 kg	Grey	1 Year
FPP290380	PVC Dipped Dumbbell	5.0 kg	Black	1 Year



## Thera-Band Soft Weights

- Provide more versatility for strength training and rehabilitation exercises
- Hand-held, ball-shaped isotonic weights

Code	Description	Weight	Colour
FPP290381	Thera-Band Soft Weight	0.5 kg	Tan
FPP290382	Thera-Band Soft Weight	1.0 kg	Yellow
FPP290383	Thera-Band Soft Weight	1.5 kg	Red
FPP290384	Thera-Band Soft Weight	2.0 kg	Green
FPP290385	Thera-Band Soft Weight	2.5 kg	Blue
FPP290386	Thera-Band Soft Weight	3.0 kg	Black



## Thera-Band Retail Pack

- Thera-Band Retail Pack conveniently packaged for users requiring increased levels of resistance
- 3 bands of different resistance levels per pack

Code	Description	Length	Width	Colour	Resistance	DVA:
FPP310900	Thera-Band Retail Pack - Light	1.5m x 3	140 mm	Yellow, Red, Green	Low, Medium, Heavy	AV10
FPP311000	Thera-Band Retail Pack - Heavy	1.5m x 3	140 mm	Green, Blue, Black	Heavy, Extra Heavy & Special Heavy	AV10



## Thera-Band Dispenser Bands

- Thera-Band Dispenser system provides the ideal length for individual exercises
- Stretchable latex rubber in five colour-coded resistances in lengths of 152 cm
- Available as individual packets or as a complete dispenser system

Code	Description	Length	Width	Colour	Resistance	DVA:
FPP308450	Thera-Band 152	152 cm	140 mm	Yellow	Low	AV10
FPP308451	Thera-Band 152	152 cm	140 mm	Red	Medium	AV10
FPP308452	Thera-Band 152	152 cm	140 mm	Green	Heavy	AV10
FPP308453	Thera-Band 152	152 cm	140 mm	Blue	Extra Heavy	AV10
FPP308454	Thera-Band 152	152 cm	140 mm	Black	Special Heavy	AV10





## Thera-Band Stability Trainer

- Supplied in three densities to provide a progressive system of balance training
- Made of durable PVC
- Anti-slip ridged surface and oval foot fitting shape

Code	Description	Colour	Resistance
FPP311282	Thera-Band Stability Trainer	Black	X-Soft
FPP311280	Thera-Band Stability Trainer	Blue	Soft
FPP311281	Thera-Band Stability Trainer	Green	Firm



## Thera-Band

- Thera-Band Exercise Bands for resistive exercise or therapy
- Colour-coded for progressive resistance strengths

Code	Description	Length	Width	Colour	Resistance
FPP308500	Thera-Band	5.5 m	140 mm	Yellow	Low
FPP308600	Thera-Band	5.5 m	140 mm	Red	Medium
FPP308700	Thera-Band	5.5 m	140 mm	Green	Heavy
FPP308800	Thera-Band	5.5 m	140 mm	Blue	Extra Heavy
FPP308900	Thera-Band	5.5 m	140 mm	Black	Special Heavy
FPP309000	Thera-Band	45.5 m	140 mm	Yellow	Low
FPP309100	Thera-Band	45.5 m	140 mm	Red	Medium
FPP309200	Thera-Band	45.5 m	140 mm	Green	Heavy
FPP309300	Thera-Band	45.5 m	140 mm	Blue	Extra Heavy
FPP309400	Thera-Band	45.5 m	140 mm	Black	Special Heavy



## Thera-Band Tubing Retail Pack

- Thera-Band Tubing Retail Pack conveniently packaged for user requiring increased levels of resistance.
- 3 tubes of different resistance levels per pack

Code	Description	Length	Width	Colour	Resistance
FPP311100	Thera-Band Tubing Retail Pack - Light	1.83 m x 3	140 mm	Yellow, Red, Green	Low, Medium, Heavy
FPP311200	Thera-Band Tubing Retail Pack - Heavy	1.83 m x 3	140 mm	Green, Blue, Black	Heavy, Extra Heavy, Special Heavy



## Thera-Band Tubing

- Thera-Band Exercise Tubing is a natural rubber tubing available in 6 colour-coded levels of resistance
- Improves strength, range of motion and cooperation of muscle groups

Code	Description	Length	Colour	Resistance
FPP310400	Thera-Band Tubing	7.5 m	Yellow	Low
FPP310500	Thera-Band Tubing	7.5 m	Red	Medium
FPP310600	Thera-Band Tubing	7.5 m	Green	Heavy
FPP310700	Thera-Band Tubing	7.5 m	Blue	Extra Heavy
FPP310800	Thera-Band Tubing	7.5 m	Black	Special Heavy
FPP310850	Thera-Band Tubing	7.5 m	Silver	Super Heavy
FPP309900	Thera-Band Tubing	30 m	Yellow	Low
FPP309800	Thera-Band Tubing	30 m	Red	Medium
FPP309700	Thera-Band Tubing	30 m	Green	Heavy
FPP309600	Thera-Band Tubing	30 m	Blue	Extra Heavy
FPP309500	Thera-Band Tubing	30 m	Black	Special Heavy
FPP309450	Thera-Band Tubing	30 m	Silver	Super Heavy



## Thera-Band Assist Strap

- Thera-Band Assist Strap is an attachment designed to increase exercises with bands or tubing
- Assists users with weakened grip to use bands and tubing

Code	Description	DVA:
FPP310010	Thera-Band Assist Strap	AV10



## Thera-Band Tubing with Handles

- Thera-Band Resistance Tubing with Handles for convenient, ready-to-use clinical or home solutions
- Available in 6 Thera-Band colours and resistances

Code	Description	Length	Colour	Resistance	DVA:
FPP309910	Thera-Band Tubing with Handle	121 cm	Yellow	Low	AV10
FPP309911	Thera-Band Tubing with Handle	121 cm	Red	Medium	AV10
FPP309912	Thera-Band Tubing with Handle	121 cm	Green	Heavy	AV10
FPP309913	Thera-Band Tubing with Handle	121 cm	Blue	Extra Heavy	AV10
FPP309914	Thera-Band Tubing with Handle	121 cm	Black	Special Heavy	AV10
FPP309915	Thera-Band Tubing with Handle	121 cm	Silver	Super Heavy	AV10



## Thera-Band Tubing with Padded Cuffs

- Resistance Tubing with padded cuffs for convenient, ready-to-use clinical or home solutions
- Sturdy design with comfortable, no-slip cuffs
- Ideal for sports performance enhancement and advanced injury rehabilitation

Code	Description	Colour	Resistance	DVA:
FPP309920	Thera-Band Tubing with Padded Cuffs	Red	Beginner/Intermediate	AV10
FPP309921	Thera-Band Tubing with Padded Cuffs	Green	Intermediate	AV10
FPP309922	Thera-Band Tubing with Padded Cuffs	Blue	Intermediate/Advanced	AV10
FPP309923	Thera-Band Tubing with Padded Cuffs	Black	Advanced	AV10



## Thera-Band Sports Handle

- Extra long Theraband Sports Handle allows for two hands to grasp it easily
- Attached easily to bands or tubing to provide ideal grip for exercising
- Designed for use with bands and/or tubing

Code	Description	DVA:
FPP310020	Thera-Band Sports Handle	AV10



## Thera-Band FlexBar

- Thera-Band FlexBar is a flexible, durable resistance device
- Research-proven effective for Tennis Elbow
- Ridged surface for enhanced grip
- Used to improve grip strength and upper extremity stabilisation

Code	Description	Colour	Resistance	DVA:
FPP311205	Thera-Band FlexBar	Yellow	X-Light	AV10
FPP311210	Thera-Band FlexBar	Red	Light	AV10
FPP311220	Thera-Band FlexBar	Green	Medium	AV10
FPP311230	Thera-Band FlexBar	Blue	Heavy	AV10



## Thera-Band Exercise Handles

- Thera-Band Exercise Handles have soft, comfortable grip and can be used with both the exercise band and tubing

Code	Description	DVA:
FPP310000	Thera-Band Exercise Handles (Pair)	AV10



## Thera-Band Hand Trainer

- Thera-Band Progressive Hand Trainer assists patients recovering from hand or wrist surgery
- Colour-coded for progressive resistance exercises
- Helps improve hand, finger and thumb strength and mobility during hand rehabilitation
- Intro Kit contains instruction guide to demonstrate proper exercises

Code	Description	DVA:
FPP311250	Thera-Band Hand Trainer, Intro Kit	AV10



## Thera-Band Shoulder Pulley

- Thera-Band Shoulder Pulley is designed to assist patients undergoing shoulder rehab
- Features a unique rope divided into sections for immediate feedback on progress

Code	Description
FPP311260	Thera-Band Shoulder Pulley

# Physiotherapy - Other



For NDIS Item Code, refer to page: 508



## TENS Unit

- Electro stimulation pack assists with therapy and pain relief
- Designed to assist with light to moderate pain relief
- Supplied with 9 volt battery, leads and 1 packet of electrodes
- Can be used by professionals or in the home

Code	Description	Warranty	DVA:
FPP315200	TENS Unit	1 Year	BD03
GSP342245	Replacement Electrodes (Pkt 4)		BD04
GSP342240	Charger		BD04
GSP342230	Batteries		BD04



## Premium Rigid Strapping Tape

- Provides maximum support and protection against injury during sport
- Assists in recovery from injury
- Extra strong adhesive with pinked edge

Code	Description	Width	Length
GMS337057	Premium Rigid Strapping Tape	38 mm	13.7 m



## BodyAssist Elastic Strap (Multi-Purpose)

- Multi-purpose elastic strap attaches to itself in any position
- Ideal for binding knees, thighs and the abdomen
- Can be fitted anywhere on the body
- Designed to stabilise and assist healing of injured soft tissue
- One size fits most

Code	Description	Colour	Length	Warranty	DVA:
FBS283560	Elastic Strap	Black	1 m	1 Year	AR01
FBS280490	Elastic Strap	Beige	1 m	1 Year	AR01
FBS280495	Elastic Strap	White	1 m	1 Year	AR01



## BodyAssist Elastic Strap with Loop

- Multi purpose elastic strap with a loop sewn at one end for effective wrapping
- Ideal for wrists, arms, ankles, calves and forearms
- Designed to stabilise and assist healing of injured soft tissue
- One size fits most

Code	Description	Colour	Length	Warranty	DVA:
FBS283540	Elastic Strap with Loop	Black	700 mm	1 Year	AR01
FBS283550	Elastic Strap with Loop	Beige	700 mm	1 Year	AR01
FBS283555	Elastic Strap with Loop	White	700 mm	1 Year	AR01



### Micro Professional Heat Pack

- Micro professional range ideal for use in institutions
- Meets all the necessary health and safety requirements

Code	Description
FPP292140	Micro Professional Heat Pack Standard - 300 x 300 mm
FPP292150	Micro Professional Heat Pack - Neck



### Lupin Hot/Cold Pack (Back)

- Easily moulds to the contour of the lower back
- Adjustable belt
- Hands free relief without interrupting daily commitments
- One size fits all
- Can be used Hot or Cold
- Fabric is 100% natural cotton corduroy
- "Low allergy" alternative to wheat, more resistant to moisture (to make cleaning easier) and less weight for more comfort

Code	Description	Warranty
FPP292151	Lupin Hot/Cold Pack Back	1 Year



### Lupin Hot/Cold Pack Body Pillow

- Forms to your body shape and is suitable for all parts of the body
- Can be used Hot or Cold
- Fabric is 100% natural cotton corduroy
- "Low allergy" alternative to wheat, more resistant to moisture (to make cleaning easier) and less weight for more comfort

Code	Description	Width	Length	Warranty
FPP292152	Lupin Hot/Cold Pack Body Pillow	400 mm	190 mm	1 Year



### Lupin Hot/Cold Pack Square

- Forms to your body shape and is suitable for all parts of the body
- Can be used Hot or Cold
- Fabric is 100% natural cotton corduroy
- "Low allergy" alternative to wheat, more resistant to moisture (to make cleaning easier) and less weight for more comfort

Code	Description	Width	Length	Warranty
FPP292153	Lupin Hot/Cold Pack Square	200 mm	200 mm	1 Year



### Lupin Hot/Cold Pack Rectangle

- Forms to your body shape and is suitable for all parts of the body
- Can be used Hot or Cold
- Fabric is 100% natural cotton corduroy
- "Low allergy" alternative to wheat, more resistant to moisture (to make cleaning easier) and less weight for more comfort

Code	Description	Width	Length	Warranty
FPP292154	Lupin Hot/Cold Pack Rectangle	330 mm	130 mm	1 Year



### Lupin Hot/Cold Pack Shoulder Wrap

- Will assist to soothe neck and shoulder pain, muscular stress and mastitis
- Can be used Hot or Cold
- Fabric is 100% natural cotton corduroy
- "Low allergy" alternative to wheat, more resistant to moisture (to make cleaning easier) and less weight for more comfort

Code	Description	Warranty
FPP292155	Lupin Hot/Cold Pack Shoulder Wrap	1 Year



### Lupin Hot/Cold Pack Hand Glove

- Unique hot or cold mitt
- Low allergy alternative to wheat
- Easy to use and an excellent treatment for arthritis, rheumatism and general circulation

Code	Description	Warranty
FPP292156	Lupin Hot/Cold Pack Hand Glove	1 Year



### Fitness Ball

- Widely used for physiotherapy and perceptual motor training
- Rated to 300kg
- Seamless construction with anti-burst to withstand rugged use
- Available in assorted colours

Code	Description	Diameter	User Height	S.W.L	Warranty
FPP303000	Fitness Ball 45cm	45 cm	<150 cm	300 kg	1 Year
FPP303300	Fitness Ball 55cm	55 cm	150 -160 cm	300 kg	1 Year
FPP303500	Fitness Ball 65cm	65 cm	160 -180 cm	300 kg	1 Year
FPP303600	Fitness Ball 75cm	75 cm	180 -196 cm	300 kg	1 Year
FPP303750	Fitness Ball 85cm	85 cm	195 cm>	300 kg	1 Year
FPP303800	Fitness Ball 100cm	100 cm	-	300 kg	1 Year



### Stress Ball

- Designed for temporary relief of stress or as a rehabilitation tool for fine motor skills
- Specifically exercises the hand, wrist and forearm

Code	Description	Diameter	Warranty
FPP312400	Stress Ball	65 mm	6 months



### Balance Wobble Board

- Balance board for therapy or exercise
- Designed for rehabilitation and strengthening of ankles
- Surface grooves for grip and stability
- Highly durable, strong and hard wearing

Code	Description	S.W.L	Warranty
FPP304000	Balance Wobble Board	500 kg	1 Year



### Wobble Board

- Timber balance board for therapy or exercise
- Highly durable, strong and hard wearing
- Designed for rehabilitation and strengthening of ankles

Code	Description	Warranty
FPP292700	Wobble Board	1 Year



### Stability Disc

- Stability disc has the benefits of both the fitness ball and the sitting wedge
- Can be used on any type of chair or stool
- Promotes upright posture and improves balance
- Conveniently portable

Code	Description	Diameter	Warranty
FPP305000	Stability Disc	330 mm	1 Year



### Freestanding Parallel Bars

- Freestanding Parallel Bars used for mobility training and therapy
- Widely used in therapy centres
- Adjustable legs for easy set-up
- Foldable for easy storage
- 3 year warranty

Code	Model	Width	Length	Height	S.W.L
FPP307600	Freestanding Parallel Bars	650 mm	2500 mm	640 - 1065 mm	130 kg



For Mobility  
Walking Aids  
Refer to Page 253



# Enteral Feeding Pumps & Accessories

**I ♥ ndis** For NDIS Item Code, refer to page: 508



## Flocare Infinity Pump

- The Flocare Infinity Pump safely and accurately delivers a nutritional regimen without compromising quality of life
- Small, lightweight and portable to suit any situation
- Built to simplify the enteral feeding experience

Code	Description	Manufacturer	DVA:
MDC402300	Enteral Feeding Pump - Flocare Infinity Pump	Nutricia	AS14



## Kangaroo ePump

- The Kangaroo ePump system is the latest innovation in enteral feeding technology
- When patients require nutrition through continuous feeding, intermittent feeding or feeding and flushing, Kangaroo ePump enteral feeding pump delivers in one compact, easy to use device

Code	Description	Manufacturer	DVA:
MDC402310	Enteral Feeding Pump - Kangaroo ePump	Medtronic	AS14



## Kangaroo Joey Pump

- The Kangaroo Joey Pump provides feeding and flushing in a completely portable device
- This feeding pump is the first hydrating and ambulatory enteral device available
- It assures clinicians of accurate and reliable function while providing patients with freedom and mobility

Code	Description	Manufacturer	DVA:
MDC402320	Enteral Feeding Pump - Kangaroo Joey Pump	Medtronic	AS14



## FreeGo Pump

- The FreeGo Pump is a safe, simple and easy to use pump that provides for accurate, controlled enteral feeding in a user-friendly operating system
- Suitable for adults and children, the FreeGo Pump is small and lightweight for portable and bedside use

Code	Description	Manufacturer
MDC402305	Enteral Feeding Pump - FreeGo Pump	Abbott

## Enteral Feeding Pump Accessories & Consumables

Code	Description	Single Use Only	Unit	Manufacturer	DVA:
MDC402330	Flocare Infinity Pack Giving Set - Transition	Y	30	Nutricia	AS15
MDC402340	Flocare Infinity Pack Mobile Giving Set - Transition	Y	30	Nutricia	AS15
MDC402350	Flocare Infinity Pack Giving Set - No Port - Transition	Y	30	Nutricia	AS15
MDC402360	Flocare Infinity Pack Mobile Giving Set - No Port - Transition	Y	30	Nutricia	AS15
MDC402370	Flocare Gravity Pack Set - Leur Free - Transition	Y	30	Nutricia	AS15
MDC402380	Flocare Infinity Pack Set - Leur Free - Transition	Y	30	Nutricia	AS15
MDC402390	Flocare Infinity Bottle Giving Set - No Port - Transition	Y	30	Nutricia	AS15
MDC402400	Flocare Infinity Bottle Giving Set - Transition	Y	30	Nutricia	AS15
MDC402410	Flocare Gravity Pack & Bottle Set - Leur Free - Transition	Y	30	Nutricia	AS15
MDC402420	Flocare Infinity Bottle Set - Leur Free - Transition	Y	30	Nutricia	AS15
MDC402430	CH14 Balloon 5ml - Green	Y	2	Nutricia	AS15
MDC402440	CH18 Balloon 15ml - Red	Y	2	Nutricia	AS15
MDC402450	CH20 Balloon 15ml - Yellow	Y	2	Nutricia	AS15
MDC402460	Flocare Container 1L	Y	10	Nutricia	AS15
MDC402470	Flocare Container 0.5L	Y	10	Nutricia	AS15
MDC402480	Feeding Conector CH18 - Red	Y	30	Nutricia	AS15
MDC402490	Universal Pack Adaptor	Y	30	Nutricia	AS15
MDC402500	Infinity Stand	--	1	Nutricia	AS15
MDC402510	Infinity Backpack - Adult	--	1	Nutricia	AS15
MDC402520	Joey Mini Backpack - Blue	--	1	Medtronic	AS15
MDC402530	Joey Mini Backpack - Pink	--	1	Medtronic	AS15
MDC402540	Joey Enplus 3-in-1 Set	Y	30	Medtronic	AS15
MDC402550	Joey 1000ml Pump Set	Y	30	Medtronic	AS15
MDC402560	Joey Enplus 3-in-1 & 1L Flush	Y	36	Medtronic	AS15
MDC402570	Joey 1000ml Feed / Flush Set	Y	30	Medtronic	AS15
MDC402580	Epump 1000ml Pump Set	Y	30	Medtronic	AS15
MDC402590	Epump Enplus Spike Set	Y	30	Medtronic	AS15
MDC402600	Epump Enplus 3-in-1 Set	Y	30	Medtronic	AS15
MDC402610	Epump Enplus Spike & 1000ml Flush Set	Y	30	Medtronic	AS15
MDC402620	Epump Enplus 3-in-1 & 1L Flush Set	Y	36	Medtronic	AS15
MDC402630	Epump Safety Screw Spike / Flush	Y	30	Medtronic	AS15
MDC402640	Gravity Set (DEHP Free)	Y	30	Medtronic	AS15
MDC402650	FreeGo Backpack	--	1	Abbott	AS15
MDC402660	FreeGo Drip Stand	--	1	Abbott	AS15
MDC402670	FreeGo Pump Giving Set Enfit	Y	30	Abbott	AS15
MDC402680	Terumo 50ml Catheter Tip Syringe	Y	20	CH2	AS15
MDC402690	BD 50ml Catheter Tip Syringe	Y	60	CH2	AS15
MDC402720	Gravity Screw Cap Giving Set 9 (Feeding Line Only)	Y	30	CH2	AS15
MDC402730	Flexitainer 1000ml	Y	30	CH2	AS15
MDC402740	Flexitainer 500ml	Y	30	CH2	AS15



# Bracing & Supports - Neck & Shoulder

**I ♥ ndis** For NDIS Item Code, refer to page: 508



## Cosmac Soft Foam Collar

- Washable polyurethane foam covered with stockinette
- Velcro fastening
- Sizing: (1) measure depth (cm) from chin to clavicle (2) measure neck circumference for length



## Philadelphia Collar

- Anterior piece cradles mandible to enhance rotation control
- Made of light, strong foam, easy to trim
- Bilateral velcro fastening
- Sizing: (1) measure depth (cm) from chin to clavicle (2) measure neck circumference (S, M or L)

Code	Size	Depth (cm)	Length (cm)	DVA:
FBS301201	Small	7.5	28 - 35	AR18
FBS301202	Small/Long	7.5	35 - 43	AR18
FBS301203	Medium	8.0	28 - 35	AR18
FBS301204	Medium/Long	8.0	35 - 43	AR18
FBS301205	Large	10.0	35 - 43	AR18
FBS301206	XLarge	11.0	38 - 46	AR18

Depth (cm)	Small (25 - 30cm)	Medium (33 - 40cm)	Large (40 - 46cm)	DVA:
6	FBS301207	FBS301207AM	FBS301207AL	AR18
8	FBS301207BS	FBS301207BM	FBS301207BL	AR18
11	FBS301207CS	FBS301207CM	FBS301207CL	AR18
13	FBS301207DS	FBS301207DM	FBS301207DL	AR18



## Exo 101 Firm Collar

- Designed for symptomatic relief of neck pain or injury
- Made of polyethylene plastic, with vinyl-covered foam padding
- Height adjustable from 12.5 to 14.5cm
- Air holes for ventilation and hook-and-loop closure



## Oppo 4190 Rigid Adj Collar w/ chin

- Completely height-adjustable to provide desired flexion or extension positioning
- Vinyl-covered foam padding for patient's comfort and easy cleaning
- Ventilated to allow air circulation
- Hook and loop closure for quick, easy application and removal

Code	Size	Neck (cm)	DVA:
FBS301208	Small	31 - 37	AR18
FBS301208M	Medium	35 - 41	AR18
FBS301208L	Large	40 - 45	AR18

Note: Measure around the circumference of the neck.

Code	Size	Neck (cm)	DVA:
FBS301210	Small	34.3 - 40	AR18
FBS301210M	Medium	40 - 46.4	AR18
FBS301210L	Large	46.4 - 52.7	AR18

Note: Measure around the circumference of the neck.

### DVA Contact Details

P 1300 888 052 | F 1300 787 052 | E [dva@aidacare.com.au](mailto:dva@aidacare.com.au)

**I ♥ ndis** For NDIS Item Code, refer to page: 508

**aidacare**  
HEALTHCARE EQUIPMENT





## Aspen Collar - Adult

- Designed to optimise support and comfort, the key components for better patient outcomes
- All contact surfaces of the collar are cushioned with cotton-lined, breathable foam padding
- Provides substantial motion restriction without producing painful pressure points that can lead to skin breakdown or poor patient compliance

Code			Size	Top of Shoulders to Chin (cm)	Neck (cm)	DVA:
Collar (1 set of pads)	Collar Set (2 sets of pads)	Replacement Pads				
FBS301211	FBS301215	FBS301219	Adult Short	2	33 - 53	AR18
FBS301212	FBS301216	FBS301219AR	Adult Regular	2 - 3	33 - 53	AR18
FBS301213	FBS301217	FBS301219AT	Adult Tall	3 - 5	33 - 53	AR18
FBS301214	FBS301218	FBS301219AXT	Adult X/Tall	5+	33 - 53	AR18

Note: Measure (1) top of shoulders to chin and (2) around the circumference of the neck.



## Miami-J Collar - Adult

- A phenotype-driven sizing system - with unique fronts and backs that are bioengineered to work together for superior immobilisation - makes size selection simple, while drastically reducing the margin of error in fitting a patient
- Adjustable mandibular and occipital support enables customisation to disperse pressure and avoid skin breakdown
- Sorbatex™ pads that are specifically engineered to be anti-decubitus - protecting skin integrity during extended wear - and are removable for easy cleaning
- Sternal pad disperses pressure and is removable for comfort and improved compliance when supine and/or swallowing
- Patient assist strap allows for flexibility and comfort without sacrificing immobilisation

	Code			Size	Sizing Guidelines	DVA:	
	Collar (1 set of pads)	Collar Set (2 sets of pads)	Replacement Pads				
Standard Sizes: > 70% of Population	FBS301221	FBS301226	FBS301232	Small	• Standard for mature men • Short-necked women	AR18	
	FBS301222	FBS301227	FBS301232M	Medium	• Standard for mature women • Thin, mature men	AR18	
	FBS301223	FBS301228	FBS301232L	Large	• Long, tall neck • 'Swan' neck	• Young women • Adolescents	AR18
Specialty Sizes: < 30% of Population	FBS301224	FBS301229	FBS301233	Stout	• Very large neck circumference • Obese	• 'No neck' • Massive shoulders	AR18
	FBS301225	FBS301230	FBS301232SS	Super, Short	• Kyphotic (chin-on-chest) neck • Geriatric • Osteoporitic and/or ankylosing spondylitic		AR18
	FBS301220	FBS301231	FBS301234	X-Small	• Very short, thin neck principally female • More prevalent in Asian population • Rare		AR18



## BodyAssist N71 Thermal Shoulder Brace

- Provides soft tissue support & compression
- Increases elasticity of muscles, ligaments & tendons
- Assists in prevention of injury or re-injury
- Elastic support strap fits comfortably under the arm pit & assists to generate better than average compression & support to the shoulder
- Can be worn while playing sports
- Multi-directional compression assists to reduce soft tissue swelling
- Promotes greater blood circulation, provides a more speedy recovery
- Contoured panels fit most body shapes
- Completely washable & hygienic
- Stabiliser strap is optional

Code - Shoulder Brace					Code - Stabiliser Strap	Size	To Fit	(cm)	DVA:
Left	Right	Size	(cm)	DVA:					
FBS281398	FBS281403	XS	80 - 90	AR03	FBS285281	Regular	To Fit Brace XS to M	80 - 90	AR02
FBS281399	FBS281405	S	90 - 100	AR03	FBS285282	Large	To Fit Brace M to XL	90 - 100	AR02
FBS281400	FBS281406	M	100 - 110	AR03					
FBS281401	FBS281407	L	110 - 120	AR03					
FBS281402	FBS281408	XL	120 - 130	AR03					

Note: Measure circumference around chest, around outside of arm on affected side (refer illustration).





## Oppo 1072 Shoulder Support

- Provides compression and support to shoulder and aids healing
- Therapeutic warmth for the shoulder and upper arm
- Offers support and protection
- Minimises potential for future injuries
- Fits left or right

Code	Size	Chest (cm)	DVA:
FBS301236	Small	83.2 - 93.3	AR03
FBS301236M	Medium	93.3 - 103.5	AR03
FBS301236L	Large	103.5 - 113.7	AR03
FBS301236XL	X-Large	113.7 - 126.4	AR03

Note: Measure around the chest (cm).



## Oppo 2172 Reinforced Shoulder Support

- Two reinforced elastic straps on upper arm provide extra support for the shoulder
- Allows the patient gradually return to full range of motion
- Fits left or right

Code	Size	Chest cm	DVA:
FBS301237	Small	81.6 - 91.8	AR03
FBS301237M	Medium	91.8 - 101.9	AR03
FBS301237L	Large	101.9 - 114.6	AR03
FBS301237XL	X-Large	114.6 - 127.3	AR03

Note: Measure around the chest (cm).



## Oppo 2075 Clavicle Brace

- Excellent aid in correcting poor posture and shoulder slump
- Adjustable hook and loop closure facilitates proper fit

Code	Size	(cm)	DVA:
FBS301239	S	53.7 - 63.8	AR03
FBS301239M	M	63.8 - 76.5	AR03
FBS301239L	L	76.5 - 89.2	AR03
FBS301239XL	XL	89.2 - 104.5	AR03
FBS301239XXL	XXL	104.5 - 117.2	AR03
FBS301239XXXL	XXXL	117.2 - 129.9	AR03

Note: Measure around scapula under arm.



## Oppo 4072 Humerus Brace

- Padded webbing strap fits under the opposite axilla
- Hook and loop closure for quick, easy, adjustable application and removal

Code	Size	Mid Upper Arm (cm)	DVA:
FBS301240	S	24 - 29	AR03
FBS301240M	M	29 - 34	AR03
FBS301240L	L	34 - 39	AR03

Note: Measure mid upper arm circumference (cm).



## Rehband 5055 Acro Comfort Shoulder Support

- Stabilises the shoulder joint
- Stretch flex system is anatomically designed for optimal function
- Excellent comfort through the temperature regulating features of comfortemp®
- Fits left or right

Code	Size	(cm)	DVA:
FBS301257	X-Small	24 - 28	AR03
FBS301257S	Small	28 - 32	AR03
FBS301257M	Medium	32 - 35	AR03
FBS301257L	Large	35 - 38	AR03
FBS301257XL	X-Large	38 - 42	AR03

Note: Measure circumference around the shoulder joint going under the arm (cm).



## Rehband 7126 Shoulder Support

- Soft and flexible shoulder support with excellent fit
- Provides warmth and pain relief to the shoulder joint

Code		Size	Chest (cm)	DVA:
Left	Right			
FBS301235	FBS301235XSR	X-Small	24 - 28	AR03
FBS301235SL	FBS301235SR	Small	28 - 32	AR03
FBS301235ML	FBS301235MR	Medium	32 - 35	AR03
FBS301235LL	FBS301235LR	Large	35 - 38	AR03
FBS301235XLL	FBS301235XLR	X-Large	38 - 42	AR03

Note: Measure around the chest (cm).

### DVA Contact Details

P 1300 888 052 | F 1300 787 052 | E [dva@aidacare.com.au](mailto:dva@aidacare.com.au)



For NDIS Item Code, refer to page: 508



## Rolyan MFC II Shoulder Orthosis

- Lycra/spandex fabric offers excellent conformability to body contours for a snug fit
- Easy to put on and take off
- Can be worn under clothing
- Hand wash, air dry

Code		Size	Mid Upper Arm (cm)	DVA:
Left	Right			
FBS301251	FBS301252	X-Small	23 - 28	AR03
FBS301253	FBS301254	Small	28 - 33	AR03
FBS301255	FBS301256	Medium	33 - 38	AR03

Note: Measure circumference of mid upper-arm.



## Rolyan Hemi Arm Sling II

- Positions the head of the humerus in the glenoid fossa and the scapula in external rotation
- Optional universal cuff adapter A653-11 available - positions the hand above heart to treat or prevent oedema. Attaches to a d-ring on the unaffected side
- Length 18cm, colour white
- Elastic straps are dynamic, allowing a patient to actively move returning muscles and perform self-ranging exercises
- Approximately 3.8cm longer than the original model

Code		Size	(cm)	Chest (cm)	DVA:
Left	Right				
FBS301241	FBS301242	Small	36 - 46	-	AR03
FBS301243	FBS301244	Medium	46 - 61	78 - 89	AR03
FBS301245	FBS301246	Medium - Long	46 - 61	89 - 102	AR03
FBS301247	FBS301248	Long	61 - 71	-	AR03
FBS301249	FBS301250	X-Large	71 - 86	-	AR03

Note: To fit, measure the distance from acromion to acromion posteriorly across the midpoint of the scapula. To determine if patient is medium or medium long, measure the chest circumference at the axilla.





# Bracing & Supports - Trunk & Back

**I ♥ ndis** For NDIS Item Code, refer to page: 508



## Oppo 2060 Abdominal Binder - Firm

- Made of a combination of elastic and soft nylon pile bonded to 6mm foam for comfort
- Elastic panel construction provides even support; prevents "roll over"
- Contoured to fit between waist and hips

Code	Size	Waist (cm)	DVA:
FBS301269	Small	61.6 - 81.3	AR14
FBS301269M	Medium	81.3 - 94	AR14
FBS301269L	Large	94 - 104.1	AR14
FBS301269XL	X-Large	104.1 - 114.3	AR14
FBS301269XXL	XX-Large	114.3+	AR14

Note: Measure around the waist.



## Oppo 2265 Lumbar Sacral Support - Tapered

- Four removable posterior flexible aluminum stays support the lower back
- Two flexible stays in front help reduce rolling of the support when sitting
- Allows limited flexion and extension
- 25cm high at back, tapered to 17.5cm at front

Code	Size	Waist (cm)	DVA:
FBS301278	Small	58.4 - 71.1	AR08
FBS301278M	Medium	71.1 - 83.8	AR08
FBS301278L	Large	83.8 - 96.5	AR08
FBS301278XL	X-Large	96.5 - 109.2	AR08
FBS301278XXL	XX-Large	109.2 - 121.9	AR08

Note: Measure around the waist.



## Rehband 1068 EQ Posture Support

- A flexible aid for training a better posture
- Bendable stays for additional support
- Elastic and well-fitting
- Wear with singlet or t-shirt underneath

Code	Size	Waist (cm)	DVA:
FBS301258	X-Small	56 - 64	AR03
FBS301258S	Small	64 - 72	AR03
FBS301258M	Medium	72 - 80	AR03
FBS301258L	Large	80 - 90	AR03
FBS301258XL	X-Large	90 - 100	AR03

Note: Measure waist circumference (cm).



## Oppo 2175 Posture Aid

- Triangle configuration correctly distributes pressure to tip of shoulder
- Suitable for adults or children
- Adjustable hook and loop closure facilitates proper fit

Code	Size	Waist (cm)	DVA:
FBS301259	Small	64.1 - 76.5	AR03
FBS301259M	Medium	76.5 - 89.2	AR03
FBS301259L	Large	89.2 - 104.5	AR03
FBS301259XL	X-Large	104.5 - 117.2	AR03
FBS301259XXL	XX-Large	117.2 - 129.9	AR03

Note: Measure around scapula under arm.

### DVA Contact Details

P 1300 888 052 | F 1300 787 052 | E [dva@aidacare.com.au](mailto:dva@aidacare.com.au)

**I ♥ ndis** For NDIS Item Code, refer to page: 508

**aidacare**  
HEALTHCARE EQUIPMENT



## Dale Abdominal Binder

- Single ply stretch loop elastic (latex-free)
- Velcro closure anywhere on belt for perfect fit
- Provides full, even pressure and aids abdominal muscle
- Colour: white
- Sizing: available in either 23cm (pictured) or 30cm widths, both in S, M and L sizes



## Dale Abdominal Lumbar Support

- Single ply stretch loop elastic (latex-free)
- Two removable aluminium supports
- Supports can be hand-shaped to hip curvature
- Velcro closure anywhere on belt for perfect fit
- Colour: white
- Sizing: available in either 23cm (pictured) or 30cm widths, both in S, M and L sizes

Code		Size	Waist/Hips (cm)	DVA:
23cm Width	30cm Width			
FBS301263	FBS301266	S	Up to 114	AR14
FBS301264	FBS301267	M	114 - 157	AR14
FBS301265	FBS301268	L	152 - 191	AR14

Note: Measure circumference of male waist/female hips.

Code		Size	Waist/Hips (cm)	DVA:
23cm Width	30cm Width			
FBS301270	FBS301273	S	Up to 114	AR08
FBS301271	FBS301274	M	114 - 157	AR08
FBS301272	FBS301275	L	152 - 191	AR08

Note: Measure circumference of male waist/female hips.



## Oppo 2263 Lumbar Sacral Support

- Built-in flexible stays provide additional support and prevent rolling
- Double layer design for adjustable compression
- Ventilated material for breath-ability and comfort
- Flexible stays provide stabilising support to the abdominal muscles
- Two flexible stays keep the belt smooth in the front for comfort when sitting
- Removable pad provides extra compression to the lower back

Code	Size	Waist (cm)	DVA:
FBS301276	Small	58.4 - 71.1	AR08
FBS301276M	Medium	71.1 - 83.8	AR08
FBS301276L	Large	83.8 - 96.5	AR08
FBS301276XL	X-Large	96.5 - 109.2	AR08
FBS301276XXL	XX-Large	109.2 - 121.9	AR08

Note: Measure around the waist.



## Oppo 2267 Lumbar Sacral Support - Light

- Extra stays provide effective back support
- Elastic reinforced straps for a perfect fit
- Breathable elastic mesh fabric ensures comfort
- May be worn under clothing and will not hinder daily activities

Code	Size	Waist (cm)	DVA:
FBS301277	Small	58.4 - 71.1	AR08
FBS301277M	Medium	71.1 - 83.8	AR08
FBS301277L	Large	83.8 - 96.5	AR08

Note: Measure around the waist.



## Oppo 2264 Lumbar Sacral Support - Foam

- Designed with straps crossing at the back and fastened in front
- Comfortable to wear and provides excellent support
- Four pliable support splints at the back for extra stability
- Breathable elastic/cotton and soft pile bonded to foam
- 22.8cm back depth

Code	Size	Waist (cm)	DVA:
FBS301279	Small	58.4 - 71.1	AR08
FBS301279M	Medium	71.1 - 83.8	AR08
FBS301279L	Large	83.8 - 96.5	AR08
FBS301279XL	X-Large	96.5 - 109.2	AR08
FBS301279XXL	XX-Large	109.2 - 121.9	AR08
FBS301279XXXL	XXX-Large	122 - 135	AR08

Note: Measure around the waist.



## Oppo 2061 Lumbar Sacral Belt

- Provides support and variable compression to the sacrum and sacroiliac region of the spine
- 50% cotton blend
- Used for therapeutic or prophylactic support
- Ideal for sports medicine

Code	Description	Size	Waist (cm)	DVA:
FBS301280	Oppo 2061 Lumbar Sacral Belt	One size	66 - 91.4	AR08

Note: Measure around the waist.

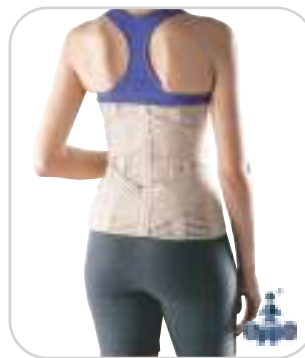

## Oppo 2065 Lumbar Sacral Support

- Designed with straps crossing at the back and fastened in front
- Comfortable to wear with 59% cotton content, and provides excellent support
- Four pliable support splints at the back for extra stability
- Choice of 2 back heights, 23cm and 30cm (pictured)

Code		Size	Waist (cm)	DVA:
23cm Width	30cm Width			
FBS301282	FBS301283	S	58.4 - 71.1	AR08
FBS301282M	FBS301283M	M	71.1 - 83.8	AR08
FBS301282L	FBS301283L	L	83.8 - 96.5	AR08
FBS301282XL	FBS301283XL	XL	96.5 - 109.2	AR08
FBS301282XXL	FBS301283XXL	XXL	109.2 - 121.9	AR08

Note: Measure around the waist.



## Oppo 2164 Lumbar Sacral Support - Multiband

- Designed with straps crossing at the back and fastened in front
- Comfortable to wear, and provides excellent support
- Four pliable support splints at the back for extra stability
- Breathable elastic/cotton blend and soft pile bonded to foam

Code	Size	Waist (cm)	DVA:
FBS301284	Small	58.4 - 71.1	AR08
FBS301284M	Medium	71.1 - 83.8	AR08
FBS301284L	Large	83.8 - 96.5	AR08
FBS301284XL	X-Large	96.5 - 109.2	AR08
FBS301284XXL	XX-Large	109.2 - 121.9	AR08

Note: Measure around the waist.



## Oppo 2261 Light Industrial Back Support

- Two extra stays on the back provide effective back support
- May be worn under clothing and will not hinder daily activities
- Breathable elastic/cotton mesh fabric ensures comfort
- Elastic reinforced straps for a custom fit
- Back height 25.4cm

Code	Size	Waist (cm)	DVA:
FBS301285	Small	58.4 - 71.1	AR08
FBS301285M	Medium	71.1 - 83.8	AR08
FBS301285L	Large	83.8 - 96.5	AR08
FBS301285XL	X-Large	96.5 - 109.2	AR08
FBS301285XXL	XX-Large	109.2 - 121.9	AR08

Note: Measure around the waist.



## Oppo 2169 Back Support/Shoulder Straps

- Helps prevent and relieve lower back pain
- Easy to apply and remove
- Shoulder straps enable user to affix when needed for lifting or bending
- May be used for both the lumbar and lumbosacral regions
- Four pliable support splints in the back for extra stability

Code	Size	Waist (cm)	DVA:
FBS301286	Small	73.7 - 83.8	AR08
FBS301286M	Medium	83.8 - 96.5	AR08
FBS301286L	Large	96.5 - 109.2	AR08
FBS301286XL	X-Large	109.2 - 124.5	AR08
FBS301286XXL	XX-Large	124.5 - 137.2	AR08

Note: Measure around the waist.



## Rehband 1069 Dosi EQX Straight Fit

- Classic back support for straighter figure
- 22cm width
- Four stabilising splints in back
- Adjustable cross-strap for individual support

Code	Size	Waist (cm)	DVA:
FBS301287	X-Small	56 - 64	AR08
FBS301287S	Small	64 - 72	AR08
FBS301287M	Medium	72 - 80	AR08
FBS301287L	Large	80 - 90	AR08
FBS301287XL	X-Large	90 - 100	AR08
FBS301287XXL	XX-Large	100 - 110	AR08

Note: Measure around the waist.

### DVA Contact Details

P 1300 888 052 | F 1300 787 052 | E [dva@aidocare.com.au](mailto:dva@aidocare.com.au)



For NDIS Item Code, refer to page: 508



## Rehband 1079 Dosi EQ SI Shaped Fit

- Classic back support for curved (female) figure
- 22cm width
- Four stabilising splints in back
- Adjustable cross-strap for individual support

Code	Size	Waist (cm)	DVA:
FBS301288	X-Small	56 - 64	AR08
FBS301288S	Small	64 - 72	AR08
FBS301288M	Medium	72 - 80	AR08
FBS301288L	Large	80 - 90	AR08
FBS301288XL	X-Large	90 - 100	AR08
FBS301288XXL	XX-Large	100 - 110	AR08

Note: Measure around the waist.



## Rehband 1070 Dosi EQ SI High Fit

- Classic back support, in high fit
- 30cm width
- Covers the lower back and half of the thoracic
- Four stabilising splints in back
- Adjustable cross-strap for individual support

Code	Size	Waist (cm)	DVA:
FBS301289	Small	64 - 72	AR08
FBS301289M	Medium	72 - 80	AR08
FBS301289L	Large	80 - 90	AR08
FBS301289XL	X-Large	90 - 100	AR08
FBS301289XXL	XX-Large	100 - 110	AR08

Note: Measure around the waist.



## BodyAssist 109 Sacro Cinch

- Cool, breathable lightweight lycra and elastic construction
- Incorporates two layers of closure, giving firm but comfortable support to the lower back
- Incorporates pliable support stays for extra stability

Code		Size	Waist (cm)	DVA:
Beige	Black			
FBS283620	FBS283662	X-Small	65 - 75	AR08
FBS283630	FBS283663	Small	75 - 85	AR08
FBS283640	FBS283664	Medium	85 - 95	AR08
FBS283650	FBS283665	Large	95 - 112	AR08
FBS283660	FBS283666	X-Large	112 - 130	AR08

Note: Measure around the waist.



## BodyAssist 105 Deluxe Sacro Cinch Support

- Elastic / lycra support with two layers of enclosure
- Front split design for perfect fit of waist/hips
- The upper side pull closure, wraps neatly around the waist, while the lower straps close perfectly over the hips

Code	Size	Waist (cm)	DVA:
FBS280529	Small	75 - 85	AR08
FBS280530	Medium	85 - 95	AR08
FBS280531	Large	95 - 105	AR08
FBS280532	X-Large	105 - 115	AR08

Note: Measure around the waist.



## Elastic Sacro Cinch Support

- Made of firm elastic with webbing cinch straps
- Reduces intradiscal pressure by increasing intra-abdominal pressure
- Velcro closure with cinch pull strap
- Two posterior metal stays, which need to be shaped at time of fitting
- Back length 25cm, front length 19cm
- Straighter male fit, and shaped female fit

Code		Size	Waist (cm)	DVA:
Male	Female			
FBS281610M	FBS281610	Small	76 - 86	AR08
FBS281620M	FBS281620	Medium	87 - 96	AR08
FBS281630M	FBS281630	Large	97 - 106	AR08
FBS281640M	FBS281640	X-Large	107 - 116	AR08
FBS281650M	FBS281650	XX-Large	117 - 126	AR08

Note: Measure around the waist.



## Elastic Sacro Cinch Support - Long Fit

- Made of firm elastic with webbing cinch straps
- Reduces intradiscal pressure by increasing intra-abdominal pressure
- Velcro closure with cinch pull strap
- Two posterior metal stays, which need to be shaped at time of fitting
- Back length 36cm, front length 22cm

Code	Size	Waist (cm)	DVA:
FBS301290	Small	76 - 86	AR08
FBS301290M	Medium	87 - 96	AR08
FBS301290L	Large	97 - 106	AR08
FBS301290XL	X-Large	107 - 116	AR08
FBS301290XXL	XX-Large	117 - 126	AR08

Note: Measure around the waist.



## Oppo 1063 Neoprene Back Belt - Univeoprene

- Provides maximum support to mid and lower back without restricting normal movement
- Three flexible stays on the back provide extra support
- Retains body heat for constant moist heat to lower back muscle group
- Hook and loop closure allows for a wide range of adjustable compression

Code	Description	Size	Waist (cm)	DVA:
FBS301293	Oppo 1063 Neoprene Back Belt - Univ (Beige)	One size	71.1 - 116.8	AR08

Note: Measure around the waist.



## Oppo 1064 Lumbar Support - Neoprene

- Provides support for lower back injuries
- Maximum support to mid and lower back without restricting normal movement
- Three flexible stays on the back provide extra support
- Hook and loop closure allows for a wide range of adjustable compression
- Two extra straps provide more support and stability
- 25cm width back shape provides extra support

Code	Size	Waist (cm)	DVA:
FBS301294	Small	61.0 - 78.7	AR08
FBS301294M	Medium	78.7 - 89.5	AR08
FBS301294L	Large	89.5 - 99.7	AR08
FBS301294XL	X-Large	99.7 - 110.5	AR08
FBS301294XXL	XX-Large	110.5 - 121.3	AR08

Note: Measure around the waist.



## McDavid A491 Waist Belt - Thermal

- Adjustable thermal waist belt that delivers various levels of compression with therapeutic warmth
- The shaped design and adjustable closures assures an optimum fit
- One size fits up to a 127cm or 50" waist

Code	Description	Size	DVA:
FBS285050	McDavid A491 Waist Belt - Thermal Black	Universal size	AR08

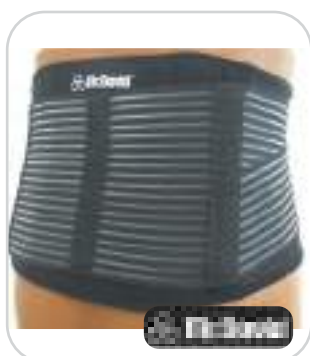

## McDavid A493 Sacro Cinch Support - Thermal

- Made of lightweight lycra, thermal rubber & orthopaedic elastic that delivers firm support
- Two layer closure. The first layer consists of heat retaining medical neoprene across the lower back, attached to lycra panels
- The outer straps deliver firm, powerful support when attached
- When closed the first layer delivers mild compression so the brace to be worn without effect
- 5 pliable support stays

Code	Size	Waist (cm)	DVA:
FBS283565	Small	60 - 80	AR08
FBS283570	Medium	67 - 105	AR08
FBS283580	Large	90 - 132	AR08

Note: Measure around the waist.





## BodyAssist 103 Lumbar Sacral Support – Neoprene

- Thermal neoprene delivers therapeutic warmth & protection to soft tissue
- Anatomically designed to fit perfectly
- Includes 4 rigid medical splints & 4 flexible spiral side stays
- 2 layers of closure
- Outer straps deliver firm, orthopaedic support
- Inner layer consists of thermal neoprene delivering minimal-to-mild compression

Code		Size	Waist (cm)	DVA:
Beige	Black			
FBS283600	FBS283595	Small - Medium	Up to 85	AR08
FBS283610	FBS283590	Large - X-Large	85 - 105	AR08

Note: Measure around the waist.



## Aspen TLSO - Thoraco Lumbar Sacral Bracing System

- The Aspen TLSO is a prefabricated, custom fitted orthosis
- Constructed of three rigid plastic shells including the rigid posterior panel and two rigid side panels
- Together with the padded chest panel, shoulder straps and torso control straps, the Aspen TLSO provides triplanar motion restriction
- Requiring several specific anatomical measurements and characterised by a structurally rigid layer of high density polyethylene that encircles the trunk, the Aspen TLSO is designed to be trimmed, bent, moulded or modified for use by a specific patient

Code		Size	Back Panel Ht. (cm)	Cut-Out Ht. (cm)	Circum. (cm)	DVA:
TLSO	Replacement Pads					
FBS301304	FBS301308	S/S - Short/Small	33	20	66 - 99	AR08
FBS301305	FBS301309	S/L - Short/Large	33	20	91 - 124	AR08
FBS301306	FBS301310	T/S - Tall/Small	41	25	81 - 119	AR08
FBS301307	FBS301311	T/L - Tall/Large	41	25	112 - 150	AR08



## Aspen LSO - Lumbar Sacral Bracing System

- The Aspen LSO is a prefabricated, custom fitted body jacket style orthosis made from high density polyethylene and rigid aluminum rods with a cotton-lined foam interface material

Code		Size	Back Panel Ht. (cm)	Cut-Out Ht. (cm)	Circum. (cm)	DVA:
LSO	Replacement Pads					
FBS301312	FBS301316	S/S - Short/Small	33	20	66 - 99	AR08
FBS301313	FBS301317	S/L - Short/Large	33	20	91 - 124	AR08
FBS301314	FBS301318	T/S - Tall/Small	41	25	81 - 119	AR08
FBS301315	FBS301319	T/L - Tall/Large	41	25	112 - 150	AR08



# Bracing & Supports - Arm & Elbow

**I ♥ ndis** For NDIS Item Code, refer to page: 508



## BodyAssist 95 Elbow Sleeve

- Provides a basic level of compression and orthopaedic support

Code	Description	Size	Elbow (cm)	DVA:
FBS284640	95 Elbow Sleeve	Small	20 - 25	AR03
FBS284650	95 Elbow Sleeve	Medium	25 - 28	AR03
FBS284660	95 Elbow Sleeve	Large	28 - 30	AR03
FBS284670	95 Elbow Sleeve	X-Large	30 +	AR03

Measure elbow circumference.



## McDavid A488 Thermal Elbow Wrap

- Multi-purpose elbow wrap provides warmth, firm compression and some protection
- Contoured and darted for a better fit
- Velcro closure ensures the best fit
- Fully adjustable

Code	Description	Colour	DVA:
FBS285040	A488 Thermal Elbow Wrap	Beige	AR03
FBS285038	A488 Thermal Elbow Wrap	Black	AR03

Measure elbow circumference.



## Oppo 1085 Elbow Sleeve

- Provides full support of elbow region in conjunction with reducing of the insertion of the extensor carpi radialis tendon
- Provides support and protection during activities which require extensive elbow use

Code	Description	Size	Elbow (cm)	DVA:
FBS301321	1085 Elbow Sleeve	Small	23.2 - 25	AR03
FBS3013212	1085 Elbow Sleeve	Medium	25.7 - 28	AR03
FBS3013213	1085 Elbow Sleeve	Large	28.3 - 30	AR03
FBS3013214	1085 Elbow Sleeve	X-Large	30.8 - 33	AR03

Measure elbow circumference.



## Oppo 2080 Elbow Sleeve

- Provides support and compression to the elbow joint without restricting flexibility
- Retains heat to relieve pain

Code	Description	Size	Elbow (cm)	DVA:
FBS301322	1085 Elbow Sleeve	Small	23.2 - 26	AR03
FBS3013222	1085 Elbow Sleeve	Medium	25.7 - 31.1	AR03
FBS3013223	1085 Elbow Sleeve	Large	31.1 - 37.5	AR03
FBS3013224	1085 Elbow Sleeve	X-Large	37.5 - 43.5	AR03

Measure elbow circumference.

### DVA Contact Details

P 1300 888 052 | F 1300 787 052 | E [dva@aidacare.com.au](mailto:dva@aidacare.com.au)

**I ♥ ndis** For NDIS Item Code, refer to page: 508

**aidacare**  
HEALTHCARE EQUIPMENT



## Rehband 7124 Hyper-Extension Elbow Brace

- Prevents hyper-extension of the elbow
- Constructed of warming neoprene
- Metal splints
- Cross-wise straps prevent hyper extension

Code	Description	Size	Forearm (cm)	DVA:
FBS301323	7124 Hyper-Ex Elbow Brace	X-Small	21 - 23	AR03
FBS301323S	7124 Hyper-Ex Elbow Brace	Small	23 - 25	AR03
FBS301323M	7124 Hyper-Ex Elbow Brace	Medium	25 - 28	AR03
FBS301323L	7124 Hyper-Ex Elbow Brace	Large	28 - 31	AR03
FBS301323XL	7124 Hyper-Ex Elbow Brace	X-Large	31 - 33	AR03

Measure forearm circumference.



## Rolyan DynaPro Flex Elbow

- Abnormal reflex arc therapy provided by the device assists in neuro-rehabilitation
- Axial hinge with legible goniometer facilitates fitting
- Elbow cuff extenders available
- New fabric reduces shear/friction
- Gel elbow pad included

Code	Description	Size	Upper Arm (cm)	Lower Arm (cm)	DVA:
FBS301324	DynaPro Flex Elbow	Small	20.3 - 25.4	12.7 - 20.3	AR03
FBS301324M	DynaPro Flex Elbow	Medium	22.8 - 29.2	19.0 - 25.4	AR03
FBS301324L	DynaPro Flex Elbow	Large	27.9 - 35.5	22.8 - 30.5	AR03

Upper Arm: circ (cm) around mid upper-arm  
Lower Arm: circumference (cm) around mid - lower arm.



## Rolyan Progressive Elbow/Knee Splint

- Provides soft, comfortable positioning with secure support while gently increasing the range of motion of elbow or knee
- 3-part Ezeform stay needs to be formed to patient and can be reformed as needed
- Latex free, hand wash, air dry

Code	Description	Size	(cm)	DVA:
FBS301325	Progressive Elbow/Knee Splint	X-Small	Up to 27	AR03
FBS301326	Progressive Elbow/Knee Splint	Small	27 - 38	AR03
FBS301327	Progressive Elbow/Knee Splint	Medium	39 - 44	AR03
FBS301328	Progressive Elbow/Knee Splint	Large	45 - 50	AR03
FBS301329	Progressive Elbow/Knee Splint	X-Large	51 - 56	AR03

Measure arm circ 5cm above elbow.  
Min 5cm clearance from axillary necessary.



## Oppo 1080 Tennis Elbow Brace

- Provides full support of elbow region in conjunction with reducing of the insertion of the extensor carpi radialis tendon
- Circular pad for extra pressure on the muscle in the arm or wrist
- Adjustable compressive strap reduces tension in wrist and finger extensors during gripping
- Tennis elbow, golfer's elbow

Code	Description	Size	Elbow (cm)	DVA:
FBS301335	1080 Tennis Elbow Brace	S	23.2 - 25.7	AR03
FBS3013352	1080 Tennis Elbow Brace	M	25.7 - 28.3	AR03
FBS3013353	1080 Tennis Elbow Brace	L	28.3 - 30.8	AR03
FBS3013354	1080 Tennis Elbow Brace	XL	30.8 - 33.3	AR03

Measure elbow circumference.



## Oppo 1086 Tennis Elbow Support

- Relieves pain from strained muscles in the forearm
- Circular pad for extra pressure on the muscle in the arm or wrist
- Adjustable hook and loop strap for greater tension if needed
- One size fits most
- Tennis elbow

Code	Description	Size	Elbow (cm)	DVA:
FBS301336	1086 Tennis Elbow Support	Universal	17.8 - 33	AR03

Measure elbow circumference.



## Oppo 1486 Tennis Elbow Support With Silicone Pad

- Specially shaped silicone inserts surrounding the epicondyles and the adjoining radius
- Oedema and haematoma are quickly reabsorbed
- Rapidly improves the joint function
- Relieves the strain on the periarticular tissues and compresses the soft tissue area
- One size fits most

Code	Description	Size	Forearm (cm)	DVA:
FBS301337	1486 Tennis Elbow Support with Silicone Pad	Universal	17.8 - 33	AR03

Measure forearm circumference.



## Oppo 3086 Tennis Elbow Brace

- Detachable inner pad may be removed for cleaning
- Raised soft foam may be positioned to reduce muscle loading
- Clasp plastic provides pressure evenly on musculature around the elbow
- Adjustable hook and loop closure for a comfortable fit and stabilisation during daily activities

Code	Description	Size	Elbow (cm)	DVA:
FBS301338	3086 Tennis Elbow Brace	S	24.1 - 25.4	AR03
FBS3013382	3086 Tennis Elbow Brace	M	25.4 - 27.3	AR03
FBS3013383	3086 Tennis Elbow Brace	L	27.3 - 29.8	AR03
FBS3013384	3086 Tennis Elbow Brace	XL	27.3 - 29.8	AR03

Measure elbow circumference.



## Rehband 4801 Epiflex Tennis Elbow Brace

- Neoprene/elastic elbow support provides relief of the tendon insertion
- Easy fastening buckles allow adjustment of compression

Code	Description	Size	Elbow (cm)	DVA:
FBS301339	4801 Epiflex Tennis Elbow Brace	S	24 - 25	AR03
FBS301339M	4801 Epiflex Tennis Elbow Brace	M	26 - 27	AR03
FBS301339L	4801 Epiflex Tennis Elbow Brace	L	28 - 30	AR03
FBS301339XL	4801 Epiflex Tennis Elbow Brace	XL	31 - 33	AR03

Measure elbow circumference.



## Rehband 7122 Epi Ulna Tennis Elbow Support

- Warming elbow support which provides relief of the tendon insertion
- Warming neoprene
- Adjustable width for the arm

Code	Description	Size	Elbow (cm)	DVA:
FBS301340	7122 Epi Ulna Tennis Elbow Support	XS	21 - 23	AR03
FBS301340S	7122 Epi Ulna Tennis Elbow Support	S	23 - 25	AR03
FBS301340M	7122 Epi Ulna Tennis Elbow Support	M	25 - 28	AR03
FBS301340L	7122 Epi Ulna Tennis Elbow Support	L	28 - 31	AR03
FBS301340XL	7122 Epi Ulna Tennis Elbow Support	XL	31 - 33	AR03
FBS301340XXL	7122 Epi Ulna Tennis Elbow Support	XXL	33 - 36	AR03

Measure elbow circumference.



## BodyAssist 970 Tennis Elbow Band

- Rigid, non - stretch strap
- Heavy duty D - loop closure for snug fit
- Incorporates pressure pad
- One size fits all

Code	Description	Size	DVA:
FBS280880	970 Tennis Elbow Band	Universal	AR03

Measure elbow circumference.



## McDavid A486 Thermal Tennis Elbow Strap

- Applies pressure over the tendons
- Rigid velcro cinch-strap closes neatly over a neoprene inner wrap
- Shaped design with adjustable touch tape closure

Code	Description	Size	DVA:
FBS285030	A486 Thermal Tennis Elbow Strap	Universal	AR03

Measure elbow circumference.



## McDavid A485 Thermal Tennis Elbow Support

- Heavy-duty neoprene sleeve with rigid cinch strap
- Applies pressure over the tendon
- Delivers therapeutic heat and protection to the elbow joint

Code	Description	Size	Elbow (cm)	DVA:
FBS285018	A485 Thermal Tennis Elbow Support	S	20 - 24	AR03
FBS285019	A485 Thermal Tennis Elbow Support	M	24 - 28	AR03
FBS285020	A485 Thermal Tennis Elbow Support	L	28 - 30.5	AR03
FBS285021	A485 Thermal Tennis Elbow Support	XL	30.5 - 35.5	AR03

Measure elbow circumference.



## Rolyan Takeoff Forearm Band

- Removable gel pad helps dampen vibration at the elbow
- Rinse after use to extend band life
- Latex free
- TensoWrap™ forearm band changes force's direction to bypass the injured portion of the muscle/tendon unit

Code	Description	Size	DVA:
FBS301341	Takeoff Forearm Band	Universal	AR03



## Oppo 3089 Arm Sling

- Supports the arm and carries the weight across the back and shoulder
- Universal design fits right or left arm
- Adjustable slide buckle for proper height adjustment
- Comfortable lightweight material

Code	Description	Size	Forearm (cm)	DVA:
FBS301342	3089 Arm Sling	S	25.4 - 29.2	AR03
FBS3013422	3089 Arm Sling	M	29.2 - 36.8	AR03
FBS3013423	3089 Arm Sling	L	36.8 - 43.2	AR03
FBS3013424	3089 Arm Sling	XL	43.2 - 48.3	AR03

Measure the length of forearm.



## Oppo 3289 Mesh Arm Sling

- Offers immobilisation and support for mild sprains/strains of the shoulder area
- Netting material for greater comfort, particularly for long-term use
- Adjustable padded straps for height adjustment

Code	Description	Size	Forearm (cm)	DVA:
FBS301347	3289 Mesh Arm Sling	S	23.5 - 25.4	AR03
FBS3013472	3289 Mesh Arm Sling	M	25.4 - 30.5	AR03
FBS3013473	3289 Mesh Arm Sling	L	30.5 - 35.6	AR03
FBS3013474	3289 Mesh Arm Sling	XL	35.5 - 40.6	AR03

Measure the length of forearm.



## Oppo 3189 Arm Sling/Immobiliser

- Helps immobilise and support the arm
- Comfortably supports a sprained or broken arm or for post-surgical support
- Extra strap offers more stabilisation

Code	Description	Size	Forearm (cm)	DVA:
FBS301348	3189 Arm Sling/Immobiliser	S	25.4 - 29.2	AR03
FBS3013482	3189 Arm Sling/Immobiliser	M	29.2 - 36.8	AR03
FBS3013483	3189 Arm Sling/Immobiliser	L	36.8 - 43.2	AR03
FBS3013484	3189 Arm Sling/Immobiliser	XL	43.2 - 48.3	AR03



## Rolyan Deluxe Shoulder Immobiliser

- Shoulder pad for added comfort
- Extra-deep pocket improves arm positioning
- Waist strap limits shoulder movement

Code	Size	Forearm (cm)	DVA:
FBS301349	X-Small	Up to 28	AR03
FBS301350	Small	28	AR03
FBS301351	Medium	36	AR03
FBS301352	Large	43	AR03
FBS301353	X-Large	51	AR03

Measure the length of the forearm from the elbow to the knuckles.



## Collarcare Padded Arm Sling/Immobiliser

- Designed to provide support to the clavicle area or for full shoulder immobilisation
- The padded fabric provides superior body conformity and weight-bearing comfort
- Suitable for CVA patients
- 'D' buckle design allows adjustment for comfort
- Soft padded arm pouch can be folded to fit

Code	Description	Size	DVA:
FBS301360	Padded Arm Sling/Immobiliser	Child	AR03
FBS301359	Padded Arm Sling/Immobiliser	Adult	AR03



## Collarcare Light Arm Sling/Immobiliser

- Designed to provide support to the clavicle area or for full shoulder immobilisation
- Suitable for CVA patients
- 'O' buckle design allows adjustment for comfort
- Circumferential waist strap allowing arm to be fixed to the body

Code	Description	Size	(cm)	DVA:
FBS301355	Light Arm Sling/Immobiliser	S	16 x 32	AR03
FBS301356	Light Arm Sling/Immobiliser	M	19 x 39	AR03
FBS301357	Light Arm Sling/Immobiliser	L	21 x 44	AR03
FBS301358	Light Arm Sling/Immobiliser	XL	24 x 50	AR03

Sizing: depth x forearm length.



## Rolyan Shoulder Support Abduction Sling

- Shoulder abduction positioning with support
- Pillow portion rests on waist to support arm weight
- Y-tabs provide easy strap length adjustability
- Snap-open front panel facilitates putting support on and taking it off
- Sling positioning allows air exchange at axilla

Code	Description	Size	Forearm (cm)	DVA:
FBS301361	Shoulder Support Abduction Sling	S	28	AR03
FBS301362	Shoulder Support Abduction Sling	M	36	AR03
FBS301363	Shoulder Support Abduction Sling	L	43	AR03

Measure the length of the forearm from the elbow to the knuckles.



## Rolyan Figure Of 8 Sling

- Soft strapping system distributes pressure
- Supportive for orthopaedic and neurological conditions
- Hook and loop construction provides wide adjustability

Code	Description	Size	Forearm (cm)	DVA:
FBS301364	Figure-of-8 Sling	S/M	Up to 34.5	AR03
FBS301365	Figure-of-8 Sling	L/XL	Up to 37.5	AR03

Measure elbow crease to base of the index finger.



## Rolyan CVA Sling

- Machine washable
- Latex free

Code	Description	Size	DVA:
FBS301366	CVA Sling	Universal	AR03

# Bracing & Supports - Wrist & Hand

**I ♥ ndis** For NDIS Item Code, refer to page: 508



## Oppo 2083 Wrist Wrap w/Thumb Loop

- Universal design fits left and right hand
- Provides comfortable compression and support

Code	Description	Size	Wrist (cm)	DVA:
FBS301370	Oppo 2083 Wrist Wrap w/Thumb Loop	Universal Size	14 - 23	AR03

Measure wrist circumference.



## Oppo 2481 Wrist Wrap w/Silicone

- Provides localised support and compression, and avoids unnecessary compression to areas where it is not required
- Tension is fully adjustable to provide from light support to total compression
- Cohesive fabric, causing no pain or irritation to the skin whilst in use, comfortable to wear and painless to remove
- 7.5 cm width
- Secure the hook closure

Code	Description	DVA:
FBS301371	Oppo 2481 Wrist Wrap w/Silicone	AR03



## Oppo 1081 Wrist Wrap

- Helps relieve pain through pressure on injured wrists
- Adjustable hook and loop strap ensures comfortable fit and stabilisation during activities
- Provides firm support around weak or strained area
- Fits wrist circumference 12 - 23 cm

Code	Description	Size	DVA:
FBS301367	Oppo 1081 Wrist Wrap	Universal Size	AR03

### General Enquiries

P 1300 133 120 | E [sales@aidacare.com.au](mailto:sales@aidacare.com.au) | W [www.aidacare.com.au](http://www.aidacare.com.au)



## Oppo 1083 Wrist Wrap w/Thumb Loop

- Provides comfortable compression and support for weak or stressed wrists
- Helps treatment and prevention of injury
- Retains warmth, which may aid and speed up recovery period
- Fits wrist circumference 12 - 23cm

Code	Description	Size	DVA:
FBS301368	Oppo 1083 Wrist Wrap W/Thumb Loop	Universal Size	AR03



## McDavid A451 Thermal Wrist Wrap

- Multi-purpose wrist wrap providing therapeutic warmth, firm compression and some protection
- Thumb hole, fully adjustable
- Velcro closure
- Colour black
- One size fits all
- Fits wrist circumference 12 - 23cm

Code	Description	Size	DVA:
FBS284970	McDavid A451 Thermal Wrist Wrap	Universal Size	AR03



## BodyAssist 250 Deluxe Wrist Support

- Compressive wrist brace
- Adjustable thumb strap

Code	Description	Size	Wrist (cm)	DVA:
FBS283910	BodyAssist 250 Deluxe Wrist Support	S	Up to 16.5	AR03
FBS283920	BodyAssist 250 Deluxe Wrist Support	M	16.5 - 19	AR03
FBS283930	BodyAssist 250 Deluxe Wrist Support	L	19 +	AR03

Measure wrist circumference.



## Oppo 2081 Wrist Wrap

- Helps relieve pain through pressure of injured wrists
- Elastic hook and loop strap insures comfortable fit and stabilisation during activities
- Provides firm support around weak or strained area
- Fits wrist circumference 12 - 23cm

Code	Description	Size	DVA:
FBS301369	Oppo 2081 Wrist Wrap	Universal Size	AR03



## Oppo 2288 Wrist Splint With Strap

- Semi-rigid thumb spica portion is contoured to provide support, immobilisation and thumb abduction
- Provides wrist stability with moderate motion restriction
- An elastic wrist strap gives greater wrist stability
- Aluminum stay can easily be reversed to fit right or left hand

Code	Description	Size	Wrist (cm)	DVA:
FBS301373	Oppo 2288 Wrist Splint with Strap	S	14 - 15.9	AR03
FBS3013732	Oppo 2288 Wrist Splint with Strap	M	15.9 - 18.4	AR03
FBS3013733	Oppo 2288 Wrist Splint with Strap	L	18.4 - 21	AR03
FBS3013734	Oppo 2288 Wrist Splint with Strap	XL	21 - 23.5	AR03

Measure wrist circumference.





## Oppo 3082 Wrist Support With D-Rings

- Hook and loop closures ensure proper fit and easy application
- Removable aluminum splint helps relieve pain
- Specify left or right when ordering

Code		Description	Size	Wrist (cm)	DVA:
Left	Right				
FBS301374L1	FBS301374	Oppo 3082 Wrist Support with D-Rings	S	14 - 15.9	AR03
FBS301374L2	FBS301374R2	Oppo 3082 Wrist Support with D-Rings	M	15.9 - 18.4	AR03
FBS301374L3	FBS301374R3	Oppo 3082 Wrist Splint with D-Rings	L	18.4 - 21	AR03
FBS301374L4	FBS301374R4	Oppo 3082 Wrist Splint with D-Rings	XL	21 - 23.5	AR03

Measure wrist circumference.



## Oppo 2182 Wrist Splint With Strap

- An elastic wrist strap gives greater wrist stability
- Reversible aluminum splint may be easily be relocated to fit right or left hand

Code	Description	Size	Wrist (cm)	DVA:
FBS301375	Oppo 2182 Wrist Splint with Strap	S	14 - 15.9	AR03
FBS3013752	Oppo 2182 Wrist Splint with Strap	M	15.9 - 18.4	AR03
FBS3013753	Oppo 2182 Wrist Splint with Strap	L	18.4 - 21	AR03
FBS3013754	Oppo 2182 Wrist Splint with Strap	XL	21 - 23.5	AR03

Measure wrist circumference.



## BodyAssist 260 Deluxe Wrist/Hand Brace

- Contoured support for weak, injured wrists
- Pliable rigid splint to minimise wrist movement

Code	Description	Size	Wrist (cm)	DVA:
FBS283940	BodyAssist 260 Deluxe Wrist/Hand Brace	S	Up to 16.5	AR03
FBS283950	BodyAssist 260 Deluxe Wrist/Hand Brace	M	16.5 - 19	AR03
FBS283960	BodyAssist 260 Deluxe Wrist/Hand Brace	L	19 - 21.5	AR03
FBS283970	BodyAssist 260 Deluxe Wrist/Hand Brace	XL	22 +	AR03

Measure wrist circumference.



## McDavid A454 Thermal Carpal Tunnel Wrist Splint

- Contoured thermal neoprene for weak injured wrists
- Includes a plantar splint to minimise wrist movement
- Specify left or right
- One size fits all

Code		Description	DVA:
Left	Right		
FBS285000	FBS285010	McDavid A454 Thermal Carpal Tunnel Wrist Splint	AR03



## Rehband 4024 Manu Rheuma Flex Wrist

- Wrist support made of soft, skin caring and breathable material
- Supports the wrist through a flexible palmar splint
- Velcro closure simplifies applying the support for rheumatic patients
- A soft and pre-shaped plastic splint provides light support
- Straight model to fit the arthritic hand

Code		Size	Wrist (cm)	DVA:
Left	Right			
FBS301377LXS	FBS301377	XS	14 - 15	AR03
FBS301377LS	FBS301377RS	S	15 - 16.5	AR03
FBS301377LM	FBS301377RM	M	16.5 - 18	AR03
FBS301377LL	FBS301377RL	L	18 - 19.5	AR03
FBS301377LXL	FBS301377RXL	XL	19.5 - 21	AR03
FBS301377LXXL	FBS301377RXXL	XXL	21 - 22.5	AR03

Measure wrist circumference.



## Rehband 4055 Manu Comfort T Wrist

- Stabilising wrist brace
- Easily applied
- Excellent comfort through the temperature regulating features of ComforTemp
- Includes plastic and steel splints
- 3 cm shorter than Rehband 4058
- Specify left or right when ordering

Code		Size	Wrist (cm)	DVA:
Left	Right			
FBS301378L1	FBS301378	XS - S	13 - 16	AR03
FBS301378L2	FBS301378R2	M - L	16 - 19	AR03
FBS301378L3	FBS301378R3	XL - XXL	19 - 23	AR03

Measure wrist circumference.



## Rehband 4074 Diagonal Lycra Short Wrist

- A thumb support with splint to stabilise the CMC and MCP joints of the thumb
- The material offers optimal fit and comfort
- Pain relieving and unloading effects
- Specify left or right when ordering

Code		Size	Wrist (cm)	DVA:
Left	Right			
FBS301382LXS	FBS301382	XS	13 - 14	AR03
FBS301382LS	FBS301382RS	S	14 - 16	AR03
FBS301382LM	FBS301382RM	M	16 - 18	AR03
FBS301382LL	FBS301382RL	L	18 - 20	AR03
FBS301382LXL	FBS301382RXL	XL	20 - 22	AR03

Measure wrist circumference.



## Rehband 4088 Wrist

- Provides exceptional stability while immobilising the wrist
- Made of thermoprene material for optimal comfort
- A firm wrist stay supports the palmar side, while a dorsal pocket holds a thermoplastic insert
- Both the stay and insert can be heat-moulded
- Specify left or right when ordering

Code		Size	Wrist (cm)	DVA:
Left	Right			
FBS301383LS	FBS301383	S	14 - 16	AR03
FBS301383LM	FBS301383RM	M	16 - 18	AR03
FBS301383LL	FBS301383RL	L	18 - 20	AR03
FBS301383LXL	FBS301383RXL	XL	20 - 22	AR03

Measure wrist circumference.



## Rehband 4142 Manu 3D

- High quality 3 tab wrist brace with flexion stay
- Provides a light support to the basal thumb joint
- Specify left or right when ordering

Code		Size	Wrist (cm)	DVA:
Left	Right			
FBS301384LXS	FBS301384	XS	14.5 - 15.5	AR03
FBS301384LS	FBS301384RS	S	15.5 - 16	AR03
FBS301384LM	FBS301384RM	M	16 - 17	AR03
FBS301384LL	FBS301384RL	L	17 - 18	AR03
FBS301384LXL	FBS301384RXL	XL	18 - 19	AR03
FBS301384LXXL	FBS301384RXXL	XXL	19 - 20	AR03

Measure wrist circumference.



## Rehband 4143 Manu 3D Basis

- High quality 3 tab wrist brace with flexion stay
- Allows free thumb motion
- Six sizes left and right

Code		Size	Wrist (cm)	DVA:
Left	Right			
FBS301385LXS	FBS301385	XS	14.5 - 15.5	AR03
FBS301385LS	FBS301385RS	S	15.5 - 16	AR03
FBS301385LM	FBS301385RM	M	16 - 17	AR03
FBS301385LL	FBS301385RL	L	17 - 18	AR03
FBS301385LXL	FBS301385RXL	XL	18 - 19	AR03
FBS301385LXXL	FBS301385RXXL	XXL	19 - 20	AR03

Measure wrist circumference.



## Rehband 4058 Manu Comfort T Stable Wrist

- Extra stabilising wrist brace
- Easily applied
- Excellent comfort through the temperature regulating features of ComforTemp
- Includes plastic and steel splints
- 3 cm longer than Rehband 4055
- Specify left or right when ordering

Code		Size	Wrist (cm)	DVA:
Left	Right			
FBS301379L1	FBS301379	XS - S	13 - 16	AR03
FBS301379L2	FBS301379R2	M - L	16 - 19	AR03
FBS301379L3	FBS301379R3	XL - XXL	19 - 23	AR03

Measure wrist circumference.



## Rolyan D-Ring Wrist Long Fit - Firm

- Volar and dorsal stays for extra wrist support
- Prevents unwanted flexion or extension, yet allows unobstructed motion of the fingers and thumb
- Non-elastic circumferential design for easy application and for firm, evenly distributed pressure without restricting circulation
- D-ring closure system for simple application, removal and customised tension control
- Double layer of stockinette under closures cushions straps

Code		Size	Wrist (cm)	DVA:
Left	Right			
FBS301390	FBS301386	XS	Up to 14.6	AR03
FBS301391	FBS301387	S	14.6 - 16.5	AR03
FBS301392	FBS301388	M	16.6 - 19.1	AR03
FBS301393	FBS301389	L	16.6 - 19.1	AR03

Measure wrist circumference.



## Rolyan D-Ring Wrist Brace

- Non-elastic construction does not restrict circulation
- Circumferential design holds the brace in position during application
- D-ring closures provide tension control to adjust amount of support
- Double layer of cotton stockinette under closures cushions straps
- Forearm length is proportional to brace size
- Removable, adjustable aluminium support bar
- Splints available in regular and long length
- Regular length splint is also available with a larger thumb hole, which accommodates larger thumbs and fluctuating oedema.
- Fabricated from a polyester/cotton fabric laminated to 1cm foam

Code		Size	Wrist (cm)	Length (cm)	DVA:
Left	Right				
<b>Style - Regular</b>					
FBS301394LXS	FBS301394	XS	Up to 14.6	15.9	AR03
FBS301394LS	FBS301394RS	S	14.6 - 16.5	16.5	AR03
FBS301394LM	FBS301394RM	M	16.6 - 19.1	17.8	AR03
FBS301394LL	FBS301394RL	L	19.2 - 21.6	19	AR03
FBS301394LXL	FBS301394RXL	XL	Over 21.6	19.7	AR03
<b>Style - Regular - Large Thumb</b>					
FBS301395LXS	FBS301395	XS	Up to 14.6	15.9	AR03
FBS301395LS	FBS301395RS	S	14.6 - 16.5	16.5	AR03
FBS301395LM	FBS301395RM	M	16.6 - 19.1	17.8	AR03
FBS301395LL	FBS301395RL	L	19.2 - 21.6	19	AR03
FBS301395LXL	FBS301395RXL	XL	Over 21.6	19.7	AR03
<b>Style - Long</b>					
FBS301396LXS	FBS301396	XS	Up to 14.6	21	AR03
FBS301396LS	FBS301396RS	S	14.6 - 16.5	21.6	AR03
FBS301396LM	FBS301396RM	M	16.6 - 19.1	22.2	AR03
FBS301396LL	FBS301396RL	L	19.2 - 21.6	22.6	AR03
FBS301396LXL	FBS301396RXL	XL	Over 21.6	23.2	AR03

Measure wrist circumference.



## Rolyan Take Off Universal Wrist Splint

- Semi-rigid foam support with plastic stay
- Soft, breathable Fabrifoam material provides friction to keep splint from migrating and helps remove moisture
- One size fits most adults

Code		Size	DVA:
Left	Right		
FBS301405	FBS301406	Universal	AR03



## Rolyan Alignrite Wrist Support w/Wrist Strap

- Provides excellent support for the wrist while allowing fingers and thumb free movement
- Woven cotton-coated rubber fabric has open weave for ventilation
- Wrap - around wrist strap provides extra support
- Hand or machine wash, air dry
- Latex free

Code		Size	Wrist (cm)	DVA:
Left	Right			
FBS301407	FBS301408	XS	11.4 - 14.0	AR03
FBS301409	FBS301410	S	14.0 - 16.5	AR03
FBS301411	FBS301412	M	16.6 - 18.4	AR03
FBS301413	FBS301414	L	18.5 - 20.3	AR03
FBS301415	FBS301416	XL	20.4 - 22.2	AR03

Measure wrist circumference.



## Rolyan Wrist Splint

- Unlike neoprene or perforated neoprene, breathoprene allows air through, and wicks perspiration away from the skin for enhanced comfort and compliance
- The two-way stretch 3.2 mm thick, soft material provides compression and a perfect fit
- Removable metal dorsal and palmar stays and wrist D-ring strap for added support
- Wraparound design
- Latex free

Code		Size	Wrist (cm)	DVA:
Left	Right			
FBS301417	FBS301418	S	14 - 16.5	AR03
FBS301419	FBS301420	M	16.6 - 18.4	AR03
FBS301421	FBS301422	L	18.5 - 20.3	AR03
FBS301423	FBS301424	XL	20.4 - 22.2	AR03

Measure wrist circumference.



## Oppo 1289 Wrist/Thumb Support w/Strap

- Three removable metal splints in thumb area for improved stability
- Additional strap for stabilisation during activities
- Supports the wrist and thumb, leaving the palm free
- Ideal for sprains of thumb, ligament support, and minor fractures of the thumb

Code	Description	Size	Wrist (cm)	DVA:
FBS301425	Oppo 1289 Wrist/Thumb Support W/Strap	S	13 - 15.2	AR03
FBS3014252	Oppo 1289 Wrist/Thumb Support W/Strap	M	15.2 - 17.2	AR03
FBS3014253	Oppo 1289 Wrist/Thumb Support W/Strap	L	17.2 - 19.1	AR03
FBS3014254	Oppo 1289 Wrist/Thumb Support W/Strap	XL	19.1 - 21	AR03

Measure wrist circumference.



## Oppo 2184 Wrist/Thumb Sleeve

- Pull-on sleeve in four-way stretch tubular elastic
- Not splinted, light compression
- Universal design fits left and right hand

Code	Description	Size	Wrist (cm)	DVA:
FBS301426	Oppo 2184 Wrist/Thumb Sleeve	S	14 - 15.9	AR03
FBS3014262	Oppo 2184 Wrist/Thumb Sleeve	M	15.9 - 18.4	AR03
FBS3014263	Oppo 2184 Wrist/Thumb Sleeve	L	18.4 - 21	AR03
FBS3014264	Oppo 2184 Wrist/Thumb Sleeve	XL	21 - 23.5	AR03

Measure wrist circumference.



## Oppo 3182 Wrist Support With Thumb

- Wraparound design and hook and loop straps for easy fit
- Supports and limits the motion of the thumb and wrist joint
- Elastic fabric provides compression
- Elastic hook and loop strap may be used to limit wrist motion
- Specify left or right

Code		Description	Size	Wrist (cm)	DVA:
Left	Right				
FBS301427L1	FBS301427	Oppo 3182 Wrist Support with Thumb	S	14 - 15.9	AR03
FBS301427L2	FBS301427R2	Oppo 3182 Wrist Support with Thumb	M	15.9 - 18.4	AR03
FBS301427L3	FBS301427R3	Oppo 3182 Wrist Support with Thumb	L	18.4 - 21	AR03
FBS301427L4	FBS301427R4	Oppo 3182 Wrist Support with Thumb	XL	21 - 23.5	AR03

Measure wrist circumference.



## Oppo 1089 Wrist Thumb Support

- Thumb orthosis especially suitable for rheumatics
- Relieves pain and stabilises CMC joint
- Reinforced metal stick stabilises thumb
- Adjustable hook and loop fasteners insure comfortable fit and stabilisation during activities
- Thermal wrist support for tenosynovitis, carpal tunnel syndrome and general wrist support

Code	Description	Size	Wrist (cm)	DVA:
FBS301428	Oppo 1089 Wrist Thumb Support	S	14 - 15.9	AR03
FBS3014282	Oppo 1089 Wrist Thumb Support	M	15.9 - 18.4	AR03
FBS3014283	Oppo 1089 Wrist Thumb Support	L	18.4 - 21	AR03
FBS3014284	Oppo 1089 Wrist Thumb Support	XL	21 - 23.5	AR03

Measure wrist circumference.



## Oppo 1188 Mouldable Wrist/Thumb Support

- Relieves pain
- Thermoplastic support stabilises thumb
- Thermoplastic insert may be removed as healing progresses
- Available in 3 lengths: 14 cm, 16.5 cm and 21 cm

Code			Size	Wrist (cm)	DVA:
Short (14cm)	Medium (16.5cm)	Long (21cm)			
FBS301429	FBS3014296-1	FBS3014298-1	S	14 - 15.9	AR03
FBS3014295-2	FBS3014296-2	FBS3014298-2	M	15.9 - 18.4	AR03
FBS3014295-3	FBS3014296-3	FBS3014298-3	L	18.4 - 21	AR03
FBS3014295-4	FBS3014296-4	FBS3014298-4	XL	21 - 23.5	AR03
FBS3014295-5	FBS3014296-5	FBS3014298-5	XXL	23.5 - 26	AR03

Measure wrist circumference.



## Rehband 4025 Rheuma Wrist & Thumb Support

- Wrist/thumb support made of soft and breathable material
- Supports the wrist through a flexible palmar splint
- Velcro closure simplifies applying the support for rheumatic patients
- Straight model to fit the arthritic hand
- The placement of the velcro is chosen to avoid any pressure on caput ulnae

Code		Size	Wrist (cm)	DVA:
Left	Right			
FBS301430LXS	FBS301430	XS	14 - 15	AR03
FBS301430LS	FBS301430RS	S	15 - 16.5	AR03
FBS301430LM	FBS301430RM	M	16.5 - 18	AR03
FBS301430LL	FBS301430RL	L	18 - 19.5	AR03
FBS301430LXL	FBS301430RXL	XL	19.5 - 21	AR03
FBS301430LXXL	FBS301430RXXL	XXL	21 - 22.5	AR03

Measure wrist circumference.



## Rehband 4146 Manu 3D Pollex

- High quality 3 tab wrist brace with flexion stay
- Aluminium thumb stay
- Six sizes left and right

Code		Size	Wrist (cm)	DVA:
Left	Right			
FBS301431LXS	FBS301431	XS	14 - 15	AR03
FBS301431LS	FBS301431RS	S	15.5 - 16	AR03
FBS301431LM	FBS301431RM	M	16 - 17	AR03
FBS301431LL	FBS301431RL	L	17 - 18	AR03
FBS301431LXL	FBS301431RXL	XL	18 - 19	AR03
FBS301431LXXL	FBS301431RXXL	XXL	19 - 20	AR03

Measure wrist circumference.



## Rolyan D-Ring Wrist/Thumb Spica

- Made of cotton/polyester fabric lined with cotton stockinette
- Circumferential design with D-ring closures makes the brace easy to put on and comfortable to wear
- Two metal stays support wrist and thumb
- Specify left or right

Code		Size	Wrist (cm)	DVA:
Left	Right			
FBS282670	FBS282680	XS	Up to 14.6	AR03
FBS282690	FBS282700	S	14.6 - 16.5	AR03
FBS282710	FBS282715	M	16.6 - 19.1	AR03
FBS282720	FBS282730	L	19.2 - 21.6	AR03
FBS282725	FBS282731	XL	Over 21.6	AR03

Measure wrist circumference.



## Rolyan D-Ring Wrist/Thumb Spica - Thermal

- Made from a neoprene blend with a Trioxon lining
- Maintains body heat, yet allows skin to breathe
- Circumferential design with D-ring closures makes the brace easy to put on and comfortable to wear
- Adjust the amount of wrist extension with aluminium stay

Code		Size	Wrist (cm)	DVA:
Left	Right			
FBS280191	FBS280196	XS	U to 14.6	AR03
FBS280192	FBS280197	S	14.6 - 16.5	AR03
FBS280193	FBS280199	L	19.2 - 21.6	AR03
FBS280194	FBS280201	XL	Over 21.6	AR03

Measure wrist circumference.



## BodyAssist N29 Thumb Abduction Splint

- Minimises thumb movement while leaving palm and fingers free

Code	Description	Size	Wrist (cm)	DVA:
FBS301432	Body Assist N29 Thumb Abduction Splint	S/M	Up to 19	AR03
FBS3014323	Body Assist N29 Thumb Abduction Splint	L/XL	19 +	AR03

Measure wrist circumference.



## BodyAssist 280 Thumb Splint

- Designed to minimise wrist and thumb movement
- Supplied with two interchangeable splints - a rigid splint, and pliable metal stay

Code	Description	Size	Wrist (cm)	DVA:
FBS280680	BodyAssist 280 Thumb Splint	S	Up to 16.5	AR03
FBS2806802	BodyAssist 280 Thumb Splint	M	16.5 - 19	AR03
FBS2806803	BodyAssist 280 Thumb Splint	L	19 - 21.5	AR03
FBS2806804	BodyAssist 280 Thumb Splint	XL	22+	AR03

Measure wrist circumference.



## Rehband 4064 EQ Diagonal Lycra Thumb

- Thumb support made of durable lycra
- Features a splint to stabilise the CMC and MCP joints of the thumb
- Elasticity of the material is used diagonally for optimal fit and support

Code		Size	Wrist (cm)	DVA:
Left	Right			
FBS301433LXS	FBS301433	XS	13 - 14	AR03
FBS301433LS	FBS301433RS	S	14 - 16	AR03
FBS301433LM	FBS301433RM	M	16 - 18	AR03
FBS301433LL	FBS301433RL	L	18 - 20	AR03
FBS301433LXL	FBS301433RXL	XL	20 - 22	AR03

Measure wrist circumference.



## Rehband Thumboform Splint

- The thumboform thumb support comes with a heat-mouldable insert
- This splint stabilises the CMC and MCP joint of the thumb
- Available in short, long and Xlong styles

Code - Short		Code - Long		Code - XLong		Size	Wrist (cm)	DVA:
Left	Right	Left	Right	Left	Right			
FBS301434LS	FBS301434	FBS301435LS	FBS301435	FBS301436LS	FBS301436	S	14 - 16	AR03
FBS301434LM	FBS301434RM	FBS301435LM	FBS301435RM	FBS301436LM	FBS301436RM	M	16 - 18	AR03
FBS301434LL	FBS301434RL	FBS301435LL	FBS301435RL	FBS301436LL	FBS301436RL	L	18 - 20	AR03

Measure wrist circumference.



## Rolyan Collum CMC Thumb Brace

- Made of quality leather with a soft suede lining for comfort and durability
- Restricts extremes of motion in the thumb joint
- Allows the user to perform routine hand functions
- The support fits over the thumb and wraps around the wrist
- It is held in place with two hook and loop fasteners

Code		Size	(cm)	DVA:
Left	Right			
FBS283201LXS	FBS283201	XS	Up to 9.5	AR03
FBS283201LS	FBS283201RS	S	9.8 - 10.8	AR03
FBS283201LM	FBS283201RM	M	11.1 - 12.1	AR03
FBS283201LL	FBS283201RL	L	over 12.4	AR03

Measure length from the top thumb-joint, along outside of thumb to the wrist-bone.



## Rolyan Gel Thumb Spica Splint

- Cushions and helps protect the thumb
- Gel shell pad provides gentle pressure on the incision site to help reduce scar formation and hypersensitivity
- Optional polyform stay along radial side of thumb provides additional support to the thumb

Code		Size	(cm)	DVA:
Left	Right			
FBS301623	FBS301624	XS	Up to 9.5	AR03
FBS301625	FBS301626	S	9.5 - 10.8	AR03
FBS301627	FBS301628	M	10.9 - 12	AR03
FBS301629	FBS301630	L	Over 12.1	AR03

Measure length from the top thumb - joint, along outside of thumb to the wrist-bone.



## Rolyan Take Off Thumb Splint

- Made using fabric NuStimWrap
- The splint is available with either a standard plastic thumb stay for increased support, or a mouldable stay for custom fit
- Provides warmth, compression and support to reduce pain
- Easy to apply over joints and helps prevent overuse
- One size fits most

Code		Style	DVA:
Left	Right		
FBS301437	FBS301438	Regular	AR03
FBS301439	FBS301440	With Mouldable Insert	AR03



## Rolyan Thermo-Form Thumb Splint

- These splints contain a pocket on the inside where the thermoplastic piece is inserted.
- The thermoplastic material can be moulded directly in the pocket by pouring in hot water
- The thermoplastic material becomes mouldable in approx. 1 minute, allowing the therapist to mould the splint to the thumb for proper positioning
- The splint comes with one strap

Code		Size	Wrist (cm)	DVA:
Left	Right			
FBS301441	FBS301442	XS	Up to 14	AR03
FBS301443	FBS301444	S	14 - 16.5	AR03
FBS301445	FBS301446	M	16.5 - 19.1	AR03
FBS301447	FBS301448	L	19.1 - 21.6	AR03
FBS301449	FBS301450	XL	21.6 - 23	AR03

Measure wrist circumference.



## Rolyan Polycentric Hinged Ulnar Deviation Splint

- This splint leaves the palm free for gripping objects
- The polycentric hinge allows full flexion and extension of the fingers
- Padded finger stays are malleable for ease of application and to provide optimal alignment
- Ideal for use following MP arthroplasty

Code		Size	(cm)	DVA:
Left	Right			
FBS301452L1	FBS301452	XS	5.7 - 7	AR03
FBS301452L2	FBS301452R2	S	7 - 7.6	AR03
FBS301452L3	FBS301452R3	M	7.6 - 8.6	AR03
FBS301452L4	FBS301452R4	L	8.6 - 9.2	AR03

Measure width from the 2nd to 5th MP to size.



## Rolyan Radial Hinged Deviation Splint

- Soft finger straps permit each finger to be individually aligned for maximum control
- Lined in soft felt, dorsal based splint leaves palm free for function

Code		Size	(cm)	DVA:
Left	Right			
FBS301453L2	FBS301453	S	7 - 7.6	AR03
FBS301453L3	FBS301453R3	M	7.6 - 8.6	AR03
FBS301453L4	FBS301453R4	L	8.6 - 9.2	AR03

Measure width from the 2nd to 5th MP to size.



## Rolyan Comforter Splint

- The Comforter splint holds the wrist and MP joints of the fingers in neutral to reduce stress on muscles and tendons
- Malleable padded stays allow each finger to be individually aligned
- IP joints are free to allow the wearer to manage bedding and night time activities
- The softly padded cover is removable for washing

Code		Size	(cm)	DVA:
Left	Right			
FBS301454L2	FBS301454	S	7 - 7.6	AR03
FBS301454L3	FBS301454R3	M	7.6 - 8.6	AR03
FBS301454L4	FBS301454R4	L	8.6 - 9.2	AR03

Measure width from the 2nd to 5th MP to size.





## Rolyan Hand-Based in-Line Splint

- MCP support straps have reinforced neoprene to prevent over-stretching caused by continual use
- Finger straps support each finger individually
- 2.4 mm neoprene gives needed support without bulkiness
- Neoprene fabric retains warmth, increasing comfort

Code		Size	Wrist (cm)	DVA:
Left	Right			
FBS301455	FBS301456	XS	Up to 14.6	AR03
FBS301457	FBS301458	S	14.6 - 16.5	AR03
FBS301459	FBS301460	M	16.6 - 19.1	AR03
FBS301461	FBS301462	L	Over 19.1	AR03

Measure wrist circumference.



## Finger Flexor Splint

- Aids flexion at the proximal and distal interphalangeal joints on an individual finger

Code	Description	Size	Length	DVA:
FBS301463	Finger Flexor Splint	S	Child	AR03
FBS301463M	Finger Flexor Splint	M	Short	AR03



## Finger Extension Splint

- A dynamic extension splint which resists flexion of the interphalangeal joints and assists in their extension

Code	Description	Size	Length	DVA:
FBS301464	Finger Extension Splint	S	Child	AR03
FBS301464M	Finger Extension Splint	M	Short	AR03
FBS301464L	Finger Extension Splint	L	Long	AR03



## Oppo 4285 Finger Splint

- Lightweight aluminum protects injured finger
- Ventilated foam padding
- Folds over the end of the finger to provide protection and stabilisation

Code	Description	Size	Finger (cm)	DVA:
FBS301465	Oppo 4285 Finger Splint	S	5.5	AR03
FBS3014652	Oppo 4285 Finger Splint	M	7.5	AR03
FBS3014653	Oppo 4285 Finger Splint	L	9.5	AR03

Length of finger (cm).



## Oppo 4280 Baseball Finger Splint

- Help stabilise the phalangeal joints in position
- Malleable aluminum splint can be reshaped to hold finger at an exact degree of flexion or extension
- Provides firm support while injury heals

Code	Description	Size	Finger (cm)	DVA:
FBS301466	Oppo 4280 Baseball Finger Splint	S	8	AR03
FBS3014662	Oppo 4280 Baseball Finger Splint	M	10	AR03
FBS3014663	Oppo 4280 Baseball Finger Splint	L	12	AR03

Length of finger (cm).

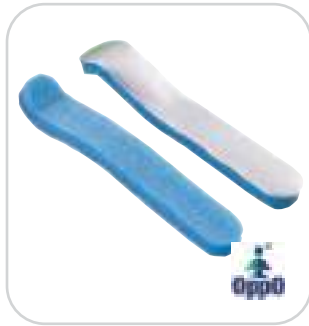

## Oppo 4282 Curved Finger Splint

- Lined and padded with soft, ventilated material
- Curved finger splints support and protect dislocated fracture
- Upward curve at the tip to protect the end of the finger

Code	Description	Size	Finger (cm)	DVA:
FBS301467	Oppo 4282 Curved Finger Splint	S	7	AR03
FBS3014672	Oppo 4282 Curved Finger Splint	M	10	AR03
FBS3014673	Oppo 4282 Curved Finger Splint	L	13	AR03

Length of finger (cm).



## Oppo 4283 Open Thimble Splint

- Malleable aluminum splint for immobilisation of finger
- Protects and stabilises fractures of the distal finger joint
- Encloses finger injuries and protects on four sides

Code	Description	Size	Finger (cm)	DVA:
FBS301469	Oppo 4283 Open Thimble Splint	S	5.5	AR03
FBS3014692	Oppo 4283 Open Thimble Splint	M	6.5	AR03
FBS3014693	Oppo 4283 Open Thimble Splint	L	7.5	AR03

Length of finger (cm).



## Oppo 4182 Wrist/Hand Positioning Splint

- Two unstretchable straps give greater wrist stability
- Incorporating a moulded metal palmar stay which is used to position the wrist and hand
- Insert each two fingers, except thumb, into the two unstretchable straps
- Be sure the metal stay is on palm side of hand, then wrap the strap over hand and secure snugly

- Thread through the buckles and secure the two hook and loop straps to desired compression

Code		Description	Size	Wrist (cm)	DVA:
Left	Right				
FBS301470LS	FBS301470	OPPO 4182 Wrist/Hand Positioning Splint	S	13.1 - 17.1	AR03
FBS301470LM	FBS301470RM	OPPO 4182 Wrist/Hand Positioning Splint	M	17.1 - 21.6	AR03
FBS301470LL	FBS301470RL	OPPO 4182 Wrist/Hand Positioning Splint	L	21.6 - 30.5	AR03

Measure wrist circumference.



## Rolyan Palm Protector With Finger Separator

- Made from closed-cell foam, lined with pile
- Soft finger separator strap weaves between fingers and can be cut to adjust fit
- Hand washable
- One size fits all

Code		Description	DVA:
Left	Right		
FBS282830	FBS282840	Rolyan Palm Protector with Finger Separator	AR03



## Rolyan Palm Shield - Foam

- This foam support wraps around the user's wrist and hand and holds the thumb and fingers in place
- It is held in place with a Velcro closure at the wrist
- The support has four rounded foam sections that separate and position the fingers
- It also has a padded section that rests in the user's palm, and supports and positions the user's thumb

- This hand support is designed for users with moderate to severe hand tightness
- One size fits most adults - left and right fittings

Code		Description	DVA:
Left	Right		
FBS283010	FBS283020	Rolyan Palm Shield - Foam	AR03



## Rolyan Palm Shield-Sof-Gel

- A palm shield with gel which helps prevent skin breakdown in the palm and between the fingers
- Gel in finger separators and palm won't bottom out giving the product a longer life
- Ideal for moderate to severe hand tightness
- Helps prevent finger contractures
- One size fits most adults - left and right fittings

Code		Description	DVA:
Left	Right		
FBS283030	FBS283040	Rolyan Palm Shield - Sof - Gel	AR03



## Rolyan Palm Protector

- Holds fingers out to prevent digging into the palm of the hand
- Cuff fabricated from closed-cell foam lined with a pile fabric
- Pre-rolled and attached to simplify application
- Hand wash, air dry
- One size for each of left and right hand

Code		Description	DVA:
Left	Right		
FBS282860	FBS282880	Rolyan Palm Protector	AR03



## Rolyan Carve-It Hand Positioning Splint

- For use with strokes, Alzheimer's disease, dementia and other neurological impairments
- Helps anatomically position the hand with mild to moderate finger spasticity
- Design allows use with left and right hand
- Easy to modify by cutting foam with an electric knife for a custom fit
- Flat bottom provides easy positioning in bed or on lap tray, arm tray etc
- Removable cover can be hand washed and air dried

Code		Size	(cm)	DVA:
Splint	Replacement Cover			
FBS283075	-	Sm/Med	Up to 7.6	AR03
FBS283070	FBS301472	Lge/XL	7.6 +	AR03

For size, measure width of 2nd to 5th MCP.



## Rolyan Progressive Palm Protector Splint (With Optional Wrist Support)

Choice Guide			Code				DVA:	
			Palm Splint		Palm Splint with Wrist Support			Replacement Pads
Series	Foam Size (cm)	MCP Flexion	Left	Right	Left	Right		
1	2.5	90°	FBS301473	FBS301474	FBS282890	FBS282900	FBS301479	AR03
2	5.1	60°	FBS301475	FBS301476	FBS282910	FBS282920	FBS301480	AR03
2	7.6	30°	FBS301477	FBS301478	FBS282930	FBS282940	FBS301481	AR03

Indications:

Series 1	Tight hands with moderate to severe spasticity or contractures
Series 2	Hands with mild to moderate spasticity or contractures
Series 3	Hands with mild spasticity or contractures, or non - spastic hands, to provide a functional position in a soft splint

- Progressive soft splint for neurological conditions and arthritis
- Adjust splint as condition improves by removing foam palm piece and replacing it with a larger series
- Variable strapping system allows strapping thumb only, fingers only, or both thumb and fingers
- Each splint comes with one foam palm piece
- Splint base is large enough to accommodate all hand sizes and can be modified for a smaller hand by trimming the edges
- Wrist support style has a removable Ezeform stay that can be moulded for wrist extension and D-ring attachments for secure fit
- Available in universal adult size
- Hand wash splint, air dry





## Rolyan Kwik-Form Functional Resting Splint

- Can be custom fitted without tools or heat - simply bend the wire core to the desired position
- Supports the wrist, thumb and fingers in a functional or resting position
- Features hook and loop closures and removable machine washable cover

Code		Size	Wrist (cm)	DVA:
Left	Right			
FBS301482	FBS301483	Sm/Med	Up to 18	AR03
FBS301484	FBS301485	Med/Lge	18cm +	AR03

Measure wrist circumference.



## Rolyan Kwik-Form Progressive Hand Splint

- Can be custom fitted without tools or heat - simply bend the wire core to the desired position
- Supports the hand and wrist and provides progressive extension of the fingers
- Includes 3 hand rolls - as condition progresses, simply replace the hand roll
- For especially tight hands, can be used without hand roll

- Removable cover sewn from comfortable, cool soft material for maximum compliance
- Features hook and loop closures and removable machine washable cover

Splint Code	Replacement Cover Code	Size	Wrist (cm)	DVA:
FBS301490	FBS301492	Sm/Med	Up to 18	AR03
FBS301491	FBS301493	Med/Lge	Up to 18+	AR03

Measure wrist circumference.



## Rolyan AirPro Air Graduate Splint

- Air Therapy-low load prolonged stretch
- Conforms to the shape of the hand accommodating different degrees of finger contracture
- Ideal for severely contracted fingers
- Removable cone shaped palmar air bladder can be used independently of wrist support
- Extra cover included
- Universal size

Code		Description	DVA:
Left	Right		
FBS301494L	FBS301494	Rolyan AirPro Air Graduate Splint	AR03

Universal size, left and right.



## Rolyan SoffPro Functional Resting Hand

- Treats moderate contractures of the wrist/hand/fingers
- Easily adjustable for ulnar radial deviation
- Finger separator and ulnar drift strap available separately to allow custom fitting

Code		Size	Width (cm)	Length (cm)	DVA:
Left	Right				
FBS301495LS	FBS301495	Small	Up to 7.6	Up to 15.2	AR03
FBS301495LM	FBS301495RM	Medium	7.6 - 8.9	15.2 - 20.3	AR03
FBS301495LL	FBS301495RL	Large	8.9 - 10.2	20.3 - 24.1	AR03
FBS301495LC	FBS301495RC	Child	5 - 7.6	17.8	AR03
FBS301495LY	FBS301495RY	Youth	5 - 7.6	20.3	AR03

Width: MP joints (cm). Length: wrist to finger tip (cm).



## Rolyan SoffPro Grip

- Treats moderate to severe contractures of the wrist/hand/fingers
- Easily moulded without tools yet sturdy enough to maintain shape during wear
- Finger separator and ulnar rift strap available separately to allow custom fitting

Code		Size	Width (cm)	Length (cm)	DVA:
Left	Right				
FBS301496LS	FBS301496	Small	Up to 7.6	Up to 15.2	AR03
FBS301496LM	FBS301496RM	Medium	7.6 - 8.9	15.2 - 20.3	AR03
FBS301496LL	FBS301496RL	Large	8.9 - 10.2	20.3 - 24.1	AR03

Width: MP joints (cm). Length: wrist to finger tip (cm).

### DVA Contact Details

P 1300 888 052 | F 1300 787 052 | E [dva@aidacare.com.au](mailto:dva@aidacare.com.au)



For NDIS Item Code, refer to page: 508



- For use with SoftPro Grip and SoftPro functional resting hand splints
- Provides finger separation and mild abduction
- Protects finger skin integrity
- Universal size

Code	Description	Size	DVA:
FBS301497	Rolyan Softpro Finger Separator (Accessory to SoftPro Splint)	Universal	AR03



### Rolyan SoftPro Ulnar Drift Strap (Accessory To SoftPro Splint)

- For use with SoftPro Grip and SoftPro functional resting hand splints
- Holds fingers in comfortable, neutral position

Code	Description	Size	DVA:
FBS301498	Rolyan Softpro Ulnar Drift Strap (Accessory to SoftPro Splint)	Universal	AR03



### Cosmac Cock-Up Resting Hand Splint

- Pre-shaped plastic with velcro fastening straps
- Use for carpal tunnel syndrome, RSI, resting splint

Code		Size	Width (cm)
Left	Right		
FBS301499LM	FBS301499	S/M	7.5
FBS301499LL	FBS301499RL	L	9

Measurement: At the widest part of the knuckles



### Cosmac Cock-Up Resting Hand Splint With Thumb

- Pre-shaped plastic (with thumb) with velcro fastening straps
- Use for carpal tunnel syndrome, RSI, resting splint

Code		Size	Width (cm)
Left	Right		
FBS301500LM	FBS301500	S/M	7.5
FBS301500LL	FBS301500RL	L	9

Measurement: At the widest part of the knuckles



### IMAK Arthritis Gloves

- Design to help relieve aches, pains and stiffness associated with arthritis of the hands
- Provides mild compression for warmth and helps increase circulation
- Made of soft, breathable cotton and comfortable enough to wear all day and night
- Sold as a pair

Code	Size	Width (cm)	DVA:
FBS303522	XS	up to 6.9	AR03
FBS303519	S	up to 7.9	AR03
FBS303520	M	up to 8.9	AR03
FBS303521	L	up to 10	AR03
FBS303523	XL	up to 11.4	AR03

Measurement: At the widest part of the knuckles



## IMAK Active Gloves

- Provide mild compression to enhance blood circulation
- Made of soft, breathable cotton and comfortable enough to wear all day and night
- Anti-slip design on fingers and palm provides excellent grip
- Sold as a pair

Code	Size	Width (cm)	DVA:
FBS303524	S	up to 7.9	AR03
FBS303525	M	up to 8.9	AR03
FBS303526	L	up to 10	AR03

Measurement: At the widest part of the knuckles



## IMAK SmartGlove

- Helps prevent and relieve carpal tunnel syndrome
- Increases comfort and ensures an ergonomically correct wrist position
- Cushions and protects the underside of the wrist, including the pisiform
- Reversible to fit either the left or right hand
- Sold individually

Code	Size	Width (cm)	DVA:
FBS303511	XS	up to 6.9	AR03
FBS303512	S	up to 8.2	AR03
FBS303513	M	up to 9.5	AR03
FBS303514	L	up to 10.8	AR03

Measurement: At the widest part of the knuckles



## IMAK SmartGlove with Thumb

- Helps prevent and relieve carpal tunnel syndrome, De Quervain's and other wrist and thumb pain
- Increases comfort and ensures an ergonomically correct wrist position
- Features a flexible support splint to support your thumb
- Sold individually

Code	Size	Width (cm)	DVA:
FBS303515	XS	up to 6.9	AR03
FBS303516	S	up to 8.2	AR03
FBS303517	M	up to 9.5	AR03
FBS303518	L	up to 10.8	AR03

Measurement: At the widest part of the knuckles



For Crutches  
Refer to Page 268

# Bracing & Supports - Knee



For NDIS Item Code, refer to page: 508



## Oppo 1024 Universal Knee Support

- Designed for all knee sizes with adjustable support
- Open patella relieves pressure
- Provides compression for weak or overstressed knees
- Exclusive reinforced patella stabiliser to prevent displacement
- Retains body heat to warm knee joint and increases blood circulation



## Oppo 1124 Knee Support Short

- Wrap - around design allows for adjustable fit and unrestricted range of motion of the knee
- Open patella design to relieve pressure
- Exclusive reinforced patella stabiliser to prevent displacement
- Heat retention and compression reduces potential for strain or injury

Code	Description	Size	DVA:
FBS301501	Oppo 1024 Universal Knee Support	Universal Size	AR02

Code	Description	Size	DVA:
FBS301502	Oppo 1124 Knee Support Short	Universal Size	AR02



## Oppo 1021 Knee Support Open Patella

- Provides compression for weak or overstressed knees
- Open patella design relieves pressure
- Exclusive reinforced patella stabiliser to prevent displacement
- Helpful for post - operative knee problems, strains and arthritis



## Oppo 1132 Contour Knee Support

- Unique contour shape to snugly fit the knee joint to prevent slipping due to excessive movement
- The adjustable design provides easy application and maximum support
- Breathable CoolPrene® material lined with COOLMAX® behind the knee for optimal comfort

Code	Description	Size	Knee (cm)	DVA:
FBS301508	Oppo 1021 Knee Support Open Patella	S	33.7 - 35.9	AR02
FBS301508M	Oppo 1021 Knee Support Open Patella	M	35.9 - 38.4	AR02
FBS301508L	Oppo 1021 Knee Support Open Patella	L	38.4 - 43.5	AR02
FBS301508XL	Oppo 1021 Knee Support Open Patella	XL	43.5 - 51.1	AR02

Code	Description	Size	Knee (cm)	DVA:
FBS301505	Oppo 1132 Contour Knee Support	S	33 - 39.4	AR02
FBS301505M	Oppo 1132 Contour Knee Support	M	39.4 - 43.2	AR02
FBS301505L	Oppo 1132 Contour Knee Support	L	43.2 - 47	AR02
FBS301505XL	Oppo 1132 Contour Knee Support	XL	47 - 50.8	AR02

Note: Measure around the mid - section of the knee, while in a standing position.

Note: Measure around the mid - section of the knee, while in a standing position.

### General Enquiries

P 1300 133 120 | E sales@aidacare.com.au | W www.aidacare.com.au



## McDavid A408 Thermal Knee Wrap

- Multi purpose knee wrap
- Provides warmth, compression, & protection
- Contoured & darted for a better fit
- Retains body warmth & can increase blood circulation
- Fully adjustable



## McDavid A409 Thermal Knee Wrap Open Patella

- Multi purpose knee wrap
- Provides warmth, compression, & protection
- Contoured & darted for a better fit
- Retains body warmth & can increase blood circulation
- Fully adjustable

Code		Size	DVA:
Black	Beige		
FBS284780	FBS284780BE	Universal Size	AR02

Code		Size	DVA:
Black	Beige		
FBS284790	FBS284790BE	Universal Size	AR02



## Oppo 2029 Open Knee Brace

- Open design for better fit
- For arthritic knee conditions, minor sprains and strains
- Provides firm support and gentle compression over the kneecap
- Improves healing and keeps joints and muscles flexible

Code	Description	Size	Knee (cm)	DVA:
FBS301506	Oppo 2029 Open Knee Brace	S	30.5 - 34.3	AR02
FBS301506M	Oppo 2029 Open Knee Brace	M	34.3 - 38.1	AR02
FBS301506L	Oppo 2029 Open Knee Brace	L	38.1 - 41.9	AR02
FBS301506XL	Oppo 2029 Open Knee Brace	XL	41.9 - 45.7	AR02
FBS301506XXL	Oppo 2029 Open Knee Brace	XXL	45.7 - 49.5	AR02

Note: Measure around the mid - section of the knee, while in a standing position.



## Oppo 2120 Knee Wrap

- Provides comfortable and uniform compression
- Made of unique extra - strength elastic and transverse nylon fibers for long - lasting, heavy - duty support
- Wrap may be pre - positioned for controlled compression

Code	Description	Size	DVA:
FBS301507	Oppo 2120 Knee Wrap	Universal Size	AR02



## Oppo 1125 Knee Support Short Donut

- Adjustable wrap - around design for custom fit
- Open patella design relieves pressure on the kneecap
- Donut shape around the patella for added comfort and support

Code	Description	Size	DVA:
FBS301503	Oppo 1125 Knee Support Short Donut	Universal Size	AR02



## McDavid A402 Thermal Knee Support Open

- Warmth, firm compression & some protection
- Retains body warmth & can increase blood circulation
- Reversible & lined both sides (Heavy duty outer lining for durability)

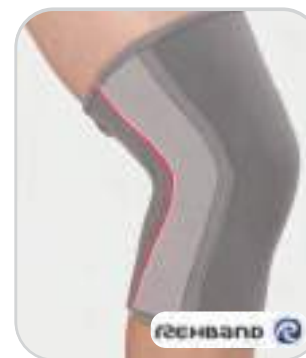

## Rehband 8361 Genu Thermo

- Provides warmth and compression, which helps to reduce pain and improves blood circulation
- Elastic and supple made from a warming material
- Anatomic design with soft trimmings to provide excellent comfort and fit

Code		Size	(cm)	DVA:
Black	Beige			
FBS280970	FBS280975	S	30 - 33	AR02
FBS280971	FBS280976	M	33 - 38	AR02
FBS280972	FBS280977	L	38 - 43	AR02
FBS280973	FBS280978	XL	43 - 51	AR02
FBS280974	FBS280979	XXL	51 - 56	AR02

Note: Measure around the knee joint.

Code	Size	15 cm Below Mid-Patella (cm)	15 cm Above Mid-Patella (cm)	DVA:
FBS301509	XXS	29 - 32	36 - 40	AR02
FBS301509XS	XS	32 - 35	40 - 44	AR02
FBS301509S	S	35 - 38	44 - 48	AR02
FBS301509M	M	38 - 41	48 - 52	AR02
FBS301509L	L	41 - 44	52 - 56	AR02
FBS301509XL	XL	44 - 48	56 - 61	AR02
FBS301509XXL	XXL	48 - 51	61 - 67	AR02

Note: Measure around leg, 15cm above, and 15cm below middle of knee.

### DVA Contact Details

P 1300 888 052 | F 1300 787 052 | E [dva@aidacare.com.au](mailto:dva@aidacare.com.au)



For NDIS Item Code, refer to page: 508







## Rehband 8364 Genu Thermo Open

- Provides warmth and compression, which helps to reduce pain and improves blood circulation
- Supports sensory motor control
- Reduces pressure on the patella
- Anatomic design with soft trimmings to provide excellent comfort and fit
- Can be used for left or right

Code	Size	15 cm Below Mid-Patella (cm)	15 cm Above Mid-Patella (cm)	DVA:
FBS301510	XXS	29 - 32	36 - 40	AR02
FBS301510XS	XS	32 - 35	40 - 44	AR02
FBS301510S	S	35 - 38	44 - 48	AR02
FBS301510M	M	38 - 41	48 - 52	AR02
FBS301510L	L	41 - 44	52 - 56	AR02
FBS301510XL	XL	44 - 48	56 - 61	AR02
FBS301510XXL	XXL	48 - 51	61 - 67	AR02

Note: Measure around leg, 15cm above, and 15cm below middle of knee.



## Rehband 8354 Genu Thermo Fit

- Provides warmth and compression, which helps reduce pain and improve blood circulation
- Supports sensory motor control
- Reduces pressure on the patella
- Straps to ensure optimal fit and comfort
- Anatomic design with soft trimmings to provide excellent comfort and fit
- Two elastic straps, can be used for left or right

Code	Size	15 cm Below Mid-Patella (cm)	15 cm Above Mid-Patella (cm)	DVA:
FBS301511	XXS	29 - 32	36 - 40	AR02
FBS301511XS	XS	32 - 35	40 - 44	AR02
FBS301511S	S	35 - 38	44 - 48	AR02
FBS301511M	M	38 - 41	48 - 52	AR02
FBS301511L	L	41 - 44	52 - 56	AR02
FBS301511XL	XL	44 - 48	56 - 61	AR02
FBS301511XXL	XXL	48 - 51	61 - 67	AR02

Note: Measure around leg, 15cm above, and 15cm below middle of knee.



## Oppo 2021 Open Patella Knee Support

- For arthritic knee conditions, minor sprains and strains provides firms support for the maintenance of joint structures with gentle compression over the kneecap

Code	Description	Size	Knee (cm)	DVA:
FBS301512	Oppo 2021 Open Patella Knee Support	S	30.5 - 34.3	AR02
FBS301512M	Oppo 2021 Open Patella Knee Support	M	34.3 - 38.1	AR02
FBS301512L	Oppo 2021 Open Patella Knee Support	L	38.1 - 41.9	AR02
FBS301512XL	Oppo 2021 Open Patella Knee Support	XL	41.9 - 45.7	AR02

Note: Measure around the mid-section of the knee, while in a standing position.



## BodyAssist 450 Knee Support

- Basic multi purpose slip-on knee support
- Provides a low level of compression & support
- Helps ease painful, injured knees
- Lightweight ventilated elastic for all day comfort
- Retains some body warmth & can increase blood circulation
- Length 18cm

Code	Description	Size	Knee (cm)	DVA:
FBS284340	Body Assist 450 Knee Support	S	Up to 32	AR02
FBS284350	Body Assist 450 Knee Support	M	32 - 37	AR02
FBS284360	Body Assist 450 Knee Support	L	37 - 42	AR02
FBS284370	Body Assist 450 Knee Support	XL	42 - 47	AR02

Note: Measure around the knee joint.



## Oppo 1029 Patella Tendon Strap

- Extra pad provides compression on target area
- Non - slip backing keeps wrap from sliding out of position
- Great for use after an injury or to help prevent injuries
- Reduces vibrations in the femoral groove
- Fits knee circumference 32 - 40.5cm

Code	Description	Size	DVA:
FBS301513	Oppo 1029 Patella Tendon Strap	One size	AR02

Note: Measure around the knee joint.



## Oppo 1429 Jumpers Strap W/Pad

- Specially shaped silicone insert offers extra pressure on the patella
- Adjustable hook and loop strap allows you to apply greater tension if needed
- Minimises potential for future injuries
- Fits knee circumference 32 - 40.5cm

Code	Description	Size	DVA:
FBS301515	Oppo 1429 Jumpers Strap W/Pad	One size	AR02

Note: Measure around the knee joint.



## McDavid A414 Patella Knee Strap

- A semi-tubular buttress in a thermal strap with velcro closure
- For compression and pressure on the patellar tendon



## BodyAssist PSB Patella Stabilising Brace

- Designed according to knee cap taping technique, locking the knee cap
- Anatomically shaped to provide orthopaedic support
- Retains some body warmth & can increase blood circulation
- A great brace for anyone who needs to tape their knee cap

Code		Size	DVA:
Black	Beige		
FBS301516	FBS301517	Universal Size	AR02

Code	Size	Knee (cm)	DVA:
FBS281440	Child	Up to 32	AR02
FBS285270	Regular	32 - 42	AR02
FBS285280	X Large	42+	AR02

Note: Measure around the knee joint.



## Rehband 8360N Genu Carezza Patella Stabiliser

- Keeps patella in correct position
- Prevents patella from luxation
- Supports sensory motor control
- Flexible patella stabiliser
- C-shaped pad, which is adjusted by two separate straps
- Innovative material that combines compression and breathability
- Excellent fit underneath clothes

Code	Size	15 cm Below Mid-Patella (cm)	15 cm Above Mid-Patella (cm)
FBS301520	XXS	29 - 32	36 - 40
FBS301520XS	XS	32 - 35	40 - 44
FBS301520S	S	35 - 38	44 - 48
FBS301520M	M	38 - 41	48 - 52
FBS301520L	L	41 - 44	52 - 56
FBS301520XL	XL	44 - 48	56 - 61
FBS301520XXL	XXL	48 - 51	61 - 67

Note: Measure around leg, 15cm above, and 15cm below middle of knee.



## BodyAssist 43C Elastic Cartilage Knee Brace

- Adjustable front closure, lateral/medial condyle pads & patella cutout
- Firm elastic orthopaedic soft tissue support with additional compression over the medial and lateral meniscus (cartilage)
- Three medial and three lateral spring steel stays provide greater support

Code	Size	Knee (cm)
FBS284255	S	Up to 32
FBS284256	M	32 - 37
FBS284257	L	37 - 42
FBS280765	XL	42 - 47
FBS280766	XXL	47+

Note: Measure around the knee joint.



## Oppo 1030 Knee Stabiliser

- Neoprene circle pad around the patella provides padded protection and stabilisation to prevent patella displacement
- Two medial and lateral stays provide additional support and stability for the knee
- Helps relieve pain from tendonitis and arthritis
- Retains body heat to warm knee joint and increases blood circulation

- Two hook and loop straps insure comfortable fit and stabilisation during activities

Code	Size	Knee (cm)	DVA:
FBS301631	S	33.7 - 37.5	AR02
FBS301631M	M	37.5 - 40.6	AR02
FBS301631L	L	40.6 - 45.1	AR02
FBS301631XL	XL	45.1 - 50.2	AR02

Note: Measure around the knee joint.



## Oppo 1028 Patella Tracker Support

- Prevents patella pain and weakness due to instability
- Helps maintain proper patella position
- Helps prevent Chondromalacia Patella
- The pad design ensures comfortable fit and provides even pressure to the side of the knee
- Does not interfere with normal motion, even when straps are crossed

Code	Size	Knee (cm)	DVA:
FBS301519	XS	30.5 - 33.0	AR02
FBS301519S	S	33.0 - 35.6	AR02
FBS301519M	M	35.6 - 38.1	AR02
FBS301519L	L	38.1 - 40.6	AR02
FBS301519XL	XL	40.6 - 43.2	AR02
FBS301519XXL	XXL	43.2 - 45.5	AR02



## Oppo 1230 Adjustable Knee Stabiliser

- Two medial and lateral spiral stays provide additional support and stability for the knee
- The additional circle pad around the patella provides padded protection and stabilisation to prevent patella displacement
- Open patella design to relieve pressure
- Heat retention and compression reduces potential for strain or injury

Code	Description	Size	DVA:
FBS301524	Oppo 1230 Adjustable Knee Stabiliser	One size	AR02



## Oppo 1130 Knee Stabiliser Adjustable

- Two medial and lateral spiral stays provide additional support and stability for the knee
- Heat retention and compression reduces potential for strain or injury
- Adjustable for custom fit
- Fits knee circumference 32 - 40.5cm

Code	Description	Size	DVA:
FBS301525	Oppo 1130 Knee Stabiliser	One Size	AR02



## Oppo 1033 Knee Support Patella Stabiliser

- Neoprene circle pad around the patella provides protection and stabilisation to prevent patella displacement
- Four neoprene straps provide support directly to patella area
- Two medial and lateral spiral stays provide additional support and stability for the knee
- Helps relieve pain from tendinitis and arthritis
- Retains body heat to warm knee joint and increases blood circulation

Code	Size	Knee (cm)	DVA:
FBS301521	XXS	33.7 - 37.5	AR02
FBS301521M	XS	37.5 - 40.6	AR02
FBS301521L	S	40.6 - 45.1	AR02
FBS301521XL	M	45.1 - 50.2	AR02

Note: Measure around the mid-section of the knee, while in a standing position.



## Rehband 8362N Genu Carezza Knee Support

- Support and stabilisation by coil springs
- Supports sensory motor control
- Wraparound design for easy application
- Lateral and medial coil springs for stability and to prevent the brace from rolling
- Anatomic design with soft trimmings to provide excellent comfort and fit
- Innovative material that combines compression and breathability

Code	Size	15 cm Below Mid-Patella (cm)	15 cm Above Mid-Patella (cm)	DVA:
FBS301526	XXS	29 - 32	36 - 40	AR02
FBS301526XS	XS	32 - 35	40 - 44	AR02
FBS301526S	S	35 - 38	44 - 48	AR02
FBS301526M	M	38 - 41	48 - 52	AR02
FBS301526L	L	41 - 44	52 - 56	AR02
FBS301526XL	XL	44 - 48	56 - 61	AR02

Note: Measure around leg, 15cm above, and 15cm below middle of knee.



## BodyAssist 41S Cross - Cut Elastic Knee Brace

- Anatomically shaped by a cross-cut design that minimises irritation & pressure behind the knee
- Provides orthopaedic support for minor knee joint strains & sprains
- Removable medical support spring stays on sides of the knee joint to provide medio-lateral support
- Brace retains some body warmth & can increase blood circulation
- Lightweight, ventilated elastic for all day comfort

Code	Size	Knee (cm)	DVA:
FBS284180	S	Up to 32	AR02
FBS284190	M	32 - 37	AR02
FBS284200	L	37 - 42	AR02
FBS284210	XL	42 - 47	AR02
FBS284215	XXL	47+	AR02

Note: Measure around the knee joint.



## BodyAssist 42S Knee Support

- An open patella with medial & lateral medical side stays for extra overall support
- Open Patella minimises pressure over the knee cap
- Quality lightweight elastic orthopaedic soft tissue support with additional side supports

Code	Size	Knee (cm)	DVA:
FBS284260	S	30.5 - 35.5	AR02
FBS284270	M	33 - 38	AR02
FBS284280	L	35.5 - 40.5	AR02
FBS284290	XL	40.5 - 46	AR02
FBS284295	XXL	46 +	AR02

Note: Measure around the knee joint.



## McDavid A421 Patella Knee Support

- Delivers firm compression & soft tissue support
- Made of medical grade lightweight neoprene that retains body warmth
- Contoured design for a better fit with two medial and two lateral medical steel stays
- Top and bottom anchor straps to minimise slippage

- Available in black or beige

Code		Size	Knee (cm)	DVA:
Black	Beige			
FBS284820	FBS284852	S	30 - 33	AR02
FBS284830	FBS284853	M	33 - 38	AR02
FBS284840	FBS284854	L	38 - 43	AR02
FBS284850	FBS284855	XL	43 - 51	AR02
FBS284851	FBS284856	XXL	51 - 56	AR02

Note: Measure around the knee joint.



## McDavid A425 Ligament Knee Support

- Delivering firm compression and soft tissue support
- Made of medical grade lightweight neoprene that retains body warmth
- 4 elastic straps that deliver additional support to ligaments
- Horse-shoe buttress to stabilise the knee cap
- Contoured design for a better fit with two medial and two lateral medical steel stays

- Top and bottom anchor straps minimise slippage

Code			Size	Knee (cm)
Black	DVA:	Beige		
FBS284860	AR02	FBS284890	S	30 - 33
FBS284870	AR02	FBS284895	M	33 - 38
FBS284880	AR02	FBS284900	L	38 - 43
FBS284881	AR02	FBS284901	XL	43 - 51
FBS284882	AR02	FBS284902	XXL	51 - 56

Note: Measure around the knee joint.



## Rehband 8353N Genu Direxa Knee Support

- Sensorimotor performance improvements through controlled compression
- Pain relief and functional improvement of the knee joint
- Polycentric joints with extension and flexion stops of the full range of motion
- Innovative material that combines compression and breathability
- For patients with restricted grip force and mobility

Code	Size	15 cm Below Mid-Patella	15 cm Above Mid-Patella	DVA:
FBS301527	XXS	29 - 32	36 - 40	AR02
FBS301527XS	XS	32 - 35	40 - 44	AR02
FBS301527S	S	35 - 38	44 - 48	AR02
FBS301527M	M	38 - 41	48 - 52	AR02
FBS301527L	L	41 - 44	52 - 56	AR02
FBS301527XL	XL	44 - 48	56 - 61	AR02
FBS301527XXL	XXL	48 - 51	61 - 67	AR02

Note: Measure around leg, 15cm above, and 15cm below middle of knee.



## Oppo 1032 Knee Support Post Operative

- Reduces swelling and pain following arthroscopic surgery and enhances protection of periarticular structures
- Provides comfortable and controlled compression with adjustable hook and loop closures
- Front opening design for easy fit and comfort

Code	Size	Knee (cm)	DVA:
FBS301634S	S	33.7 - 37.5	AR02
FBS301634M	M	37.5 - 40.6	AR02
FBS301634L	L	40.6 - 45.1	AR02
FBS301634XL	XL	45.1 - 50.2	AR02

Note: Measure around the mid-section of the knee, while in a standing position.



## BodyAssist 43H Hinged Knee Brace

- Rigid hinges minimise excessive medio - lateral movement of the knee joint, while offering excellent support & stability
- Made from lightweight medical grade orthopaedic elastic & features front closures for easier application
- Top & bottom straps lock the brace in position & minimise movement

Code	Size	Knee (cm)	DVA:
FBS280770	S	Up to 32	AR02
FBS284300	M	32 - 37	AR02
FBS284310	L	37 - 42	AR02
FBS284315	XL	42 - 47	AR02
FBS284220	XXL	47+	AR02

Note: Measure around the knee joint.



## Oppo 1031 Knee Stabiliser Hinged

- Neoprene circle pad around the patella provides padded protection and stabilisation to prevent patella displacement
- Two medial and lateral stays provide additional support and stability for the knee
- Two hook and loop straps insure comfortable fit and stabilisation during activities

- Helps relieve pain from tendinitis and arthritis
- Retains body heat to warm knee joint and increases blood circulation

Code	Size	Knee (cm)	DVA:
FBS301528	S	33.7 - 37.5	AR02
FBS301528M	M	37.5 - 40.6	AR02
FBS301528L	L	40.6 - 45.1	AR02
FBS301528XL	XL	45.1 - 50.2	AR02

Note: Measure around the mid-section of the knee, while in a standing position.



## McDavid A429 PSII Hinged Knee

- Hinged knee with moulded condyle pads that offer superior fit, comfort & protection
- Professional quality bilateral design
- Geared rigid upright polycentric hinges provide additional medial-lateral support
- Features superior horseshoe buttress & hyper-extension stops

- Top & bottom velcro strap locks eliminate brace movement

Code	Size	Knee (cm)	DVA:
FBS301529	S	30 - 33	AR02
FBS3015292	M	33 - 38	AR02
FBS3015293	L	38 - 43	AR02
FBS3015294	XL	43 - 51	AR02
FBS3015295	XXL	51 - 56	AR02

Note: Measure around the knee joint.



## Oppo 2031 Knee Open Patella Support

- May be used for stabilisation and support of the knee following strains, injury or surgery
- Elastic brace with motion hinges provides medial and lateral support for the unstable knee
- Provides firm support for the maintenance of joint structures with gentle compression over the kneecap

- For arthritic knee conditions, minor sprains and strains
- Two hook and loop straps insure comfortable fit

Code	Size	Knee (cm)	DVA:
FBS301530	S	30.5 - 34.3	AR02
FBS301530M	M	34.3 - 38.1	AR02
FBS301530L	L	38.1 - 41.9	AR02
FBS301530XL	XL	41.9 - 45.7	AR02

Note: Measure around the mid-section of the knee, while in a standing position.



## Rehband 8367N Direxa Stable Knee Support

- Sensorimotor performance improvements through controlled compression
- Pain relief and functional improvement of the knee joint
- Polycentric joints with gradual extension and flexion stops (extension 0°; 10°; 20°; 30°; 45°) (flexion 0°; 10°; 20°; 30°; 45°; 60°; 75°; 90°)
- Two non-elastic, circular strap systems

Code	Size	15 cm Below Mid-Patella (cm)	15 cm Above Mid-Patella (cm)	DVA:
FBS301532	XXS	29 - 32	36 - 40	AR02
FBS301532XS	XS	32 - 35	40 - 44	AR02
FBS301532S	S	35 - 38	44 - 48	AR02
FBS301532M	M	38 - 41	48 - 52	AR02
FBS301532L	L	41 - 44	52 - 56	AR02
FBS301532XL	XL	48 - 48	56 - 61	AR02
FBS301532XXL	XXL	48 - 51	61 - 67	AR02

Note: Measure around leg, 15cm above, and 15cm below middle of knee.



## Rehband 8368N Genu Direxa Stable ROM Long

- Sensorimotor performance improvements through controlled compression
- Pain relief and functional improvement of the knee joint
- Four-strap stabilisation
- Polycentric joints with gradual extension and flexion stops (extension 0°; 10°; 20°; 30°; 45°) (flexion 0°; 10°; 20°; 30°; 45°; 60°; 75°; 90°)

Code		Size	15 cm Below Mid-Patella (cm)	15 cm Above Mid-Patella (cm)	DVA:
Left	Right				
FBS301533LXXS	FBS301533	XXS	29 - 32	36 - 40	AR02
FBS301533LXS	FBS301533RXS	XS	32 - 35	40 - 44	AR02
FBS301533LS	FBS301533RS	S	35 - 38	44 - 48	AR02
FBS301533LM	FBS301533RM	M	38 - 41	48 - 52	AR02
FBS301533LL	FBS301533RL	L	41 - 44	52 - 56	AR02
FBS301533LXL	FBS301533RXL	XL	48 - 48	56 - 61	AR02
FBS301533LXXL	FBS301533RXXL	XXL	48 - 51	61 - 67	AR02

Note: Measure around leg, 15cm above, and 15cm below middle of knee.



## Oppo 1036 Knee Support Multi Orthosis

- Functional 3/16" breathable neoprene knee brace
- Polycentric hinge with flexion and extension pin-stops for controlled range of motion
- Increases stability and provides support and protection
- Provides greatest comfort even in the hollow of the knee
- For patients with restricted grip force and mobility
- Lightweight, open patella design

Code	Size	Knee (cm)	DVA:
FBS301534	S	33.7 - 37.5	AR02
FBS301534M	M	37.5 - 40.6	AR02
FBS301534L	L	40.6 - 45.1	AR02
FBS301534XL	XL	45.1 - 50.2	AR02

Note: Measure around the mid-section of the knee, while in a standing position.



## Oppo 4039 Post-Op Motion Control Knee Splint

- Provides stability to an injured or unstable knee by allowing normal knee joint motion with proper settings or stops with in a selected range
- For use following knee surgery, early cast removal or post-operative rehabilitation
- Settings from 0 to 120° flexion and between 0 to 75° extension in 7.5° increments
- Hook and loop closures for uniform compression and support
- Available in three lengths: 46cm, 56cm, 66cm
- Fits knee circumference 43 - 71 cm

Code			Knee (cm)	DVA:
46cm	56cm	66cm		
FBS301536	FBS30153622	FBS30153626	43 - 71cm	AR02

Note: Measure around the knee joint.



## Oppo Post-Op Motion Control Cool Knee Splint

- Precision flexion and extension settings are achievable in a single motion—simply press, rotate and release
- Features a lightweight design, one size fits all
- Designed for greater breathability and patient comfort

Code	Description	Size	DVA:
FBS301537	Post-Op Motion Control Cool Knee Splint	Universal Size	AR02



## Oppo Tri-Panel Knee Immobiliser

- Universal knee immobiliser
- 2 side panels velcro on to the middle panel to allow a range of circumferential sizing
- 3 panel design, length: 51cm

Code	Description	Size
FBS301539	Tri-Panel Knee Immobiliser	Universal Size



## Oppo 4030 Knee Immobiliser

- Provides varying degrees of support and stabilisation for the leg and knee
- Aluminium posterior stays retain proper position for comfort
- Hook and loop closure provides quick, secure fit
- Foam padding reduces slippage and will not fray
- Available in three heights: 46cm, 51cm and 58cm

Code			Size	Thigh (cm)
46 cm	51 cm	58 cm		
FBS301538	FBS301538S51	FBS301538S58	S	33 - 38.1
FBS301538M46	FBS301538M51	FBS301538M58	M	38.1 - 45.7
FBS301538L46	FBS301538L51	FBS301538L58	L	45.7 - 53.3
FBS301538XL46	FBS301538XL51	FBS301538XL58	XL	53.3 - 61

Note: Measure the circumference of the thigh approximately 10cm above the knee.



## Post-Op Knee Immobiliser

- Removable medial, lateral and posterior aluminium stays can be contoured to the shape of the leg for a comfortable and secure fit
- Available in 3 lengths: 40cm, 48cm, 58cm
- The 3 panel design (including the popliteal variation) allows adjustment of the brace
- Will fit calf circumference up to 46.5cm and thigh circumference up to 56.5cm

Code			Size
40 cm	48 cm	58 cm	
FBS301540	FBS301541	FBS301542	Universal Size



## BodyAssist 480W Thigh Tendon Strap

- Rigid tendon strap that delivers firm support and assists in minimising further injury to the thigh
- Designed by a physiotherapist to assist in chronic thigh injury as a rehabilitative device
- Suitable for use in various sports

Code	Description	Size
FBS301543	480W Thigh Tendon Strap	Universal Size



## Rotulax Elastic Knee - Closed Patella

- Provides support for patients with hyperlax patella
- Post-operative support after patellar operations
- Fits left or right patella

Code	Size	Thigh (cm)	DVA:
FBS303527	XS	35 - 38	AR02
FBS303528	S	39 - 42	AR02
FBS303529	M	43 - 46	AR02
FBS303530	L	47 - 49	AR02
FBS303531	XL	50 - 53	AR02
FBS303532	XXL	54 - 57	AR02

Measurement: At the thigh, 15cm above the kneecap



## Rotulax Elastic Knee - Open Patella

- General stabilisation of acute patella injury
- Preventative use in case of hyperlax patella
- Fits left or right patella

Code	Size	Thigh (cm)
FBS303533	XS	35 - 38
FBS303534	S	39 - 42
FBS303535	M	43 - 46
FBS303536	L	47 - 49
FBS303537	XL	50 - 53
FBS303538	XXL	54 - 57

Measurement: At the thigh, 15cm above the kneecap



## Donjoy OA Reaction Web Brace

- A unique and effective way to treat osteoarthritis knee pain utilising patented silicone web technology
- Breathable, open framework
- Low profile design - wear it discreetly under clothing
- Includes undersleeve

Code		Size	Thigh (cm)	DVA:
Right Medial/Left Lateral	Left Medial/Right Lateral			
FBS303444	FBS303451	XS	33 - 39	AR02
FBS303445	FBS303452	S	39 - 47	AR02
FBS303446	FBS303453	M	47 - 53	AR02
FBS303447	FBS303454	L	53 - 60	AR02
FBS303448	FBS303455	XL	60 - 67	AR02
FBS303449	FBS303456	XXL	67 - 75	AR02
FBS303450	FBS303457	XXXL	75 - 81	AR02

Measurement: At the thigh, 15cm above the kneecap



# Bracing & Supports - Thigh & Calf

**I ♥ ndis** For NDIS Item Code, refer to page: 508



## BodyAssist 490 Elastic Slip-On Thigh Support

- General multi purpose slip-on elastic thigh support
- Ideal for holding a hot or cold pack
- Lightweight ventilated cotton elastic for improved comfort
- Retains some body warmth & can increase blood circulation

Code	Description	Size	Thigh (cm)	DVA:
FBS284380	490 Elastic Slip-on Thigh Support	S	Up to 44	AR02
FBS284390	490 Elastic Slip-on Thigh Support	M	44 - 50	AR02
FBS284400	490 Elastic Slip-on Thigh Support	L	50 - 56	AR02
FBS284410	490 Elastic Slip-on Thigh Support	XL	56+	AR02

Note: Measure around mid-section of the thigh.



## Oppo 1040 Slip-On Thigh Support

- Provides comfortable compression for weak or overstressed thigh and hamstring muscles
- Retains body heat to warm the thigh and increase blood circulation
- Helps reduce pain from tendonitis
- Minimises the potential for future injuries

Code	Description	Size	Thigh (cm)	DVA:
FBS301544	1040 Slip-on Thigh Support	S	45.1 - 50.8	AR02
FBS301544M	1040 Slip-on Thigh Support	M	50.8 - 57.2	AR02
FBS301544L	1040 Slip-on Thigh Support	L	57.2 - 62.2	AR02
FBS301544XL	1040 Slip-on Thigh Support	XL	62.2 - 68.9	AR02

Note: Measure around mid-section of the thigh.



## McDavid A478 Thermal Thigh Wrap

- Provides warmth, firm compression for strains & hamstring pulls
- Retains body warmth & can increase blood circulation
- For minor protection & shock absorption & helps reduce muscle strain
- Ideal for corked thigh condition
- Simple application with Velcro closure

Code	Description	Size	DVA:
FBS281375	McDavid A478 Thermal Thigh Wrap	Universal Size	AR02

### DVA Contact Details

P 1300 888 052 | F 1300 787 052 | E [dva@aidacare.com.au](mailto:dva@aidacare.com.au)

**I ♥ ndis** For NDIS Item Code, refer to page: 508

**aidacare**  
HEALTHCARE EQUIPMENT





## Oppo 2420 Silicone Wrap

- Provides localised support and compression, and avoids unnecessary compression to areas where it is not required
- Tension is fully adjustable to provide from light support to total compression
- Can be used for thigh, hamstring, knee or calf
- Cohesive fabric, causing no pain or irritation to the skin whilst in use, comfortable to wear and painless to remove
- 7.5cm width

Code	Description	Size	DVA:
FBS301546	2420 Silicone Wrap	Universal Size	AR02



## BodyAssist N478 Thermal Thigh Wrap

- Provides warmth, firm compression for strains & hamstring pulls
- For minor protection & shock absorption & helps reduce muscle strain
- Simple application with Velcro closure
- One size fits most
- Ideal for coked thigh condition
- Retains body warmth & can increase blood circulation

Code	Description	Size	DVA:
FBS281380	N478 Thermal Thigh Wrap	Universal Size	AR02



## Oppo 1010 Slip-On Shin Support

- Designed to fit the upper portion of the tibia and calf
- Provides compression and support over the calf and shin
- Retains body heat to warm shin and increase blood circulation
- Minimises the potential for future injuries

Code	Description	Size	Shin (cm)	DVA:
FBS301547	1010 Slip-on Shin Support	S	33.0 - 36.2	AR02
FBS301547M	1010 Slip-on Shin Support	M	36.2 - 39.4	AR02
FBS301547L	1010 Slip-on Shin Support	L	39.4 - 42.5	AR02
FBS301547XL	1010 Slip-on Thigh Support	XL	42.5 - 46.4	AR02

Note: Measure around mid-section of the shin.



### General Enquiries

P 1300 133 120 | E [sales@aidacare.com.au](mailto:sales@aidacare.com.au) | W [www.aidacare.com.au](http://www.aidacare.com.au)

# Bracing & Supports - Ankle

**I ♥ ndis** For NDIS Item Code, refer to page: 508



## McDavid A431 Slip-On Thermal Ankle Support

- A general purpose slip-on neoprene ankle support
- Provides all the benefits of thermal compression

Code	Size	Shoe Size
FBS301556	S	37 - 40
FBS3015562	M	40.5 - 42.5
FBS3015563	L	43 - 45
FBS3015564	XL	45.5+

Note: Sizing by European shoe size.



## McDavid A432 Thermal Ankle Support W/Straps

- Thermal slip-on ankle support with 2 orthopaedic elasticised adjustment straps for graduated support
- Provides thermal compression with additional outer support
- Lined both sides
- Outer lining is made of heavy duty nylon for greater durability
- Fits left or right
- Protects and supports without restriction

Code	Size	Shoe Size
FBS301557	S	37 - 40
FBS3015572	M	40.5 - 42.5
FBS3015573	L	43 - 45
FBS3015574	XL	45.5+

Note: Sizing by European shoe size.



## McDavid A430B Open Thermal Ankle Support

- Fully adjustable thermal ankle support with 2 orthopaedic elastic adjustable straps for graduated support, lined both sides
- Outer lining is made of heavy duty nylon for greater durability
- One size fits most
- Provides all the benefits of thermal compression together with added outer support layer
- Protects and supports without restriction and fits left or right

Code	Description	Size	DVA:
FBS301550	A430B Open Thermal Ankle Support	Universal Size	AR01



## McDavid A438 Thermal Ankle Wrap

- One size thermal ankle wrap providing the benefits of heat & compression
- Adjustable closures ensure an optimum fit & easy application & removal
- Allows increased blood circulation
- Fits easily into standard footwear
- Compresses and supports soft tissue while retaining therapeutic heat
- Lined both sides, one size fits most

Code	Description	Size	DVA:
FBS284965	A438 Thermal Ankle Wrap - Beige	Universal Size	AR01

### DVA Contact Details

P 1300 888 052 | F 1300 787 052 | E [dva@aidacare.com.au](mailto:dva@aidacare.com.au)



## BodyAssist 01A10 Elastic Ankle Wrap With Heel Loop

- This one size elastic ankle wrap with loop anchor is simple to apply & very effective
- Simply hook the loop anchor over the heel & start wrapping
- The adjustable touch tape closure assures a perfect fit and locks down anywhere over itself
- Will not stick to skin
- Pull hard & the strap locks rigid
- Orthopaedic elastic that locks like tape
- Fits easily into standard footwear

Code		Size
Black	Beige	
FBS301552B	FBS301552S	Universal Size



## Oppo 1001 Slip-On Thermal Ankle Support

- Open toe and heel design allows full range of movement
- Relieves pain due to strains and stiffness
- Provides compression for weak or overstressed ankles
- Helps ankle heal faster following injury

Code	Description	Size	Ankle (cm)
FBS301553	1001 Slip-on Thermal Ankle Support	S	15.6 - 20.6
FBS301553M	1001 Slip-on Thermal Ankle Support	M	20.6 - 25.7
FBS301553L	1001 Slip-on Thermal Ankle Support	L	25.7 - 30.8
FBS301553XL	1001 Slip-on Thermal Ankle Support	XL	30.8 - 35.9

Note: Measure circumference just above ankle bone.



## Oppo 2004 Slip-On Adj Elastic Ankle Support

- Ideal for weak or unstable ankles, sprains, strains, or twisting injuries
- Provides firm support to the ankle joint with gentle compression
- Increases circulation to relieve pain, speed healing and maintain flexibility
- 35% cotton blend

Code	Size	Ankle (cm)	DVA:
FBS301558	S	15.6 - 21.0	AR01
FBS301558M	M	21.5 - 26.0	AR01
FBS301558L	L	26.5 - 31.0	AR01
FBS301558XL	XL	31.1 - 36.2	AR01

Note: Measure circumference just above ankle bone.



## Oppo 1003 Slip-On Thermal Ankle Support w/strap

- Removable surgical elastic strap allows adjustable compression and support for ankle joint
- Open toe and heel design allows full range of movement
- Relieves pain due to strains or stiffness
- Provides compression for weak or overstressed ankle

Code	Size	Ankle (cm)	DVA:
FBS301554	S	15.6 - 20.6	AR01
FBS301554M	M	20.6 - 25.7	AR01
FBS301554L	L	25.7 - 30.8	AR01
FBS301554XL	XL	30.8 - 35.9	AR01

Note: Measure circumference just above ankle bone.



## Oppo 1008 Slip-On Thermal Ankle Support

- Open heel design allows for comfortable fit and applies less pressure on the sensitive Achilles tendon area
- Detachable strap may be removed when additional compression is not needed
- Flexible spiral springs act like tendons to reinforce the ankle
- Relieves pain due to strains or stiffness
- Provides comfortable compression for weak or overstressed ankles

Code	Size	Ankle (cm)	DVA:
FBS301555	S	15.6 - 20.6	AR01
FBS301555M	M	20.6 - 25.7	AR01
FBS301555L	L	25.7 - 30.8	AR01
FBS301555XL	XL	30.8 - 35.9	AR01

Note: Measure circumference just above ankle bone.



## Oppo 2101 Elastic Ankle Wrap

- Provides comfortable and uniform compression
- Made of unique extra-strength elastic and transverse nylon fibers for long-lasting, heavy-duty support
- Wrap may be pre-positioned for controlled compression

Code	Description	Size	DVA:
FBS301551	2101 Elastic Ankle Wrap	Universal	AR01



## Oppo 2204 Slip-On Adj Elastic Ankle Support

- Provides support and relieves pain from strains and sprains
- Helps minimise further injury

Code	Size	Ankle (cm)	DVA:
FBS301560	S	15.6 - 21.0	AR01
FBS301560M	M	21.5 - 26.0	AR01
FBS301560L	L	26.5 - 31.0	AR01

Note: Measure circumference just above ankle bone.



## McDavid A511 Slip-On Elastic Ankle Support

- Tight weave basic tubular support
- Provides low level support & delivers protection to painful, tired ankles
- Retains some body warmth & can increase blood circulation

Code	Size	Shoe Size	DVA:
FBS301568	S	37 - 40	AR01
FBS3015682	M	40.5 - 42.5	AR01
FBS3015683	L	43 - 45	AR01
FBS3015684	XL	45.5+	AR01

Note: Sizing by European shoe size.



## Oppo Air Lite 4009 Ankle Brace

- Two rigid plastic shells have dual air layers over cushioning foam
- Air is allowed to flow within the air bladder to help reduce swelling
- Heel strap is adjustable to fit a range of sizes, and two adjustable swivel straps ensure proper placement each time
- Limits inversion/eversion while permitting near-normal flexion
- The brace designed for active people resuming activity from an acute ankle sprain

Code	Description	Size	Shoe Size
FBS301569	Air Lite 4009 Ankle Brace Medium	M	40 - 41
FBS301569L	Air Lite 4009 Ankle Brace Large	L	42 - 44

Note: Sizing by European shoe size.



## Fortilax Elastic Ankle

- Support and compression following acute and chronic ankle injury and mild ankle and foot osteoarthritis
- Proprioceptive and neuromuscular stimulation through compression
- Fits either left or right ankle

Code	Size	Ankle (cm)	DVA:
FBS303545	XS	19 - 20	AR01
FBS303546	S	21 - 22	AR01
FBS303547	M	23 - 24	AR01
FBS303548	L	25 - 26	AR01
FBS303549	XL	27 - 28	AR01
FBS303550	XXL	28 - 29	AR01

**Measurement:** Ankle circumference above the malleoli



## Strapping Elastic Ankle

- Support and compression of mild ankle and foot osteoarthritis
- Also suitable following acute and chronic ankle injury and instability
- Protective and prophylactic use for sports activities
- Fits either left or right ankle

Code	Size	Ankle (cm)
FBS303539	XS	19 - 20
FBS303540	S	21 - 22
FBS303541	M	23 - 24
FBS303542	L	25 - 26
FBS303543	XL	27 - 28
FBS303544	XXL	28 - 29

**Measurement:** Ankle circumference above the malleoli



## Stromgren S355 Stirrup Lock Ankle Support

- Designed to conform to the ankle anatomy like tape, without the pain
- Provides solid support incorporating two heel lock & two forefront lock straps
- The straps extend until they are rigid, therefore achieving a taped ankle effect without tape
- The support is locked using Velcro closure enabling easy adjustment
- Restricts inversion & eversion injuries
- No break-in time needed
- Not bulky in a shoe & washable

Code		Size	Shoe Size	DVA:
Black	White			
FBS301561	FBS301561W1	S	37 - 40	AR01
FBS301561B2	FBS301561W2	M	40.5 - 42.5	AR01
FBS301561B3	FBS301561W3	L	43 - 45	AR01
FBS301561B4	FBS301561W4	XL	45.5+	AR01

Note: Sizing by European shoe size.



## BodyAssist 300 Elastic Ankle Brace

- A general purpose adjustable spiral lift elastic ankle brace
- Provides low level orthopaedic support & protection to painful, tired ankles
- Includes an adjustable closure to assist in simple application & allows variation to compression levels
- Retains some body warmth & can increase blood circulation
- Fits easily into standard footwear

Code	Size	(cm)	DVA:
FBS284080	S	Up to 45	AR01
FBS284090	M	45 - 50	AR01
FBS284100	L	50 - 55	AR01
FBS284110	XL	55+	AR01

Note: Measure Figure 8 circumference per illustration.



## BodyAssist 310 Slip-On Ankle Support

- A general purpose spiral lift elastic ankle brace
- Provides low level orthopaedic support & protection to painful, tired ankles
- Retains some body warmth & can increase blood circulation
- Fits easily into standard footwear

Code	Size	(cm)
FBS301563	S	Up to 45
FBS301564	M	45 - 50
FBS301565	L	50 - 55
FBS301566	XL	50+

Note: Measure Figure 8 circumference per illustration.



## BodyAssist 35 Slip-On Basic Ankle

- A general purpose, tubular design support
- Provides low level support & some protection to painful, tired ankles
- Retains body warmth & can increase blood circulation around the ankle
- Fits easily into standard footwear

Code		Size	(cm)
Black	Beige		
FBS301567	FBS301567B1	S	37 - 40
FBS30156702	FBS301567B2	M	40.5 - 42.5
FBS30156703	FBS301567B3	L	43 - 45
FBS30156704	FBS301567B4	XL	45.5+

Note: Measure Figure 8 circumference per illustration.



## Oppo 4005 Total Stability Ankle Brace

- Unique heel-lock strapping system
- Non-stretch figure 8 straps provide firm stability to an injured ankle, preventing inversion and eversion sprains
- Removable bilateral plastic splints for additional support
- Padded heel and tongue fabric is durable and provides added comfort

Code	Description	Size	Shoe Size	DVA:
FBS301572	4005 Total Stability Ankle Brace	S	40 - 42	AR01
FBS301572M	4005 Total Stability Ankle Brace	M	43 - 45	AR01
FBS301572L	4005 Total Stability Ankle Brace	L	46 - 48	AR01
FBS301572XL	4005 Total Stability Ankle Brace	XL	49 - 51	AR01

Note: Sizing by European shoe size.



## McDavid A195 Ultralight Ankle Brace

- Ultra light nylon laceup with fully adjustable figure 8 straps
- Conforms to & supports sprained or weak ankles
- Stirrup straps restrict inversion & eversion injury & simulate costly tape
- Straps fully adjustable without removing shoes or re-lacing
- Elastic heel delivers Achilles tendon support

Code		Size	Shoe Size	DVA:
Black	White			
FBS280901	FBS280906	XS	37.5 - 38.5	AR01
FBS280902	FBS280907	S	39 - 40	AR01
FBS280903	FBS280908	M	40.5 - 42.5	AR01
FBS280904	FBS280909	L	43 - 45	AR01
FBS280905	FBS280910	XL	45.5+	AR01

Note: Sizing by European shoe size.



## McDavid A101 Ankle Guard

- Suitable for those returning from injury or requiring on-going support
- Medical inserts can be removed if desired, although in place they provide additional support & protection
- Replaces costly tape & supports sprained or weak ankles
- Sewn in spring steel medical stays & an elastic heel inset for achilles tendon support
- Fits right or left foot & fully washable

- Notched front allows more free plantar & dorsi flexion

Code		Size	Shoe Size	DVA:
Black	White			
FBS284677	FBS284687	XXS	Up to 37	AR01
FBS284678	FBS284688	XS	37.5 - 38.5	AR01
FBS284679	FBS284689	S	39 - 40	AR01
FBS284680	FBS284690	M	40.5 - 42.5	AR01
FBS284685	FBS284691	L	43 - 45	AR01
FBS284686	FBS284692	XL	45.5+	AR01

Note: Sizing by European shoe size.



## McDavid A199 Lightweight Laced Ankle Brace

- This lightweight version of a laced ankle brace is equally designed to conform to the ankle anatomy & to restrict inversion & eversion (rolling of the ankle)
- Includes sewn in spring steel medical stays & consists of two layers of vinyl/nylon material
- Elastic heel achieves excellent results in supporting the achilles tendon
- Unique lining wicks perspiration away

- Notched front allows more free plantar & dorsi flexion movement

Code		Size	Shoe Size	DVA:
Black	White			
FBS280915	FBS280920	XS	37.5 - 38.5	AR01
FBS280916	FBS280921	S	39 - 40	AR01
FBS280917	FBS280922	M	40.5 - 42.5	AR01
FBS280918	FBS280923	L	43 - 45	AR01
FBS280919	FBS280924	XL	45.5+	AR01

Note: Sizing by European shoe size.



## McDavid A189 Ankle - X Hinged Ankle Brace

- Ankle brace that offers a high level of protection & comfort for athletes of all ages
- Consists of a neoprene sleeve worn inside the rigid component
- Makes this brace very comfortable
- Pivot Hinges
- Lightweight

- Manoeuverability not restricted
- Very effective for high ankle sprains

Code	Description	Size	Shoe Size	DVA:
FBS301573L/XL	McDavid A189 Ankle	L/XL	45+	AR01

Note: Sizing by European shoe size.



## McDavid A188g Ultra Graphite Hinged Ankle

- Ankle support taken to a new level
- Made to the highest professional quality, this hinged ankle brace is designed to treat all ankle injuries (including high ankle sprains)
- Engineered to reduce excessive inversion, eversion and rotation ankle injuries
- Fully Padded & very quick to apply (no laces)
- Ideal for rehab or as injury prevention

- Works well with foot beds & orthotics
- Universal fitting for Left or Right

Code	Size	Shoe Size
FBS301574M	M	41 - 44
FBS301574L	L	45+

Note: Sizing by European shoe size.

# Bracing & Supports - Foot & Toe



For NDIS Item Code, refer to page: 508



## Darco All Purpose Boot

- Rocker Sole reduces plantar pressure under forefoot and heel by over 25%
- Square Toe Design acts as a bumper to protect the toe
- Strap seats foot firmly in shoe to reduce heel slippage and eliminate friction
- Universal Left/Right fit
- Insole can be totally removed to accommodate DARCO's innovative Peg Assist™ customisable off-loading insole

- Removable Forefoot Closure provides security while eliminating buckle pressure

Size	Shoe Size		Code	DVA:
	Female	Male		
XS	4 - 7	-	FBS280240	AJ06
S	7.5 - 10	6 - 8	FBS280241	AJ06
M	10.5 - 13	8.5 - 10	FBS280242	AJ06
L	13+	10.5 - 12	FBS280245	AJ06
XL	-	12.5 - 14	FBS280246	AJ06

Note: Sizing by US shoe size.



## Darco Heelwedge Shoe

- Effective off-loading Footwear
- Reduces Heel pressure by over 26%
- Square Toe Design acts as a bumper to protect the toes and provides better fit
- Ankle Strap seats foot firmly in shoe to reduce heel slippage and eliminate friction
- Zoned Outsole has an aggressive tread under the mid-foot where traction is needed most

- Insole can be totally removed to accommodate DARCO's innovative Peg Assist™ customisable off-loading insole for an even more targeted off-load

Size	Shoe Size		Code	DVA:
	Female	Male		
XS	4 - 7	-	FBS301577	AJ06
S	7.5 - 10	6 - 8	FBS3015771B	AJ06
M	10.5 - 13	8.5 - 10	FBS3015772B	AJ06
L	13+	10.5 - 12	FBS3015773B	AJ06
XL	-	12.5 - 14	FBS3015774B	AJ06

Note: Sizing by US shoe size.



## Darco Med Surg Shoe

- Square Toe Design acts as a bumper to provide extra protection and facilitates better left/right fit
- MetaShank™ protection provides more rigid control under the metatarsal heads
- Rocker Sole reduces plantar pressure on the heel and forefoot by over 25%
- Fully compatible with DARCO's Peg-Assist™ off-loading insole

- Female/Male specific for optimal fit

Size	Shoe Size		Code		
	Female	Male	Female	Male	DVA:
S	4 - 6	6 - 8	FBS301579	FBS301578	AJ06
M	6.5 - 8	8.5 - 10	FBS3015792B	FBS3015782B	AJ06
L	8.5 - 10	10.5 - 12	FBS3015793B	FBS3015783B	AJ06
XL	-	12.5 - 14	-	FBS3015784B	AJ06

Note: Sizing by US shoe size.



## Darco Orthowedge Shoe

- 15° Wedge Sole effectively shifts body weight to the midfoot and heel
- Reduces forefoot pressure by as much as 57%
- Square Toe Design acts as a bumper to protect the toes when k-wires are present and provides better left/right fit
- Insole can be totally removed to accommodate DARCO's innovative Peg-Assist™ customisable off-loading insole

- Zoned Outsole has an aggressive tread under the mid-foot where traction is needed most

Size	Shoe Size		Code	DVA:
	Female	Male		
XS	4-7	-	FBS301580	AJ06
S	7.5-10	6 - 8	FBS3015801B	AJ06
M	10.5-13	8.5 - 10	FBS3015802B	AJ06
L	13+	10.5 - 12	FBS3015803B	AJ06
XL	-	12.5 - 14	FBS3015804B	AJ06

Note: Sizing by US shoe size.



## Darco Soffie Shoe

- Economical, post-op shoe indicated for soft tissue trauma or surgery
- Semi-rigid metatarsal shank provides control of forefoot motion
- Tissue friendly upper material conforms to bony abnormalities and is breathable
- Easy to fasten hook and loop straps
- Female/Male specific for optimal fit
- Fits left & right foot

Size	Shoe Size		Code		
	Female	Male	Female	Male	DVA:
S	4 - 6	6 - 8	FBS280230	FBS280233	AJ06
M	6.5 - 8	8.5 - 10	FBS280231	FBS280234	AJ06
L	8.5 - 10	10.5 - 12	FBS280232	FBS280235	AJ06
XL	-	12.5 - 14	-	FBS280236	AJ06

Note: Sizing by US shoe size.



## Cosmac Cast Shoe

- Curved 'rocker' sole for easy ambulation
- Canvas upper with velcro closures at front and back
- Symmetrical shape fits left & right foot

Code	Description	Size	Shoe Length (cm)	DVA:
FBS301583S	Cosmac Cast Shoe	S	23	AJ06
FBS301583M	Cosmac Cast Shoe	M	27	AJ06
FBS301583L	Cosmac Cast Shoe	L	32	AJ06



## Darco Body Armor Cast Shoe

- Ultimate cast protection in a new modern design that will appeal to all patients
- Soft but durable EVA provides shock absorption while protecting the cast from the elements
- Unique bungee closure system is easy to use, easy to adjust and prevents the heel from slipping out of the cast shoe

- Soft, durable TPR
- Fits left & right foot

Size	Shoe Size		Code	DVA:
	Female	Male		
XS	Up to 5	-	FBS301582	AJ06
S	5.5 - 8	-	FBS3015821	AJ06
M	8.5 - 10	6 - 8	FBS3015822	AJ06
L	10.5 - 13	8.5 - 11	FBS3015823	AJ06
XL	13.5+	11.5 - 14	FBS3015824	AJ06

Note: Sizing by US shoe size.

### DVA Contact Details

P 1300 888 052 | F 1300 787 052 | E [dva@aidacare.com.au](mailto:dva@aidacare.com.au)



For NDIS Item Code, refer to page: 508





## Darco Slimline Cast Boot

- Be adapted to fiberglass casts, bulky compression bandages and a variety of wound care applications, making it one of the most versatile cast shoes on the market
- Forefoot Closure can be adjusted to accommodate casts or bandages
- Symmetrical shape fits left & right foot
- Higher Ankle Strap adds stability
- Rocker Sole allows for a smooth roll throughout the gait pattern

Size	Shoe Size		Code	DVA:
	Female	Male		
XS	Up to 5	-	FBS301583	AJ06
S	5.5 - 8	-	FBS3015831B	AJ06
M	8.5 - 10	6 - 8	FBS3015832B	AJ06
L	10.5 - 13	8.5 - 11	FBS3015833B	AJ06
XL	13.5+	11.5 - 14	FBS3015834B	AJ06

Note: Sizing by US shoe size.



## Xceltrax Walker Boot - Standard

- Provides support and comfort to help promote healing for patients with mild to severe foot and ankle injuries
- Lightweight and ergonomic design
- Available in short or tall

Size	Shoe Size		Code		DVA:
	Female	Male	Short	Tall	
XS	3.5 - 5.5	2 - 4	FBS303437	FBS303432	AR19
S	6 - 8	4.5 - 7	FBS303438	FBS303433	AR19
M	8.5 - 11.5	7.5 - 10.5	FBS303439	FBS303434	AR19
L	11.5 - 13.5	10.5 - 12.5	FBS303440	FBS303435	AR19
XL	13.5+	12.5+	FBS303441	FBS303436	AR19

Note: Sizing by US shoe size.



## Xceltrax Walker Boot - Air

- Provides support and comfort to help promote healing for patients with mild to severe foot and ankle injuries
- The soft liner has an integrated pump design making the pneumatic liner simple to inflate and adjust
- Available in short or tall

Size	Shoe Size		Code		DVA:
	Female	Male	Short	Tall	
XS	3.5 - 5.5	2 - 4	FPP303714	FPP303709	AR19
S	6 - 8	4.5 - 7	FPP303715	FPP303710	AR19
M	8.5 - 11.5	7.5 - 10.5	FPP303716	FPP303711	AR19
L	11.5 - 13.5	10.5 - 12.5	FPP303717	FPP303712	AR19
XL	13.5+	12.5+	FPP303718	FPP303713	AR19

Note: Sizing by US shoe size.



## AirSelect Elite

- The Elite is the most advance walking boot, engineered to provide the ultimate in protection, comfort and oedema control
- SoftStrike technology absorbs and dissipates shock, while the light weight and lab-tested rocker sole combine to encourage a natural gait and a continuation of everyday activities
- Suitable for use in: stable fractures of the foot/ankle/lower leg; severe ankle sprain; post-operative immobilisation

Size	Shoe Size		Code	DVA:
	Female	Male		
XS	Up To 5	Up To 4	FPP303703	AR01
S	5 - 8	4 - 7	FPP303701	AR01
M	8 - 11	7 - 10	FPP303700	AR01
L	11 - 15	10 - 13	FPP303699	AR01
XL	15+	13+	FPP303702	AR01

Note: Sizing by US shoe size.



## AirSelect Short

- The Elite is the most advanced walking boot, engineered to provide the ultimate in protection, comfort and oedema control
- Suitable for use in: stable fractures of the foot/ankle/lower leg; severe ankle sprain; post-operative immobilisation
- SoftStrike technology absorbs and dissipates shock, while the light weight and lab-tested rocker sole combine to encourage a natural gait and a continuation of everyday activities

Size	Shoe Size		Code
	Female	Male	
XS	Up To 5	Up To 4	FPP303708
S	5 - 8	4 - 7	FPP303706
M	8 - 11	7 - 10	FPP303705
L	11 - 15	10 - 13	FPP303704
XL	15+	13+	FPP303707

Note: Sizing by US shoe size.



## Drop Foot Ankle Foot Orthosis Open

- Limits plantar flexion, common peroneal nerve injuries
- Full length sole
- Can be adjusted for a custom fit by heating, cutting and grinding
- Available in left or right fitting

Size	Shoe Size	Code		DVA:
		Left	Right	
XS	4 - 5	FBS301588LXS	FBS301588	AR19
S	5 - 7	FBS301588LS	FBS301588RS	AR19
M	7 - 9	FBS301588LM	FBS301588RM	AR19
L	9 - 12	FBS301588LL	FBS301588RL	AR19

Note: Sizing by US shoe size.



## Drop Foot Ankle Foot Orthosis

- Designed to hold the foot correctly
- Supports the foot to stop dragging
- Fits easily into shoe, heat mouldable, easily trimmed

Size	Shoe Size	Code		DVA:
		Left	Right	
S	Up to 38	FBS301589LS	FBS301589	AR19
M	39 - 43	-	FBS301589RM	AR19
L	44 - 46	FBS301589LL	FBS301589RL	AR19
XL	47+	FBS301589LXL	FBS301589RXL	AR19

Note: Sizing by European shoe size.



## BodyAssist Heel Spur Heel Cups

- Silicone Medical Gel provide exceptional heel support, protection & comfort
- Ideal for sports use, gardening, factory staff, construction workers, office staff & for people who stand on hard surfaces
- Heel Spur Pads are made from a unique Medical Silicone Gel compound that assists to dissipate shock & shear, caused by impact to the heel & foot
- They emulate the fatty tissue, usually found on the underfoot

- Damaging stress forces normally absorbed by the body's musculoskeletal system, are now absorbed by the pad & away from the body

Size	Shoe Size	Code	DVA:
S	37- 40	FBS281210	AR04
M	40.5 - 42	FBS2812102	AR04
L	42.5+	FBS2812103	AR04

Note: Sizing by European shoe size.



## Valgus 4050 Arch/ Metatarsal Support

- Anatomically designed moulded rubber with leather cover
- Metatarsal dome
- Available in narrow and wide fittings
- Supplied in pairs



## Foot Up Drop Foot Orthosis

- A lightweight ankle-foot orthosis
- Provides visible improvements in gait by supporting the foot
- The cushioned ankle wrap is made from a breathable, 3 layer material
- The plastic inlay fits discreetly in the shoe and is practically invisible when worn
- Shoeless wrap accessory also available

Shoe Size	Code		
	Narrow	Wide	DVA:
33	FBS301590	-	AR04
34	FBS301590/100/34	-	AR04
35	FBS301590/100/35	-	AR04
36	FBS301590/100/36	-	AR04
37	FBS301590/100/37	-	AR04
38	FBS301590/100/38	FBS301590/200/38	AR04
39	FBS301590/100/39	FBS301590/200/39	AR04
40	FBS301590/100/40	FBS301590/200/40	AR04
41	FBS301590/100/41	FBS301590/200/41	AR04
42	FBS301590/100/42	FBS301590/200/42	AR04
43	-	FBS301590/200/43	AR04
44	-	FBS301590/200/44	AR04
45	-	FBS301590/200/45	AR04
46	-	FBS301590/200/46	AR04

Size	Ankle Circum (cm)	Foot Circum (cm)	Description	Code	DVA:
M	18 - 21	-	Foot Up Drop Foot Orthosis	FBS303504	AR19
L	22 - 26	-	Foot Up Drop Foot Orthosis	FBS303505	AR19
XL	27 - 33	-	Foot Up Drop Foot Orthosis	FBS303506	AR19
S	-	< 20	Wrap Accessory	FBS303507	AR19
M	-	20 - 24	Wrap Accessory	FBS303508	AR19
L	-	24 - 28	Wrap Accessory	FBS303509	AR19
XL	-	> 28	Wrap Accessory	FBS303510	AR19

Note: Sizing according to European (metric) shoe size.



## BodyAssist Heel Spur Pads

- These Heel Spur Pads gently cushion the heel, while dissipating shock and shear generated by heel strike
- A removable 'tear drop' central plug allows the heel centre to be suspended around a supportive ring of silicone gel
- The pads fit snugly into the heel of a shoe

- Shock attenuation properties of this material have been proven effective in modifying heel strike trauma

Size	Shoe Size	Code	DVA:
S	Up to 38	FBS301598	AR04
M	38.5 - 42	FBS3015982	AR04
L	42.5+	FBS3015983	AR04

Note: Sizing by European shoe size.



## BodyAssist Gel Shoe Insole

- Provides overall support, protection, comfort & help reduce painful shock waves to the body & lighten the load on joints
- Ideal for sports use, gardening, factory staff, construction workers, office staff & for people who stand on hard surfaces
- Made from a unique Medical Silicone Gel compound that assists to dissipate shock & shear, caused by impact to the heel & foot

- Suitable for managing minor cases of splayfoot
- Damaging stress forces normally absorbed by the body's musculoskeletal system, are now absorbed by the footbeds & away from the body

Size	Shoe Size	Code	DVA:
XS	37 - 38	FBS281200	AR04
S	39 - 41	FBS281201	AR04
M	41 - 43	FBS281202	AR04
L	44 - 46	FBS281203	AR04
XL	47+	FBS281204	AR04

Note: Sizing by European shoe size.

### General Enquiries

P 1300 133 120 | E sales@aidacare.com.au | W www.aidacare.com.au



## Trio Heel Elevators

- Trio elevators come in different heights and should be placed under the heel area of the orthotic
- Choose between sizes small, medium or large
- They are manufactured from extra firm density to prevent wearing out or crushing
- Available in 4, 6 and 8mm rises

Size	Shoe Size	Code			DVA:
		4mm	6mm	8mm	
S	Up to 37	FBS3016024S	FBS3016026S	FBS3016028S	AR04
M	38 - 43	FBS3016024M	FBS3016026M	FBS3016028M	AR04
L	44+	FBS3016024L	FBS3016026L	FBS3016028L	AR04

Note: Sizing by European shoe size.



## Darco Peg-Assist

- Designed for use in most DARCO square-toe shoes, other than the DARCO Med-Surg Shoe (for which DA-PTQ Insoles should be used)
- Removable pegs allow for localised off-loading of wounds and ulcerations of the foot
- Pressure reduced by as much as 60% while allowing patient to remain ambulatory
- Poron® cover eliminates the incidence of ring oedema and edge abrasion

Size	Shoe Size		Code	DVA:
	Female	Male		
XS	Up to 5	-	FBS301699XS	AR04
S	5.5 - 8	-	FBS301699S	AR04
M	8.5 - 10	6 - 8	FBS301699M	AR04
L	10.5 - 13	8.5 - 11	FBS301699L	AR04
XL	13.5+	11.5 - 14	FBS301699XL	AR04

Note: Sizing by US shoe size.



## Hallufix Bunion Aid

- A 3-in-1 aid that provides the benefits of a day and a night splint for: bunion pain relief, protection and correction
- Bunion Aid is a hinged bunion splint with adjustable straps and a comfortable gel cushion that protects irritated tissue, distributes pressure and provides corrective support
- Wearing this aid helps prevent bunion progression, overlapping toes, and hammer toes; limiting the need for surgery

Description	Size	Code	DVA:
Hallufix Bunion Aid	Universal	FBS303443	AR04
Hallufix Bunion Aid Replacement Kit	Universal	FBS303442	AR04



## Footbionics Dual Density

- Provides good support for athletic activities or active patients
- A comfortable cushioning top layer of 2mm OrthoLite
- Can help with shin splints, Achilles tendon pain, stress fractures

Size	Shoe Size	Code	DVA:
XXS	32-34	FBS303503	AR04
XS	35-37	FBS303501	AR04
S	38-40	FBS303499	AR04
M	41-43	FBS303498	AR04
L	44-46	FBS303497	AR04
XL	46-48	FBS303500	AR04
XXL	49-51	FBS303502	AR04

Note: Sizing by US shoe size.



## Achilles 1400 Heel Protection Sleeve

- The soft, comfortable gel pad protects the posterior of the heel from friction while gently compressing and reducing pressure
- Washable and reusable
- Slim profile design fits most footwear

Code	Description	Size	DVA:
FBS301606	Achilles 1400 Heel Protection Sleeve	One Size (Small/Medium)	AR01



## Oppo 1408 Achilles Brace W/Silicone Pad

- The concentric ripples on the pad provide intermittent massage - like compression, to effectively reduce edema, relieve spasm and speed up the recovery process
- CoolPrene® material provides shock absorption, dynamic compression and better breathability on the injured ankle over prolonged use
- The butterfly shaped pad is anatomically designed to fit the Achilles tendon and provide support during motion

Size	Ankle (cm)	Code		DVA:
		Left	Right	
S	15.6 - 20.6	FBS301605LS	FBS301605	AR02
M	20.6 - 25.7	FBS301605LM	FBS301605RM	AR02
L	25.7 - 30.8	FBS301605LL	FBS301605RL	AR02
XL	30.8 - 35.9	FBS301605LXL	FBS301605RXL	AR02

Note: Measure circumference just above ankle bone.



## Adjustable Night Splint

- Patented Formfit 3D molded technology allows for variable padding thickness in strategic locations for superior comfort and fit
- Soft lycra lined foam interior is plush and breathable, eliminating heat build-up
- Three lycra lined foam padded straps with user friendly centre release buckles ensure immobilisation while maintaining comfort across the flexor tendons
- Adjustable dorsi-flexion straps provide a gentle stretching of the plantar fascia and achilles tendon.

Size	Female Shoe Size	Male Shoe Size	Code	DVA:
S	Up to 7.5	Up to 7	FBS301607	AR04
M	8 - 10.5	7.5 - 10	FBS301607M	AR04
L	11+	10.5+	FBS301607L	AR04

Note: Sizing by US shoe size.



## Hallux Valgus 510 Night Strap

- A light and flexible strap to unload the joints of the big toe
- Especially designed for nightly or post-operative usage
- Padded with skin-caring and breathable material
- Provides pain relief and guides the big toe
- Universal size - specify left or right foot

Code		Size	DVA:
Left	Right		
FBS301608L	FBS301608	Universal Size	AR04



## Rehband Hallux Valgus 509 Day Strap

- A light and flexible strap to unload the joints of the big toe
- Padded for optimal comfort
- Can be used with or without shoes
- Gives pain relief and may be a condition for a normalised function of the muscles, guides the big toe
- Universal size - specify left or right foot

Code		Size	DVA:
Left	Right		
FBS301609L	FBS301609	Universal Size	AR04



## Darco Toe Alignment Splint

- Low profile metatarsal band fits easily into most footwear and reduces slippage
- Soft toe straps will not irritate skin
- Special T-Strap gently guides toe(s) into proper alignment for post-procedural healing

- One sizes fits all
- Latex Free
- Colour - White

Code	Description	DVA:
FBS301610	Darco Toe Alignment Splint	AR02



## Slip - Resistant Socks

- Provides warmth, comfort and peace of mind, with the tread on the bottom
- Available with single or double imprint
- Supplied in pairs

Size	Shoe Size	Colour	Code	DVA:
				Single Imprint
S	5 - 7	Teal	PTS642548	AR29
M	7.5 - 10	Tan	PTS642549	AR29
L	>10.5	Grey	PTS642550	AR29
XL	Bariatric	Royal Blue	PTS642551	AR29
Double Imprint				DVA:
S	5 - 7	Teal	PTS642544	AR29
M	7.5 - 10	Tan	PTS642545	AR29
L	>10.5	Grey	PTS642546	AR29
XL	Bariatric	Royal Blue	PTS642547	AR29

Note: Sizing by US shoe size.



## Arthritis Sock

- Helps relieve aches, pains and stiffness associated with arthritis of the feet
- Provides mild compression for warmth and to help increase circulation
- Soft, breathable cotton material
- Supplied in pairs

Size	Female Shoe Size	Male Shoe Size	Code
S	6 - 8	5 - 7	PTS642552
M	8.5 - 11.5	7.5 - 9.5	PTS642553
L	12 - 15.5	10 - 14	PTS642554

Note: Sizing by US shoe size.



For Mobility  
Walking Aids  
Refer to Page 253

# Male Support



For NDIS Item Code, refer to page: 508



## Dale Abdominal Binder

- Single ply stretch loop elastic (latex-free)
- Velcro closure anywhere on belt for perfect fit
- Full, even pressure and aids abdominal muscle
- Sizing: available in either 23cm (pictured) or 30cm widths, both in S, M and L sizes, Colour: white

Code		Size	Waist (cm)
23 cm Wide	30 cm Wide		
FBS280280	FBS280350	S	Up to 114
FBS280290	FBS280360	M	114 - 157
FBS280300	FBS280370	L	152 - 191

Sizing: measure circumference of waist.



## Scudotex 644 Elastic Hernia Underpants w/Pads

- Designed with special highly compressive fabric
- Anatomical shape ensures support for the abdominal area to prevent muscle prolapse and provide a balanced inguinal compression
- Foam pads fit into pockets to support inguinal hernia

Code	Size	Waist (cm)	Hip (cm)	DVA:
FBS301611	M	80 - 86	90 - 98	AR14
FBS3016114	L	86 - 92	96 - 104	AR14
FBS3016115	XL	92 - 99	102 - 111	AR14
FBS3016116	XXL	99 - 106	109 - 118	AR14
FBS3016117	XXXL	106 - 114	116 - 126	AR14

Measure waist and hip circumference (cm).



## Scudotex 609 Hernia Support Belt w/Pads

- Inguinal truss with anatomic protective front in hygienic elastic and cotton fabric
- Adjustable leg straps go under the thighs and attach at the back to allow correct inguinal compression
- Designed with two removable rubber pads covered with hygienic cotton
- Back adjustable opening

Code	Size	Waist (cm)	DVA:
FBS301612	S	75 - 80	AR14
FBS3016123	M	80 - 86	AR14
FBS3016124	L	86 - 92	AR14
FBS3016125	XL	92 - 99	AR14
FBS3016126	XXL	99 - 106	AR14
FBS3016127	XXXL	106 - 114	AR14
FBS3016128	XXXXL	114 - 122	AR14

Measure waist circumference (cm).



## BodyAssist 590 Hernia Belt

- Removable foam pads
- Under leg straps
- Easy velcro fastening and adjustment
- Made of lightweight material construction & assists to inhibit skin irritation
- The belt can be worn whilst showering or swimming

Code	Size	Waist (cm)	DVA:
FBS301613	XS	65 - 75	AR14
FBS3016131	S	75 - 85	AR14
FBS3016132	M	85 - 95	AR14
FBS3016133	L	95 - 105	AR14
FBS3016134	XL	105 - 115	AR14

Measure waist circumference (cm).

### General Enquiries

P 1300 133 120 | E sales@aidacare.com.au | W www.aidacare.com.au



## Scudotex 682 Inguinal Hernia Belt - Heavy Duty

- Quality inguinal truss is strong elastic
- Soft cotton edges for greater comfort
- Back adjustable
- Leather-covered pads
- Adjustable leg straps
- Double pads

Code	Description	Size	Waist (cm)	DVA:
FBS301614	682 Inguinal Hernia Belt - Heavy Duty	S	75 - 80	AR14
FBS3016143	682 Inguinal Hernia Belt - Heavy Duty	M	80 - 86	AR14
FBS3016144	682 Inguinal Hernia Belt - Heavy Duty	L	86 - 92	AR14
FBS3016145	682 Inguinal Hernia Belt - Heavy Duty	XL	92 - 99	AR14
FBS3016146	682 Inguinal Hernia Belt - Heavy Duty	XXL	99 - 106	AR14

Measure waist circumference (cm).



## McDavid A310 Athletic Support

- A multi-purpose supporter featuring a power-knit pouch with Intera for rapid drying and cooling
- Provides greater resistance to bacteria and mildew, and the odours and skin irritation they produce
- More comfortable than cotton or synthetics
- Incorporates an 8cm knit waistband and 1cm leg straps
- High rubber content assures maximum support and durability

Code	Size	Waist (cm)	DVA:
FBS301618	S	66 - 82	AR09
FBS3016182	M	82 - 97	AR09
FBS3016183	L	97 - 112	AR09
FBS3016184	XL	112 - 128	AR09

Measure waist circumference (cm).



## Supreme Suspensory Lightweight

- Lightweight scrotal support
- Designed to hold and lift the scrotum
- Relieves the strain and fatigue of swollen or sagging testicles
- Opening for penis

Code	Description	Size	Waist (cm)	DVA:
FBS301620	Suspensory Lightweight	S	76 - 89	AR09
FBS30162014	Suspensory Lightweight	M	89 - 104	AR09
FBS30162015	Suspensory Lightweight	L	104 - 117	AR09
FBS30162015XL	Suspensory Lightweight	XL	117 - 130	AR09

Measure around waist (cm).



## Truform 243 Suspensory - Heavy Duty

- For larger scrotal swelling/enlargement
- Heavy duty construction
- 4.5cm elastic web waistband with 'claw-buckle' fastening
- Strong mesh pouch
- 2cm elastic leg-straps
- Opening for penis
- Sized according to pouch
- Medium is the size most often selected

Code	Description	Size	DVA:
FBS301621	243 Suspensory - Heavy Duty	M	AR09
FBS301621L	243 Suspensory - Heavy Duty	L	AR09
FBS301621XL	243 Suspensory - Heavy Duty	XL	AR09



## TSL Scrotal Support - Extra Large

- For extreme scrotal swelling/enlargement provides support and comfort by alleviating heavy sensation
- Comfortable to wear
- Soft Powernet fabric

Code	Description	Size	Combined Scrotum Size	DVA:
FBS301617	Scrotal Support - Extra Large S	S	Orange	AR09
FBS301617M	Scrotal Support - Extra Large M	M	Rockmelon	AR09
FBS301617L	Scrotal Support - Extra Large L	L	Watermelon	AR09



## BodyAssist Testicle Support - Suspensory

- For post-surgical conditions and before injury
- Ventilated elastic for cool, comfortable and extended use
- Helps to relieve the strain and fatigue of swollen testicles

Code	Description	Size	Size Guide	DVA:
FBS303494	Testicle Support - Suspensory	S	Regular Size Testicles	AR09
FBS303495	Testicle Support - Suspensory	M	Regular Size Testicles	AR09
FBS303496	Testicle Support - Suspensory	XL	Very Swollen/Overly Elongated Testicles	AR09



VISIT OUR  
 *Scooter*   
SPECIALS!



**Pride**<sup>®</sup> **SCOOTERS**  
Mobility Products Corp.

Go-Go LX with CTS



Pathrider 130 XL Pursuit



Celebrity Deluxe XL





# Pressure Care & Circulation

# Contents

- P 444** Protection - General
- P 448** Protection - Hip
- P 453** Protection - Skin + Limb
- P 457** Compression - Legwear
  - P 459 - Dr. Comfort
  - P 459 - GloriaMed
  - P 463 - Ibici
  - P 465 - Jobst
  - P 467 - Mediven
  - P 473 - Sigvaris
  - P 475 - Solaris
  - P 480 - TED Anti-Embolism
  - P 481 - Venosan
  - P 488 - Stocking Accessories
- P 490** Compression - Armwear
  - P 491 - Gloves (Norco/Isotoner/Handeze)
  - P 492 - Jobst
  - P 495 - Mediven
  - P 498 - Sigvaris
  - P 499 - Solaris
- P 502** Compression - Lymphoedema



# Protection - General



For NDIS Item Code, refer to page: 508



## Sheepskin Natural Gold Overlay

- Genuine Australian lambs wool overlay provides additional comfort to an existing mattress
- Soft pile allows air circulation to keep skin dry

Code	Description	Length	Width	DVA:
PTA502500	Sheepskin Overlay	1000 mm	750 mm	AB11



## Sheepskin Hi Temp Classic Mattress Overlay

- A full covered medical sheepskin bed overlay, designed to cover head to toe
- Suitable for long term patients where shear and friction are a concern

Code	Description	Length	Width	DVA:
PTA521400	Sheepskin Mattress Overlay	1250 mm	750 mm	AB11



## Sheepskin Hi Temp Medical Overlay

- Medical grade sheepskin is a versatile product that can be used in the bed, on a chair or on a car seat
- Assists in pressure reduction, will absorb water, transfer heat away from the body and reduce shear and friction

Code	Description	Length	Width	DVA:
PTA521500	Medical Sheepskin Overlay	1000 mm	650 mm	AB11



## Sheepskin Leg Rest Cover

- High quality medical grade sheepskin covers provide natural comfort for any wheelchair
- Provide excellent skin protection and comfort

Code	Description	DVA:
PTA522100	Wheelchair Cover	AB11
PTA522101	Wheelchair Calf Protector Cover	AB11



## Gel & Foam Underarm Crutch Covers

- Fit easily over the existing foam of the underarm/axilla crutches providing a comfortable support surface for the user

Code	Description
PTA509020	Gel and Foam Underarm Crutch Axilla Covers
PTA509021	Gel Underarm Crutch Handle Covers



## Sheepskin Cushion/Back Cover

- The Cushion It Sheepskin Cover can be used directly on a seat or back canvas of a wheelchair
- Can be placed over standard foam cushions to increase pressure care and absorb perspiration

Code	Description	Length	Width	DVA:
PTA521300	Sheepskin Hi Temp - Cushion/Back Cover	500 mm	500 mm	AB11



### Gel Armrest Pads

- Ultimate gel comfort and protection for the elbows and wrists
- Distributes pressure efficiently to help avoid harmful pressure-related problems
- Durable neoprene nylon surface for easy cleaning

Code	Description	Length	Width	DVA:
PTA508400	Gel Armrest Pads (Pair)	88.9 mm	304.8 mm	AP14
PTA508425	Gel Armrest Pads (Pair)	88.9 mm	355.6 mm	AP14
PTA508450	Gel Armrest Pads (Pair)	88.9 mm	406.4 mm	AP14



### Gel Armrest Trough Liner

- Fits onto the Ottobock trough channel forearm pad armrest
- Provides a comfortable, supportive gel support pad for the user

Code	Description	Length
PTA508470	Gel Armrest Trough Liner - Medium	330.2 mm
PTA508480	Gel Armrest Trough Liner - Large	482.6 mm



### Gel Calf Support Panel

- Provide comfortable support to the lower legs in the seating position
- Single piece model features large gel pad, with 6 velcro secure straps
- Split Panel model allows use of swing away legrests without removal of the calf panel

Code	Description	Fits Wheelchair	DVA:
PTA508500	Gel Calf Support Panel (Single)	40.64 - 50.8 cm	AP14
PTA508550	Gel Calf Support Panel (Pair)	40.64 - 50.8 cm	-



### Pressure Care Assist

- Can be used anywhere in the bed to assist with pressure care
- Made from medical grade sheepskin
- Helps reduce the risk of pressure area breakouts in the heels, sacrum, shoulders or head

Code	Description	DVA:
PTA521600	Pressure Care Assist	AB11



### Gel & Foam Footplate Protector Covers

- Designed to fit over existing footplates on a wheelchair
- Highly efficient at distributing pressure thereby avoiding harmful pressure-related problems

Code	Description	Size	DVA:
PTA508600	Gel Covers (Pair)	203.2 x 152.4 mm	AP14
PTA508610	Gel Covers w/ Adhesive Back (Pair)	203.2 x 152.4 mm	-
PTA508615	Gel Cover (Single)	279.4 x 228.6 mm	-



### Gel Knee Protector Buttons

- Provide a soft surface to protect the users knees from bumping against legrests
- Attach to the inside of the legrests on a wheelchair
- Includes mounting hardware

Code	Description	DVA:
PTA508800	Gel Knee Protector Buttons - (3.18) Swing Away Legrests	AP14
PTA508820	Gel Knee Protector Buttons - (3.18) Elevating Legrests	AP14
PTA508810	Gel Knee Protector Buttons - (1.98) Swing Away Legrest	AP14
PTA508830	Gel Knee Protector Buttons - (1.98) Elevating Legrest	AP14



### Heelift Suspension Boot

- Designed by orthopaedic surgeons specifically for prevention and treatment of heel pressure ulcers
- Effectively eliminates heel pressure by suspending the heel in air
- Two options available: Smooth or Convoluted

Code	Description	DVA:
PTA509200	Heelift Suspension Boot Smooth	AB11
PTA509100	Heelift Suspension Boot Convoluted	AB11



### Sheepskin Short Slipper Boot

- Assists in the prevention of pressure ulcers on the feet with an existing injury or condition
- Designed for use primarily in bed, wheelchair use or recliner chair use

Code	Description	Shoe Size US	DVA:
PTA521897	Short Slipper Boot - XX-Small	3 - 4	AB11
PTA521898	Short Slipper Boot - X-Small	5 - 6	AB11
PTA521899	Short Slipper Boot - Small	7 - 8	AB11
PTA521900	Short Slipper Boot - Medium	9 - 10	AB11
PTA521901	Short Slipper Boot - Large	11 - 12	AB11
PTA521902	Short Slipper Boot - X-Large	13 - 14	AB11
PTA521903	Short Slipper Boot - XX-Large	14 - 15	AB11



### aspire Heel Protector

- Soft breathable natural cotton fabric
- Cushioning silicone fibre inner promotes airflow for skin microclimate management
- Seams are located within padding folds to avoid pressure points

Code	Description	DVA:
PTA503360	Heel Protector	AB11

#### DVA Contact Details

P 1300 888 052 | F 1300 787 052 | E [dva@aidacare.com.au](mailto:dva@aidacare.com.au)



For NDIS Item Code, refer to page: 508



## Sheepskin Wrap Around Boot

- Wrap Around Sheepskin Boots designed for those at risk of foot ulcers and other types of tissue damage
- Constructed with low profile EVA sole, these boots can be worn outside



## Sheepskin Pressure Care Boot

- Sheepskin Boots designed for those at risk of foot ulcers and other types of tissue damage
- Constructed with low profile EVA sole, these boots can be worn outside

Code	Description	Shoe Size US	DVA:
PTA521704	Wrap Around Boot - XX-Small	3 - 4	AB11
PTA521705	Wrap Around Boot - X-Small	5 - 6	AB11
PTA521706	Wrap Around Boot - Small	7 - 8	AB11
PTA521707	Wrap Around Boot - Medium	9 - 10	AB11
PTA521708	Wrap Around Boot - Large	11 - 12	AB11
PTA521709	Wrap Around Boot - X-Large	13 - 14	AB11
PTA521710	Wrap Around Boot - XX-Large	14 - 15	AB11

Code	Description	Shoe Size US	DVA:
PTA521697	Pressure Care Boot - XX-Small	3 - 4	AB11
PTA521698	Pressure Care Boot - X-Small	5 - 6	AB11
PTA521699	Pressure Care Boot - Small	7 - 8	AB11
PTA521700	Pressure Care Boot - Medium	9 - 10	AB11
PTA521701	Pressure Care Boot - Large	11 - 12	AB11
PTA521702	Pressure Care Boot - X-Large	13 - 14	AB11
PTA521703	Pressure Care Boot - XX-Large	14 - 15	AB11



## Sheepskin Tall Slipper Boot

- This product has been designed to protect the entire lower limb
- The Tall Slipper Sheepskin Boot can be worn in bed, in a chair or wheelchair and allows the use of compression bandages or support hosiery



## Sheepskin Sovereign Snug

- Beautifully crafted Sheepskin Snugs will accommodate mild foot oedema whilst offering support and comfort
- Made especially from carefully selected lambskin material

Code	Description	DVA:
PTA520500	Tall Slipper Boot - One Size Fits All	AB11

Code	Description	Shoe Size US	DVA:
PTA521905	Sovereign Snug - Small	7 - 8	AB11
PTA521906	Sovereign Snug - Medium	9 - 10	AB11
PTA521907	Sovereign Snug - Large	11 - 12	AB11



## Heel Protectors Silicone® Fibre

- Provides comfort and assists in the prevention of pressure build up in the heel area
- Silicone hollow core fibres provide soft comfortable support, while still keeping the rest of the foot cool in warm weather
- Sold as a pair



## Bed Heel Elevator

- Wedge-shaped contoured foam provides excellent support for the lower leg
- Rigid foam aids blood flow and reduces pressure

Code	Description	Length	Width	Height	DVA:
PTA503350	Heel Protectors Silicone® Fibre	140 mm	100 mm	30 mm	AB11

Code	Description	DVA:
PTA509050	Bed Heel Elevator	AB17



## ROHO Heelpad

- ROHO Heelpad offers an adjustable therapeutic environment which aids in the healing of heel and elbow ischemic ulcers
- Made from soft, latex free neoprene the heelpad is extremely durable



## Sheepskin Heel Supports

- Protect the heel from ulcerations caused by bumps and knocks
- Made from medical grade sheepskin
- Wraps around the heel and ankle leaving the rest of the foot unencumbered

Code	Description	DVA:
PTC541600	ROHO Heelpad	AB17

Code	Description	Show Size US	DVA:
PTA521199	Heel Supports - Small (Pair)	7 - 8	AB11
PTA521200	Heel Supports - Medium (Pair)	9 - 10	AB11
PTA521201	Heel Supports - Large (Pair)	11 - 12	AB11



## Heel Protectors Spenco

- Made from medically treated, washable natural cotton / polyester
- One size fits all, with a velcro band closer



## Heel/Elbow Protector (With Gel Pad)

- Gel Elbow/Heel Protectors are made from a comfortable, stretchable acrylic/spandex
- Designed to prevent trauma or wearing of the heel or elbow
- Sold as a pair

Code	Description	Length	Width	Height	DVA:
PTA530200	Heel Protectors Spenco	140 mm	100 mm	30 mm	AB11

Code	Description	Size	DVA:
PTA506400	Gel Heel/Elbow Protector - Small	230 mm	AR29
PTA506500	Gel Heel/Elbow Protector - Large	280 mm	AR29
PTA506600	Gel Heel/Elbow Protector - X-Large	330 mm	AR29



## Elbow Lift Suspension Pad

- Cushions and elevates the elbow to min
- minimise surface contact
- Helps protect the olecranon and olecranon bursa from friction burns and contusions
- Latex free



## Sheepskin Elbow Protector

- Provides elbow pressure point control
- Assists in avoiding skin tears, bruising and other tissue damage
- Easy and convenient velcro fastening
- Sold as a pair

Code	Description
PTA508200	Elbow Lift Suspension Pad

Code	Description	DVA:
PTA521100	Elbow Protector (One Size Fits All)	AB11



## Sheepskin Palm Protector

- Provides comfort for patients with hand contractures
- Designed to offer moisture absorption, reducing the likelihood of maceration
- One size fits all

Code	Description	DVA:
PTA521104	Palm Protector (Ambidextrous)	AB11

**Brochures also available. Please contact us for a copy.**



## More from the Recovery Range



Aspire Vogue Carbon Fibre Seat Walker  
WAF705350  
(Refer to Page 247)

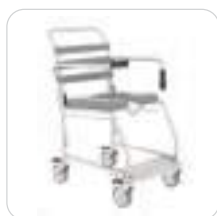

Aspire Shower Commode with Platform Footrest  
BTC066000  
(Refer to Page 20)



Ottobock Cushions  
(Refer to Page 149)

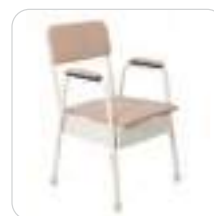

Aspire Bedside Commode  
BEC045005  
(Refer to Page 78)



Aspire High Back Day Chair  
CHP208050  
(Refer to Page 106)



Foam Mattresses  
(Refer to Page 71)



Pillows & Supports  
(Refer to Page 89)



Aspire Evoke 2 Wheelchairs - Range  
(Refer to Page 266)

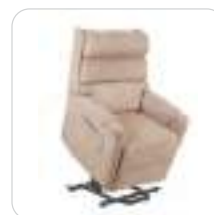

Aspire Signature Lift Recline Chair - Space Saver  
CHP197700  
(Refer to Page 111)



Bed Cradles & Bed Poles  
(Refer to Page 86)

### DVA Contact Details

P 1300 888 052 | F 1300 787 052 | E [dva@aidacare.com.au](mailto:dva@aidacare.com.au)



For NDIS Item Code, refer to page: 508

# Protection - Hip



For NDIS Item Code,  
refer to page: 508



## HipSaver



### Overview

- One of the most serious injuries, due to a fall, is a fractured hip - especially amongst those 65 and older
- While medications, often increase the risk of falls and fall-related injuries, poor vision and difficulty in moving put the elderly at risk of a fall that results in a fatal or debilitating hip injury or hip fracture
- Seniors often develop a fear of falling, causing them to limit activities and leading to reduced mobility. HipSaver products restore confidence of motion to the elderly, both preserving physical health and increasing senior mobility
- Designed with the user in mind, HipSaver products are incredibly soft and comfortable to wear, whilst offering the most effective and superior protection
- HipSaver is available in a variety of designs to suit all types of wearers needs, ranging from the elderly in nursing home settings to those for seniors who daily participate in exercise programs and even robust activities such as jogging
- Whether you need hip protection for your personal use, or for your loved ones, or you are seeking hip protection for your Group Home, Nursing Home, or other Institution, HipSaver has a product to suit your needs

### To Order

Use the Size Guide to select your size, then choose your preferred model and the appropriate code

### Size Guide

- Sizing of all HipSaver products is from this guide
- Measure around widest part of hip (over incontinence products if applicable)

Size	Hips (cm)	Size	Hips (cm)
XS	70 - 79	L	100 - 112
S	80 - 89	XL	113 - 127
M	90 - 99	XXL	128 - 146



## HipSaver - Nursing Home (Sewn-In Pads)

Designed for the mobility and comfort of residents plus convenience and peace of mind for carers

- Full, soft fabric crotch perfectly accommodates incontinence pads or diapers
- Elastic waistband and large leg openings for easy dressing and toileting
- Wearable 24 hours a day - comfortable to sleep in
- A popular all-round choice for most wearers
- Choose from High Compliance or High Compliance With Tailbone Pad for those at risk of falling backward
- The Veterans Kit consists of 6 garments



DVA: AR28

Size	Nursing Home - High Compliance		Nursing Home - High Compliance With Tailbone Pad		Nursing Home - Veterans Kit (6 Garments)	
	Code - Male	Code - Female	Code - Male	Code - Female	Code - Male	Code - Female
XS	PTA510810	PTA510300	PTA492155	PTA492149	PTA513906	PTA513900
S	PTA510900	PTA509900	PTA492156	PTA492150	PTA513907	PTA513901
M	PTA510700	PTA509700	PTA492157	PTA492151	PTA513908	PTA513902
L	PTA510500	PTA509500	PTA492158	PTA492152	PTA513909	PTA513903
XL	PTA511100	PTA510100	PTA492159	PTA492153	PTA513910	PTA513904
XXL	PTA511225	PTA510220	PTA492160	PTA492154	PTA513911	PTA513905

## Nursing Home - Pads & Pants - Separate



DVA: AR28

Size	Nursing Home - Pants Only		Nursing Home - Starter Kit (3 Pants & 1 Pair Pads)		Nursing Home - Veterans Kits (6 Pants & 2 Pairs Pads)	
	Code - Male	Code - Female	Code - Male	Code - Female	Code - Male	Code - Female
XS	PTA512094	PTA512045	PTA511010	PTA510400	PTA512406	PTA512412
S	PTA512095	PTA512050	PTA511000	PTA510000	PTA512407	PTA512413
M	PTA512090	PTA512040	PTA510800	PTA509800	PTA512408	PTA512414
L	PTA512080	PTA512030	PTA510600	PTA509600	PTA512409	PTA512415
XL	PTA512070	PTA512020	PTA511200	PTA510200	PTA512410	PTA512416
XXL	PTA512060	PTA512010	PTA511210	PTA510250	PTA512411	PTA512417

## HipSaver - Slim Fit (Sewn-In Pads)

Ideal for fashion conscious and active elders - those who are at risk of hip fracture, but reject uncomfortable and obvious hip protection products. Looks good, feels good and pulls on just like regular underwear.

- Soft, thin (13 mm) pads, tapered for protection with style
- Made from ultra-soft breathable polycotton with form fitting Spandex®
- SlimFit can accommodate an incontinence pad
- Fully machine washable and dryable, even at high temperature
- Choose from High Compliance or High Compliance with Tailbone Pad for those at risk of falling backward
- The Veterans Kit consists of 6 garments



DVA: AR28

Size	SlimFit - High Compliance		SlimFit - High Compliance With Tailbone Pad		SlimFit - Veterans High Compliance Kit (6 Garments)	
	Code - Male	Code - Female	Code - Male	Code - Female	Code - Male	Code - Female
XS	PTA493705	PTA493701	PTA513803	PTA513801	PTA513880	PTA513820
S	PTA493710	PTA493700	PTA513804	PTA513798	PTA513881	PTA513821
M	PTA493720	PTA493600	PTA513805	PTA513799	PTA513882	PTA513822
L	PTA493730	PTA493500	PTA513806	PTA513800	PTA513883	PTA513823
XL	PTA493740	PTA493450	PTA513807	PTA513797	PTA513884	PTA513824
XXL	PTA493745	PTA493400	PTA513808	PTA513802	PTA513885	PTA513825

### DVA Contact Details

P 1300 888 052 | F 1300 787 052 | E [dva@aidacare.com.au](mailto:dva@aidacare.com.au)



For NDIS Item Code, refer to page: 508





## Slim Fit - Pads & Pants - Separate



DVA: AR28

Size	Slim Fit - Pants Only		Slim Fit - Starter Kit (3 Pants & 1 Pair Pads)		Slim Fit - Veterans Kits (6 Pants & 2 Pairs Pads)	
	Code - Male	Code - Female	Code - Male	Code - Female	Code - Male	Code - Female
XS	PTA494090	PTA494053	PTA513650	PTA513210	PTA512418	PTA512424
S	PTA494080	PTA494055	PTA513600	PTA513200	PTA512419	PTA512425
M	PTA494075	PTA494050	PTA513500	PTA513100	PTA512420	PTA512426
L	PTA494070	PTA494045	PTA513400	PTA513250	PTA512421	PTA512427
XL	PTA494065	PTA494040	PTA513700	PTA513300	PTA512422	PTA512428
XXL	PTA494060	PTA494035	PTA513750	PTA513350	PTA512423	PTA512429

## HipSaver - Quick Change (Sewn-In Pads)

Provides the same features and benefits of the Nursing Home model, but with the convenience of a snap down crotch panel.

- Incontinence pads and diapers can be changed easily and quickly either while the wearer is standing or lying down
- Fabric covered low profile snaps for ease and comfort
- Not suitable for wearers toileting themselves
- Laundry safe for washing and drying up to 95°C
- The Veterans Kit consists of 6 garments



DVA: AR28

Size	Quick Change - High Compliance		Quick Change - High Compliance With Tailbone Pad		Quick Change - Veterans High Compliance Kit (6 Garments)	
	Code - Male	Code - Female	Code - Male	Code - Female	Code - Male	Code - Female
XS	PTA512975	PTA512968	PTA513000	PTA512994	PTA512988	PTA512982
S	PTA512976	PTA512969	PTA513001	PTA512995	PTA512989	PTA512983
M	PTA512978	PTA512970	PTA513002	PTA512996	PTA512990	PTA512984
L	PTA512979	PTA512971	PTA513003	PTA512997	PTA512991	PTA512985
XL	PTA512980	PTA512972	PTA513004	PTA512998	PTA512992	PTA512986
XXL	PTA512981	PTA512973	PTA513005	PTA512999	PTA512993	PTA512987

## Quick Change - Pads & Pants - Separate



DVA: AR28

Size	Quick Change - Pants Only		Quick Change - Starter Kit (3 Pants & 1 Pair Pads)		Quick Change - Veterans Kits (6 Pants & 2 Pairs Pads)	
	Code - Male	Code - Female	Code - Male	Code - Female	Code - Male	Code - Female
XS	PTA494054	PTA494151	PTA513912	PTA512840	PTA512430	PTA512436
S	PTA494056	PTA494152	PTA513913	PTA512900	PTA512431	PTA512437
M	PTA494057	PTA494153	PTA513914	PTA512800	PTA512432	PTA512438
L	PTA494058	PTA494154	PTA513915	PTA512810	PTA512433	PTA512439
XL	PTA494059	PTA494155	PTA513916	PTA512820	PTA512434	PTA512440
XXL	PTA494061	PTA494156	PTA513917	PTA512830	PTA512435	PTA512441

## HipSaver - Open Bottom (Sewn-In Pads)

Requested by nursing staff for residents needing a garment that permits easy self-toileting.

- The open crotch design is perfect for patients with urge incontinence or challenges in getting clothing on or off
- This garment is worn against the skin underneath any incontinence products, and allows a resident's normal underwear to be worn over the top of the protector
- Reduces accidents due to the 'fumble factor' - ideal for Parkinson's sufferers
- Laundry safe for washing and drying up to 95°C
- Suitable for both male and female users
- The Veterans Kit consists of 6 garments



DVA: AR28

Size	Open Bottom - High Compliance - Unisex	Open Bottom - Veterans High Compliance Kit - Unisex (6 Garments)
XS	PTA512398	PTA492701
S	PTA512399	PTA492702
M	PTA512401	PTA492703
L	PTA512402	PTA492704
XL	PTA512403	PTA492705
XXL	PTA512404	PTA492706

### General Enquiries

P 1300 133 120 | E sales@aidacare.com.au | W www.aidacare.com.au



## Open Bottom - Pads & Pants - Separate



DVA: AR28

Size	Open Bottom - Pants Only - Unisex	Open Bottom - Starter Kit - Unisex (3 Pants & 1 Pair Pads)	Open Bottom - Veterans Kits - Unisex (6 Pants & 2 Pairs Pads)
XS	PTA512550	PTA512405	PTA512442
S	PTA512540	PTA512400	PTA512443
M	PTA512530	PTA512100	PTA512444
L	PTA512520	PTA512150	PTA512445
XL	PTA512510	PTA512200	PTA512446
XXL	PTA512500	PTA512300	PTA512447

## HipSaver - Interim Overpant (Sewn-In Pads)

Immediate hip protection.

- ¾ length unisex pants with sewn-in hip protection pad
- Immediate hip protection for new admissions, acute care and short stay patients
- Residents with temporary changes in risk factors
- As a 'stop gap' component of your Falls Safety Programme while you order regular HipSaver for ongoing hip protection
- Suitable for both male and female users
- Colour - grey



DVA: AR28

Size	Interim Overpant - Unisex	Interim Overpant - With Tailbone Protection - Unisex
XS	PTA534107	PTA534108
S	PTA534107S	PTA534108S
M	PTA534107M	PTA534108M
L	PTA534107L	PTA534108L
XL	PTA534107XL	PTA534108XL
XXL	PTA534107XXL	PTA534108XXL

## HipSaver - Track Pants (Sewn-In Pads)



Stylish hip protection for active seniors (Unisex)

- HipSaver Track Pants have the same all-soft hip protectors as other HipSaver garments
- Smartly designed in classic navy blue & pre-shrunk to fit properly (washable with regular laundry)
- The loose ankle hem prevents legs from binding and provides added comfort
- 2 lengths - regular (height under 170 cm), long (over 170 cm)
- Suitable for both male and female users

Options:

- Hip Protection with Tailbone Padding (protects against backward falls)
- Hip Protection with Knee Pads (proper positioning and protects against forward falls)



DVA: AR28

Size	Track Pants	Track Pants with Knee Pad	Track Pants with Tailbone Pad	Track Pants with Tailbone & Knee Pad
Regular (User Height Under 170cm)				
XS	PTA534109	PTA534111	PTA534110	PTA534112
S	PTA534109RS	PTA534111S	PTA534110RS	PTA534112S
M	PTA534109RM	PTA534111M	PTA534110RM	PTA534112M
L	PTA534109RL	PTA534111L	PTA534110RL	PTA534112L
XL	PTA534109RXL	PTA534111XL	PTA534110RXL	PTA534112XL
XXL	PTA534109RXXL	PTA534111XXL	PTA534110RXXL	PTA534112XXL
Long (User Height Over 170cm)				
XS	PTA534109LXS	PTA534111LXS	PTA534110LXS	PTA534112LXS
S	PTA534109LS	PTA534111LS	PTA534110LS	PTA534112LS
M	PTA534109LM	PTA534111LM	PTA534110LM	PTA534112LM
L	PTA534109LL	PTA534111LL	PTA534110LL	PTA534112LL
XL	PTA534109LXL	PTA534111LXL	PTA534110LXL	PTA534112LXL
XXL	PTA534109LXXL	PTA534111LXXL	PTA534110LXXL	PTA534112LXXL

### DVA Contact Details

P 1300 888 052 | F 1300 787 052 | E [dva@aidocare.com.au](mailto:dva@aidocare.com.au)



For NDIS Item Code, refer to page: 508



## HipSaver - Shorts (Sewn-In Pads) - Unisex



Immediate hip protection.

- HipSaver Shorts have the same all-soft hip protectors as other HipSaver garments
- Smartly designed in classic navy blue
- Pre-shrunk to fit properly, and washable with regular laundry
- Six hip sizes offer a perfect fit for any active body
- Also available with tailbone protection which offers additional security for those who tend to fall backwards



DVA: AR28

Size	Shorts - Unisex	Shorts with Tailbone Protection - Unisex
XS	PTA534113	PTA534114
S	PTA534113S	PTA534114S
M	PTA534113M	PTA534114M
L	PTA534113L	PTA534114L
XL	PTA534113XL	PTA534114XL
XXL	PTA534113XXL	PTA534114XXL

## Hornsby Comfy Hips



### Overview

- Provides protection from injuries caused by falls. Australian designed, owned and manufactured

### To Order

Use the Size Guide to select your size, then choose your preferred model and the appropriate code

### Size Guide

Size	Hips (cm)
XXS	50 - 60
XS	60 - 70
S	70 - 80
M	80 - 90
L	90 - 100
XL	100 - 110
XXL	110 - 120



Measure around the waist when standing (cm)

- Available with either Sewn-In Shields, or as pants with removable shields (shields sold separately)
- Available in either unisex styles, or male style (with fly opening)
- Comfortable fabric - 97% cotton
- Range of 7 sizes with durable woven elastic waist band



DVA: AR28

Size	Comfy Hip (Sewn-In Shields)		Comfy Hip (Pants Only)	
	Code - Unisex	Code - Male	Code - Unisex	Code - Male
XXS	PTA512448	PTA512449	PTA512450	PTA512451
XS	PTA512448XS	PTA512449XS	PTA512450XS	PTA512451XS
S	PTA512448S	PTA512449S	PTA512450S	PTA512451S
M	PTA512448M	PTA512449M	PTA512450M	PTA512451M
L	PTA512448L	PTA512449L	PTA512450L	PTA512451L
XL	PTA512448XL	PTA512449XL	PTA512450XL	PTA512451XL
XXL	PTA512448XXL	PTA512449XXL	PTA512450XXL	PTA512451XXL
One Size	Protector Shields - Comfy Hip (Pair)		PTA512452	

### General Enquiries

P 1300 133 120 | E sales@aidacare.com.au | W www.aidacare.com.au



# Protection - Skin & Limb

I ♥ ndis For NDIS Item Code, refer to page: 508

## DermaSaver - Limb & Skin Protectors



### Overview

- Protects from pressure, friction and minor traumas while providing ample airflow

### To Order



DVA: AR29

Choose your preferred model, select your size and order using the appropriate code

## DermaSaver - Hand & Finger Garments

Size	Knuckle Protector	Dermamitt	Palm Pillow	Finger Separator (One Size Fits All)
S/M	PTA533301SM	PTA533302SM	PTA533303SM	PTA533300
L/XL	PTA533301LXL	PTA533302LXL	PTA533303LXL	

## DermaSaver - Forearm & Elbow Garments



DVA: AR29

Size	Forearm (cm) (widest part)	Forearm Tube	Elbow Tube (2 Layers)	Double Elbow Tube (4 Layers)	Zip Tube
XS	13 - 18	PTA533306	PTA533304	PTA533305	PTA533312
S	18 - 25	PTA533306S	PTA533304S	PTA533305S	PTA533312S
M	25 - 30	PTA533306M	PTA533304M	PTA533305M	PTA533312M
L	30 - 38	PTA533306L	PTA533304L	PTA533305L	PTA533312L
XL	38 - 46	PTA533306XL	PTA533304XL	PTA533305XL	PTA533312XL

**Measurement:** All measurements are circumferences

### DVA Contact Details

P 1300 888 052 | F 1300 787 052 | E [dva@aidacare.com.au](mailto:dva@aidacare.com.au)



For NDIS Item Code, refer to page: 508





## DermaSaver - Arm Garments



DVA: AR29



Size	Forearm (cm) (widest part)	Style	Arm Tube	Arm Tube (with Knuckle Protector)
XS	13 - 18	with Single Elbow	PTA533308	PTA533311
		with Double Elbow	PTA533010	
S	18 - 25	with Single Elbow	PTA533308S	PTA533311S
		with Double Elbow	PTA533020	
M	25 - 30	with Single Elbow	PTA533308M	PTA533311M
		with Double Elbow	PTA533030	
L	30 - 38	with Single Elbow	PTA533308L	PTA533311L
		with Double Elbow	PTA533040	
XL	38 - 46	with Single Elbow	PTA533308XL	PTA533311XL
		with Double Elbow	PTA533050	

**Measurement:** All measurements are circumferences

## DermaSaver - Leg Garments



DVA: AR29



Size	Calf (cm)	Style (if applicable)	Leg Tube	Knee Tube	Shin Tube	Shin to Knee Tube
XS	18 - 23	with Single Knee	PTA533317	PTA533320	PTA533322	PTA533323
		with Double Knee	PTA533318	PTA533321		
S	23 - 30	with Single Knee	PTA533317S	PTA533320S	PTA533322S	PTA533323S
		with Double Knee	PTA533318S	PTA533321S		
M	30 - 38	with Single Knee	PTA533317M	PTA533320M	PTA533322M	PTA533323M
		with Double Knee	PTA533318M	PTA533321M		
L	38 - 48	with Single Knee	PTA533317L	PTA533320L	PTA533322L	PTA533323L
		with Double Knee	PTA533318L	PTA533321L		
XL	48 - 58	with Single Knee	PTA533317XL	PTA533320XL	PTA533322XL	PTA533323XL
		with Double Knee	PTA533318XL	PTA533321XL		

**Measurement:** All measurements are circumferences

## DermaSaver - Foot & Heel Garments



DVA: AR29



Size	Foot/Heel (cm)	Total Foot Protector	Stay-Put Heel Protector	Heel Elevator
XS	< 28	PTA533315	PTA533313	-
S	28 - 30	PTA533315S	PTA533313S	PTA533316
M	30 - 35	PTA533315M	PTA533313M	-
L	35 - 38	PTA533315L	PTA533313L	PTA533316L
XL	> 39	PTA533315XL	PTA533313XL	-

**Measurement:** All measurements are circumferences

### General Enquiries

P 1300 133 120 | E sales@aidacare.com.au | W www.aidacare.com.au



## DermaSaver - Ankle Garments



✓ DVA: AR29

Size	Ankle (cm)	Ankle Bumper
S	< 23	PTA533314
M	23 - 28	PTA533314M
L	28 - 33	PTA533314L
XL	> 33	PTA533314XL

**Measurement:** All measurements are circumferences

## DermaSaver - Amputee Stump Cover



✓ DVA: AR29

Size	Leg (cm)	Code
XS	20 - 25	PTA533319
S	25 - 30	PTA533319S
M	30 - 38	PTA533319M
L	38 - 45	PTA533319L
XL	45 - 56	PTA533319XL

**Measurement:** Around the leg, 5cm above amputation

## Protect-A-Limb - Limb & Skin Protectors



### Overview & Features:

Protect-A-Limb® protects the limbs from skin tears and skin damage.

- Protection against friction and impact
- Durable and comfortable to wear
- Constructed of Coolmax® fabric on the inner surface, and slightly retentive cotton on the outer surface
- Moisture wicking and prevents maceration
- Sealed ends prevent fraying
- Supplied as pairs

Size	Code	Size Guide
S	PTA491600	Suits arm and small leg
M	PTA491700	Suits arm and average lower leg
L	PTA491800	Full leg length

## Rolyan



### Overview

- Shock-absorbing gel padding: Effective following sudden injury or cumulative trauma injury to the elbow or heel
- Helps protect the joint by diffusing and distributing pressure
- Includes 6.4 mm shock-absorbing gel pad, which won't bottom out
- Sold in pairs

### To Order

Choose your preferred model, select your size and order using the appropriate code. For borderline measurements, choose the larger size for extra comfort.

## Heel/Elbow Protector - Gel



✓ DVA: AR29

Size	Code	Size Guide
S	PTA506400	Fits most small and medium women
M/L	PTA506500	Fits larger women and average-sized men
XL	PTA506600	Fits larger men



## GelBodies

### Overview

- Gel provides pressure-relieving skin protection and protection from pressure injury
- Uses a pressure-relieving gel found in high-end wheelchair cushions
- Cotton-lycra "coolband" stretches for ideal fit and feels great against the skin
- Machine washable
- Supplied as pairs



### To Order

Choose your preferred model, select your size and order using the appropriate code. For borderline measurements, choose the larger size for extra comfort.

### GelBodies - Heel & Elbow



DVA: AR29



Size	Heel or Elbow (cm)	Code
S	20 - 25	PTA533324
M	25 - 30	PTA533324M
L	30 - 36	PTA533324L
XL	36 - 41	PTA533324XL

**Measurement:** All measurements are circumferences

### GelBodies - Knee



DVA: AR29



Size	Knee (cm)	Code
S	23 - 28	PTA533325
M	28 - 33	PTA533325M
L	33 - 41	PTA533325L

**Measurement:** All measurements are circumferences

### GelBodies - Calf



DVA: AR29



Size	Calf (cm)	Code
M	25 - 33	PTA533326
L	30 - 41	PTA533326L

**Measurement:** All measurements are circumferences

### GelBodies - Ankle



DVA: AR29



Size	Ankle (cm)	Code
S	20 - 25	PTA533327
M	25 - 30	PTA533327M
L	30 - 36	PTA533327L

**Measurement:** All measurements are circumferences

# Compression - Legwear

**I ♥ ndis** For NDIS Item Code, refer to page: 508

## Purpose of Medical Stockings

- Improve blood flow in the lower limbs and assist in the prevention and management of venous disease
- Widely used to treat fluid build-up associated with lymphoedema
- Lymphoedema occurs if the lymphatic system is damaged or blocked. Excess fluid, which would normally be drained away by the lymphatics, builds up in the tissues (most commonly the arms or legs)
- Compression plays a major role in the treatment of lymphoedema by encouraging lymph flow

## Compression Values

- Medical stockings feature “graduated compression” - strongest at the ankle & progressively reducing up the leg
- Compression is measured in mmHg (millimetres of mercury compression) at the ankle
- Stockings < 20mmHg - (preventative): suitable for general leg relief, mild varicose veins, safeguard against DVT
- Stockings > 20mmHg - (therapeutic): more-serious or pre-existing conditions
- Stockings > 30 mmHg: medical professional prescription required

PREVENTATIVE	THERAPEUTIC		
15 - 20mmHg	20 - 30mmHg (class 1)	30 - 40mmHg (class 2)	40-50 mmHg (class 3)
Moderate <ul style="list-style-type: none"> <li>• Tired, aching legs</li> <li>• Mild varicose veins</li> <li>• Mild varicose veins during pregnancy</li> <li>• Mild fluid retention</li> <li>• Post sclerotherapy</li> <li>• Travel - for those with otherwise healthy legs</li> </ul>	Firm <ul style="list-style-type: none"> <li>• Mild/moderate varicose veins</li> <li>• Varicosities tending towards mild oedema</li> <li>• Varicose veins during and after pregnancy</li> <li>• Prevention of thrombosis (ambulatory)</li> <li>• Post sclerotherapy</li> </ul>	Extra Firm <ul style="list-style-type: none"> <li>• Mild chronic venous insufficiency</li> <li>• Moderate/severe varicosities during pregnancy</li> <li>• Phlebitis with mild oedema</li> <li>• After deep vein thrombosis</li> <li>• Diffuse varicosities</li> <li>• Varicose ulcers</li> <li>• Mild lymphoedema</li> </ul>	Strong <ul style="list-style-type: none"> <li>• Pronounced varicosities with oedema</li> <li>• Pronounced chronic venous insufficiency</li> <li>• After deep thrombophlebitis</li> <li>• Valvular insufficiency of the deep veins</li> <li>• Varicose ulcers &amp; lymphoedema</li> </ul>
<b>Contraindications</b>	Arteriopathy, hypodermatitis in acute state, wet dermatosis, cutaneous infections, unreduced oedema, acute thrombophlebitis.		

### DVA Contact Details

P 1300 888 052 | F 1300 787 052 | E [dva@aidacare.com.au](mailto:dva@aidacare.com.au)

**I ♥ ndis** For NDIS Item Code, refer to page: 508





DVA #	DVA Approval Needed?	DVA Approval Rules	Eligible Prescriber*
AR22	No (unless Aidacare advises)	Limit of 3 pairs every 6 months	S, RN, Physio, OT, LMO
DVA Comments	*For lymphoedema garments, health providers should have specialist post graduate training in oedema/lymphoedema management in order to access, measure, fit and review these garments.		

## Styles Available

- Closed-toe (full-foot, like a sock) - Most common. Appropriate with swelling of the foot/toes
- Open-toe (toes exposed) - Suitable where large foot size relative to leg measurement

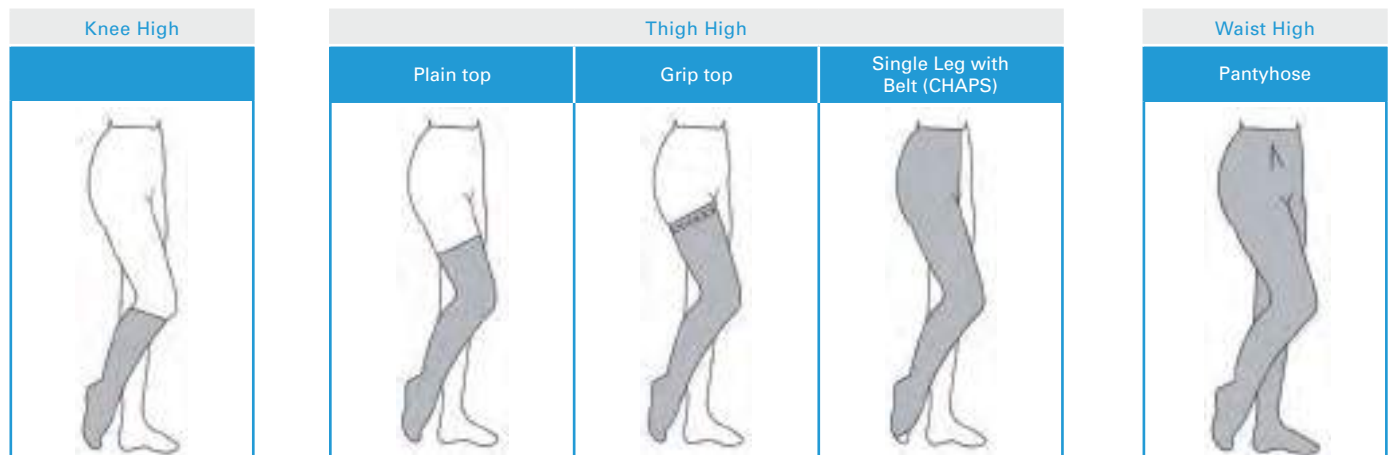

## Fitting & Selection Tips

- Correct measurement and sizing ARE VERY important
- Measurements should be taken first thing in the morning
- Cotton is best for sensitive skin
- Knee High - Ensure the top-band is flat against the leg, about 2 - 3cm below the knee crease. Do not allow the stocking to roll over at the top and never double the stocking over at the top if it seems too long
- Sizing Selection - Select size according to the largest measurement taken (eg. if ankle is 'small' and calf is 'medium', select the medium). If more than one size difference, contact Aidacare.

## Refer To Pages 480 For Donning And Doffing Aids



Sigvaris Doff N' Donner  
PTS642660



Jobst Donning Gloves  
FBS303490



Easy Slide 'Magnide' On /Off Aid (Closed Toe)  
PTS642512



## Dr. Comfort Diabetic Support Socks - Unisex (15 - 20mmHg)

- Diabetic support socks for men and women
- Helps to alleviate early lower limb conditions
- Prevents swelling in the legs, ankles and feet
- Compression: 15 - 20mmHg

### To Order

Choose your preferred model, then use the Size Guide to select the appropriate size and code

Size Guide				
Size	Ankle (cm)	Calf (cm)	Men's Shoe Size	Women's Shoe Size
Small	18 - 21	28 - 38	6 - 7.5	5 - 7
Medium	21 - 25	30 - 42	8 - 10	7.5 - 9.5
Large	25 - 29	32 - 46	10.5 - 12.5	10 - 12
X Large	29 - 33	34 - 50	13+	12.5+

Measurement: All measurements are circumferences. **Shoe Size** - USA sizes



DVA: AR22

Size	Colour	Code
Small	Black	PTS642502
	White	PTS642506
Medium	Black	PTS642501
	White	PTS642505
Large	Black	PTS642500
	White	PTS642504
X Large	Black	PTS642503
	White	PTS642507



## GloriaMed - Medical Legwear

### Overview

- Made in Italy, GloriaMed is one of the oldest and most respected manufacturers of compression legwear

### To Order

Choose your preferred model, then use the Size Guide to select the appropriate size and code

## GloriaMed - Stockings - Unisex

- GloriaMed stockings offer a choice of a **regular fit** or **wide fit** (good for when there is increased / excessive swelling)



DVA: AR22



Size Guide					
Size	Ankle (cm)	Below Knee		Upper Thigh	
		Regular Fit (cm)	Wide Fit (cm)	Regular Fit (cm)	Wide Fit (cm)
X Small	18 - 19	28 - 30	31 - 34	42 - 46	47 - 51
Small	20 - 22	31 - 34	35 - 38	47 - 51	52 - 57
Medium	23 - 25	35 - 38	39 - 42	52 - 57	58 - 63
Large	26 - 28	39 - 42	43 - 47	58 - 63	64 - 70
X Large	29 - 31	43 - 47	48 - 52	64 - 70	71 - 78

**Measurement:** All measurements are circumferences. **Ankle** - Narrowest part (just above ankle bone). **Below knee** - 2cm below knee. **Upper Thigh** - 5cm below groin **Note:** Thigh measurement relevant to thigh style only





## GloriaMed - Stockings - Unisex - Knee (Regular Fit)

- Available in soft, comfortable nylon OR hypoallergenic 100% cotton
- A choice of short (up to 38cm) or long (39cm+) lengths for a better fit
- Available in **beige only**



DVA: AR22

Size	Material	20 - 30mmHg		30 - 40mmHg		40 - 50mmHg
		Open Toe	Closed Toe	Open Toe	Closed Toe	Open Toe
<b>Short (up to 38cm)</b>						
X Small	Nylon	PTS641860XSRS	PTS641861XSRS	PTS641865XSRS	PTS641866XSRS	PTS641870XSRS
	Cotton	PTS641873XSRS	-	PTS641875XSRS	-	-
Small	Nylon	PTS641860SRS	PTS641861BE1SRS	PTS641865SRS	PTS641866BE1RS	PTS641870SRS
	Cotton	PTS641873SRS	-	PTS641875SRS	-	-
Medium	Nylon	PTS641860MRS	PTS641861BE2MRS	PTS641865MRS	PTS641866BE2MRS	PTS641870MRS
	Cotton	PTS641873MRS	-	PTS641875MRS	-	-
Large	Nylon	PTS641860LRS	PTS641861BE3LRS	PTS641865LRS	PTS641866BE3LRS	PTS641870LRS
	Cotton	PTS641873LRS	-	PTS641875LRS	-	-
X Large	Nylon	PTS641860XLRS	PTS641861BE4XLRS	PTS641865XLRS	PTS641866BE4XLRS	PTS641870XLRS
	Cotton	PTS641873XLRS	-	PTS641875XLRS	-	-
<b>Long (39cm+)</b>						
X Small	Nylon	PTS641860XSRL	PTS641861XSRL	PTS641865XSRL	PTS641866XSRL	PTS641870XSRL
	Cotton	PTS641873XSRL	-	PTS641875XSRL	-	-
Small	Nylon	PTS641860SRL	PTS641861BE1SRL	PTS641865SRL	PTS641866BE1SRL	PTS641870SRL
	Cotton	PTS641873SRL	-	PTS641875SRL	-	-
Medium	Nylon	PTS641860MRL	PTS641861BE2MRL	PTS641865MRL	PTS641866BE2MRL	PTS641870MRL
	Cotton	PTS641873MRL	-	PTS641875MRL	-	-
Large	Nylon	PTS641860LRL	PTS641861BE3LRL	PTS641865LRL	PTS641866BE3LRL	PTS641870LRL
	Cotton	PTS641873LRL	-	PTS641875LRL	-	-
X Large	Nylon	PTS641860XLRL	PTS641861BE4XLRL	PTS641865XLRL	PTS641866BE4XLRL	PTS641870XLRL
	Cotton	PTS641873XLRL	-	PTS641875XLRL	-	-

## GloriaMed - Stockings - Unisex - Knee (Wide Fit)

- Available in soft, comfortable nylon OR hypoallergenic 100% cotton
- A choice of short (up to 38cm) or long (39cm+) lengths for a better fit
- Wide fit will better accommodate increased / excessive swelling
- Available in **beige only**



DVA: AR22

Size	Material	20 - 30mmHg		30 - 40mmHg		40 - 50mmHg
		Open Toe	Closed Toe	Open Toe	Closed Toe	Open Toe
<b>Short (up to 38cm)</b>						
X Small	Nylon	PTS641860XSWS	PTS641861XSWS	PTS641865XSWS	PTS641866XSWS	PTS641870XSWS
	Cotton	PTS641873XSWS	-	PTS641875XSWS	-	-
Small	Nylon	PTS641860SWS	PTS641861BE1SWS	PTS641865SWS	PTS641866BE1SWS	PTS641870SWS
	Cotton	PTS641873SWS	-	PTS641875SWS	-	-
Medium	Nylon	PTS641860MWS	PTS641861BE2MWS	PTS641865MWS	PTS641866BE2MWS	PTS641870MWS
	Cotton	PTS641873MWS	-	PTS641875MWS	-	-
Large	Nylon	PTS641860LWS	PTS641861BE3LWS	PTS641865LWS	PTS641866BE3LWS	PTS641870LWS
	Cotton	PTS641873LWS	-	PTS641875LWS	-	-
X Large	Nylon	PTS641860XLWS	PTS641861BE4XLWS	PTS641865XLWS	PTS641866BE4XLWS	PTS641870XLWS
	Cotton	PTS641873XLWS	-	PTS641875XLWS	-	-
<b>Long (39cm+)</b>						
X Small	Nylon	PTS641860XSWL	PTS641861XSWL	PTS641865XSWL	PTS641866XSWL	PTS641870XSWL
	Cotton	PTS641873XSWL	-	PTS641875XSWL	-	-
Small	Nylon	PTS641860SWL	PTS641861BE1SWL	PTS641865SWL	PTS641866BE1SWL	PTS641870SWL
	Cotton	PTS641873SWL	-	PTS641875SWL	-	-
Medium	Nylon	PTS641860MWL	PTS641861BE2MWL	PTS641865MWL	PTS641866BE2MWL	PTS641870MWL
	Cotton	PTS641873MWL	-	PTS641875MWL	-	-
Large	Nylon	PTS641860LWL	PTS641861BE3LWL	PTS641865LWL	PTS641866BE3LWL	PTS641870LWL
	Cotton	PTS641873LWL	-	PTS641875LWL	-	-
X Large	Nylon	PTS641860XLWL	PTS641861BE4XLWL	PTS641865XLWL	PTS641866BE4XLWL	PTS641870XLWL
	Cotton	PTS641873XLWL	-	PTS641875XLWL	-	-



## GloriaMed - Stockings - Unisex - Thigh (Regular Fit)

- Available in soft comfortable **nylon**
- A choice of short (up to 71cm) or long (72cm+) lengths for a better fit
- Available in **beige only**



DVA: AR22

OPEN TOE ONLY								
20 - 30mmHg			30 - 40mmHg			40 - 50mmHg		
	Thigh high (Grip top)	Thigh Belt Top (Left)	Thigh Belt Top (Right)	Thigh high (Grip top)	Thigh Belt Top (Left)	Thigh Belt Top (Right)	Thigh Belt Top (Left)	Thigh Belt Top (Right)
Size	Short (up to 71cm)							
XS	PTS641863XSRS	PTS641864LXSRS	PTS641864RXSRS	PTS641868XSRS	PTS641869LXSRS	PTS641869RXSRS	PTS641871LXSRS	PTS641871RXSRS
S	PTS641863SRS	PTS641864LSRS	PTS641864RSRS	PTS641868SRS	PTS641869LSRS	PTS641869RSRS	PTS641871LSRS	PTS641871RSRS
M	PTS641863MRS	PTS641864LMRS	PTS641864RMRS	PTS641868MRS	PTS641869LMRS	PTS641869RMRS	PTS641871LMRS	PTS641871RMRS
L	PTS641863LRS	PTS641864LLRS	PTS641864RLRS	PTS641868LRS	PTS641869LLRS	PTS641869RLRS	PTS641871LLRS	PTS641871RLRS
XL	PTS641863XLR	PTS641864LXL	PTS641864RXL	PTS641868XLR	PTS641869LXL	PTS641869RXL	PTS641871LXL	PTS641871RXL
Size	Long (72cm+)							
XS	PTS641863XSRL	PTS641864LXSRL	PTS641864RXSRL	PTS641868XSRL	PTS641869LXSRL	PTS641869RXSRL	PTS641871LXSRL	PTS641871RXSRL
S	PTS641863SRL	PTS641864LSRL	PTS641864RSRL	PTS641868SRL	PTS641869LSRL	PTS641869RSRL	PTS641871LSRL	PTS641871RSRL
M	PTS641863MRL	PTS641864LMRL	PTS641864RMRL	PTS641868MRL	PTS641869LMRL	PTS641869RMRL	PTS641871LMRL	PTS641871RMRL
L	PTS641863LRL	PTS641864LLRL	PTS641864RLRL	PTS641868LRL	PTS641869LLRL	PTS641869RLRL	PTS641871LLRL	PTS641871RLRL
XL	PTS641863XLRL	PTS641864LXLRL	PTS641864RXLRL	PTS641868XLRL	PTS641869LXLRL	PTS641869RXLRL	PTS641871LXLRL	PTS641871RXLRL

## GloriaMed - Stockings - Unisex - Thigh (Wide Fit)

- Available in soft comfortable **nylon**
- A choice of short (up to 71cm) or long (72cm+) lengths for a better fit
- Wide fit will better accommodate increased / excessive swelling
- Available in **beige only**



DVA: AR22

OPEN TOE ONLY								
20 - 30mmHg			30 - 40mmHg			40 - 50mmHg		
	Thigh high (Grip top)	Thigh Belt Top (Left)	Thigh Belt Top (Right)	Thigh high (Grip top)	Thigh Belt Top (Left)	Thigh Belt Top (Right)	Thigh Belt Top (Left)	Thigh Belt Top (Right)
Size	Short (up to 71cm)							
XS	PTS641863XSWS	PTS641864LXSWS	PTS641864RXSWS	PTS641868XSWS	PTS641869LXSWS	PTS641869RXSWS	PTS641871LXSWS	PTS641871RXSWS
S	PTS641863SWS	PTS641864LSWS	PTS641864RSWS	PTS641868SWS	PTS641869LSWS	PTS641869RSWS	PTS641871LSWS	PTS641871RSWS
M	PTS641863MWS	PTS641864LMWS	PTS641864RMWS	PTS641868MWS	PTS641869LMWS	PTS641869RMWS	PTS641871LMWS	PTS641871RMWS
L	PTS641863LWS	PTS641864LLWS	PTS641864RLWS	PTS641868LWS	PTS641869LLWS	PTS641869RLWS	PTS641871LLWS	PTS641871RLWS
XL	PTS641863XLWS	PTS641864LXLWS	PTS641864RXLWS	PTS641868XLWS	PTS641869LXLWS	PTS641869RXLWS	PTS641871LXLWS	PTS641871RXLWS
Size	Long (72cm+)							
XS	PTS641863XSWL	PTS641864LXSWL	PTS641864RXSWL	PTS641868XSWL	PTS641869LXSWL	PTS641869RXSWL	PTS641871LXSWL	PTS641871RXSWL
S	PTS641863SWL	PTS641864LSWL	PTS641864RSWL	PTS641868SWL	PTS641869LSWL	PTS641869RSWL	PTS641871LSWL	PTS641871RSWL
M	PTS641863MWL	PTS641864LMWL	PTS641864RMWL	PTS641868MWL	PTS641869LMWL	PTS641869RMWL	PTS641871LMWL	PTS641871RMWL
L	PTS641863LWL	PTS641864LLWL	PTS641864RLWL	PTS641868LWL	PTS641869LLWL	PTS641869RLWL	PTS641871LLWL	PTS641871RLWL
XL	PTS641863XLWL	PTS641864LXLWL	PTS641864RXLWL	PTS641868XLWL	PTS641869LXLWL	PTS641869RXLWL	PTS641871LXLWL	PTS641871RXLWL





## GloriaMed - Micro Mesh - Pantyhose - Women



- Fashionable and sheer
- Suits all standard body shapes
- **Closed toe only**
- Available in **beige or black**
- Two compression classes available (20 - 30mmHg or 30 - 40mmHg)



DVA: AR22

Size Guide				20 - 30mmHg	30 - 40mmHg	
Size	Ankle (cm)	Below Knee (cm)	Upper Thigh (cm)	Code		
Small	20 - 21	31 - 34	52 - 57	Beige	PTS641877	PTS641878
				Black	PTS641877BL0	PTS641878BL0
Medium	22 - 23	33 - 36	55 - 60	Beige	PTS641877BE1	PTS641878BE1
				Black	PTS641877BL1	PTS641878BL1
Large	24 - 25	35 - 38	58 - 63	Beige	PTS641877BE2	PTS641878BE2
				Black	PTS641877BL2	PTS641878BL2
X Large	26 - 27	37 - 40	61 - 66	Beige	PTS641877BE3	PTS641878BE3
				Black	PTS641877BL3	PTS641878BL3

**Measurement:** All measurements are circumferences. **Ankle** - Narrowest part (just above ankle bone). **Below Knee** - 2cm below knee. **Upper Thigh** - 5cm below groin

## GloriaMed - Lady Gloria - Thigh - Women

- Attractive sheer and comfortable
- Suitable for young and dynamic women
- **Closed toe only**
- Available in **beige or black**
- Compression class available (15 - 20mmHg)

Height	Size Guide																			
	Weight (kg)																			
	45	48	50	52	54	60	59	61	64	66	68	70	73	75	77	79	81	84	86	88
150 cm																				
152 cm																				
155 cm																				
157 cm			1																	
160 cm																				
163 cm																				
165 cm																				
168 cm																				
170 cm																				
173 cm																				
175 cm																				
178 cm																				
180 cm																				
182 cm																				



**Measurement:** Determine size from the height / weight grid



DVA: AR22

Size	Colour	15 - 20mmHg
		Code
1	Beige	PTS641881
	Black	PTS641881BL1
2	Beige	PTS641881BE2
	Black	PTS641881BL2
3	Beige	PTS641881BE3
	Black	PTS641881BL3
4	Beige	PTS641881BE4
	Black	PTS641881BL4
5	Beige	PTS641881BE5
	Black	PTS641881BL5

### General Enquiries

P 1300 133 120 | E sales@aidacare.com.au | W www.aidacare.com.au



## IBICI - Medical Legwear



### Overview

- Designed and manufactured in Italy, IBICI's compression legwear range is ideal for mild vascular conditions, or as a preventative measure. All IBICI garments are **closed toe (full foot) only**

### To Order

Choose your preferred model, then use the Size Guide to select the appropriate size and code



### Segreta 140 & Segreta PLUS - Knee High - Women

- Segreta 140:** Fashionably sheer, in a range of colours and styles. **Closed toe only.** Compression: 15 - 20mmHg
- Segreta PLUS:** Comparable to 20 - 30, these give additional compression at the ankle. **Closed toe only.** Compression: 23 - 27mmHg



DVA: AR22

Size Guide					Segreta 140 (Knee high)	Segreta PLUS (Knee high)
					15 - 20mmHg	23 - 27mmHg
Size	Shoe Size	Ankle (cm)	Calf (cm)	Colour	Code	
1	34 - 35	17 - 20	28 - 38	Beige	PTS641879	PTS641885
				Black	PTS641879BL1	-
2	35 - 36	19 - 22	30 - 39	Beige	PTS641879BE2	PTS6418852
				Black	PTS641879BL2	-
3	37 - 38	20 - 24	31 - 40	Beige	PTS641879BE3	PTS6418853
				Black	PTS641879BL3	-
4	39 - 40	21 - 26	32 - 41	Beige	PTS641879BE4	PTS6418854
				Black	PTS641879BL4	-
5	41 - 42	22 - 28	33 - 42	Beige	PTS641879BE5	PTS6418855
				Black	PTS641879BL5	-
6	42 - 43	23 - 29	34 - 43	Beige	PTS641879BE6	-
				Black	PTS641879BL6	-

**Measurement: Shoe Size** - Metric European. All other measurements are circumferences. **Ankle** - Narrowest part (just above ankle bone). **Calf** - Widest part

### Segreta 140 & Segreta PLUS - Pantyhose - Women

- Segreta 140:** Fashionably sheer, in a range of colours and styles. **Closed toe only.** Compression: 15 - 20mmHg. Available in 5 regular sizes and 3 wider sizes (2W, 3W, 4W)
- Segreta PLUS:** Comparable to 20 - 30, these give additional compression at the ankle. The Segreta PLUS are semi-sheer. **Closed toe only.** Compression: 23 - 27mmHg. Available in 5 regular sizes only
- Maternity pantyhose are not on the DVA/RAP schedule

Height	Size Guide																	
	Weight (kg)																	
	40	44	48	52	56	60	64	68	72	76	80	84	88	92	96	100	104	108
150 cm	1									2W								
155 cm													3W					
160 cm			2														4W	
165 cm				3														
170 cm					4													
175 cm																		
180 cm																		
185 cm										5								
190 cm																		
195 cm																		

**Measurement:**

- First, determine size from the height/weight grid
- Then check that size against the ankle measurements on the Size Guide on the previous page
- If one measurement indicates a larger size than the other, select the larger size
- If more than 1 size difference, contact Aidacare for assistance



#### DVA Contact Details

P 1300 888 052 | F 1300 787 052 | E [dva@aidacare.com.au](mailto:dva@aidacare.com.au)



For NDIS Item Code, refer to page: 508





## Segreta 140 & Segreta PLUS - Pantyhose - Women (contd)



DVA: AR22

Size	Colour	Segreta 140 (Pantyhose - Regular Fit)	Segreta 140 (Pantyhose - Wider Fit)	Segreta PLUS (Pantyhose)
		15 - 20mmHg	15 - 20mmHg	23 - 27mmHg
		Code		
1	Beige	PTS641882	-	PTS641887
	Black	PTS641882BL1	-	-
2	Beige	PTS641882BE2	PTS641883BE2	PTS6418872
	Black	PTS641882BL2	-	-
3	Beige	PTS641882BE3	PTS641883BE3	PTS6418873
	Black	PTS641882BL3	-	-
4	Beige	PTS641882BE4	PTS641883BE4	PTS6418874
	Black	PTS641882BL4	-	-
5	Beige	PTS641882BE5	-	PTS6418875
	Black	PTS641882BL5	-	-

## SKYWALK - Knee High - Unisex (15 - 20mmHg)

- Designed as a travel sock, but also suitable for day-to-day wear for the prevention and relief of mild vascular conditions
- Similar to REPOMEN in appearance and compression, but featuring a high cotton content (33%) for added softness and comfort



DVA: AR22

Size Guide				15 - 20mmHg
Size	Ankle (cm)	Calf (cm)	Colour	Code
X Small	18 - 21	27 - 37	Black	PTS641889
Small	20 - 23	30 - 40	Black	PTS641889S
Medium	22 - 25	33 - 43	Black	PTS641889M
Large	24 - 27	36 - 46	Black	PTS641889L
X Large	26 - 29	39 - 49	Black	PTS641889XL



**Measurement:** All measurements are circumferences. **Ankle** - Narrowest part (just above ankle bone). **Calf** - Widest part

## REPOMEN - Knee High - Men (15 - 20mmHg)

- Has the stylish appearance of dress socks
- Two colours to choose from (**beige or black**)
- Compression: 15 - 20mmHg



DVA: AR22

Size Guide					15 - 20mmHg
Size	Shoe Size	Ankle (cm)	Calf (cm)	Colour	Code
X Small	37 - 38	18 - 21	30 - 40	Beige	PTS641888
				Black	PTS641888BLXS
Small	39 - 40	20 - 23	32 - 42	Beige	PTS641888BES
				Black	PTS641888BLS
Medium	41 - 42	21 - 25	33 - 43	Beige	PTS641888BEM
				Black	PTS641888BLM
Large	43 - 44	22 - 27	34 - 46	Beige	PTS641888BEL
				Black	PTS641888BLL
X Large	45 - 46	23 - 28	35 - 48	Beige	PTS641888BEXL
				Black	PTS641888BLXL

**Measurement:** **Shoe Size** - Metric European. All other measurements are circumferences. **Ankle** - Narrowest part (just above ankle bone). **Calf** - Widest part

### General Enquiries

P 1300 133 120 | E sales@aidacare.com.au | W www.aidacare.com.au



## Jobst - Medical Legwear



### Overview

- Jobst stockings focus on improving the quality of life for those suffering from venous and lymphatic diseases

### To Order

Choose your preferred model, then use the Size Guide to select the appropriate size and code

### Size Guide

#### KNEE HIGH:

Sizing is the same for all Jobst knee high stockings, but there are an additional 2 larger sizes in the 'Relief' knee high range.

Take the ankle and calf measurements to determine size:

- Ankle - the narrowest point of the ankle, immediately above the ankle bone
- Calf - the widest part of the lower leg

#### THIGH & WAIST HIGH:

In addition to ankle and calf measurements.

- Take the measurement around the top of the leg (groin)
- The waist high (pantyhose), also require a hip measurement

	Small	Medium	Large	X Large	L full calf 'Relief' Only	XL full calf 'Relief' Only
Ankle (cm)	18 - 21	21 - 25	25 - 29	29 - 33	25 - 30	30 - 36
Calf (cm)	28 - 38	30 - 42	32 - 46	34 - 50	46 - 61	46 - 61
Groin (cm)	40 - 62	46 - 70	54 - 78	60 - 81	-	-
Hip (cm)	71 - 117	76 - 127	81 - 137	102 - 166	-	-

**Measurement:** All measurements are circumferences.

### Jobst UltraSheer for Women

- Sheer, comfortable and shaped for women. These are **closed toe only** stockings
- The UltraSheer range is available in knee high, thigh high and waist high styles



DVA: AR22



		CLOSED TOE ONLY								
		15 - 20mmHg			20 - 30mmHg			30 - 40mmHg		
		Knee high	Thigh high (Grip top)	Waist high (Pantyhose)	Knee high	Thigh high (Grip top)	Waist high (Pantyhose)	Knee high	Thigh high (Grip top)	Waist high (Pantyhose)
Size	Colour	Code								
Small	Black	PTS640140	PTS640330B	PTS640380	PTS640610	PTS640710	PTS640779	PTS640870	PTS640945	PTS640983
	Natural	PTS640220	PTS640330	PTS640450	PTS640650	PTS640740	PTS640789	PTS640910	PTS640949	PTS640969
Medium	Black	PTS640150	PTS640300	PTS640390	PTS640620	PTS640720	PTS640780	PTS640880	PTS640946	PTS640984
	Natural	PTS640230	PTS640335	PTS640460	PTS640660	PTS640750	PTS640790	PTS640920	PTS640950	PTS640970
Large	Black	PTS640160	PTS640310	PTS640400	PTS640630	PTS640730	PTS640781	PTS640890	PTS640947	PTS640985
	Natural	PTS640240	PTS640350	PTS640470	PTS640670	PTS640760	PTS640800	PTS640930	PTS640955	PTS640980
X Large	Black	PTS640170	PTS640315	PTS640410	PTS640640	PTS640735	PTS640782	PTS640900	PTS640948	PTS640986
	Natural	PTS640250	PTS640360	PTS640480	PTS640680	PTS640761	PTS640810	PTS640940	PTS640960	PTS640981

### Jobst for Men

- Comfortable, lightweight and stylish ribbed design. These are **closed-toe only** stockings of nylon fabric
- The Jobst for Men range is available in knee high or thigh high styles



DVA: AR22



		CLOSED TOE ONLY				
		15 - 20mmHg	20 - 30mmHg		30 - 40mmHg	
		Knee high	Knee high	Thigh high (Grip top)	Knee high	Thigh high (Grip top)
Size	Colour	Code				
Small	Black	PTS640040	PTS640530	PTS640601	PTS640830	PTS640605
Medium	Black	PTS640050	PTS640540	PTS640602	PTS640840	PTS640606
Large	Black	PTS640060	PTS640550	PTS640603	PTS640850	PTS640607
X Large	Black	PTS640070	PTS640560	PTS640604	PTS640860	PTS640608

#### DVA Contact Details

P 1300 888 052 | F 1300 787 052 | E [dva@aidacare.com.au](mailto:dva@aidacare.com.au)



For NDIS Item Code, refer to page: 508







## Jobst Relief - Unisex - Knee High

- A more durable range, with compression values from 15 - 20mmHg to 30 - 40mmHg
- Available in **open or closed toe**



DVA: AR22

Size	Colour	15 - 20mmHg		20 - 30mmHg		30 - 40mmHg	
		Open Toe	Closed Toe	Open Toe	Closed Toe	Open Toe	Closed Toe
Small	Beige	PTS642516	PTS642522	PTS641150	PTS641110	PTS641190	-
	Black	-	-	-	-	-	-
Medium	Beige	PTS642517	PTS642523	PTS641160	PTS641120	PTS641200	PTS641240
	Black	-	-	-	-	-	-
Large	Beige	PTS642518	PTS642524	PTS641170	PTS641130	PTS641210	PTS641250
	Black	-	-	-	-	-	-
X Large	Beige	PTS642519	PTS642525	PTS641180	PTS641140	PTS641220	PTS641260
	Black	-	-	-	-	-	-
Large (full calf)	Beige	PTS642520	PTS642526	PTS641181	PTS641141	PTS641221	PTS641261
	Black	-	-	-	-	-	-
X Large (full calf)	Beige	PTS642521	PTS642527	PTS641182	PTS641142	PTS641222	PTS641262
	Black	-	-	-	-	-	-

## Jobst Relief - Unisex - Thigh High (Grip Top)

- A more durable range, with compression values from 20 - 30mmHg to 30 - 40mmHg
- Available in **open or closed toe**



DVA: AR22

Size	Colour	20 - 30mmHg		30 - 40mmHg	
		Open Toe	Closed Toe	Open Toe	Closed Toe
Small	Beige	PTS641300	PTS641265	PTS641940	PTS641944
Medium	Beige	PTS641270	PTS641310	PTS641941	PTS641945
Large	Beige	PTS641280	PTS641319	PTS641942	PTS641946
X Large	Beige	PTS641290	PTS641320	PTS641943	PTS642264



## Jobst Relief - Unisex - Chaps

- A more durable range, with compression values from 20 - 30mmHg to 30 - 40mmHg



DVA: AR22

Size	Colour	OPEN TOE ONLY			
		20 - 30mmHg		30 - 40mmHg	
		Left	Right	Left	Right
Small	Beige	PTS641349	PTS641359	PTS641371	PTS641374
Medium	Beige	PTS641351	PTS641360	PTS641380	PTS641375
Large	Beige	PTS641352	PTS641365	PTS641372	PTS641376
X Large	Beige	PTS641350	PTS641370	PTS641373	PTS641377



## Jobst Relief - Unisex - Pantyhose

- A more durable range, with compression values from 20 - 30mmHg to 30 - 40mmHg
- Available in **open or closed toe**



DVA: AR22

Size	Colour	20 - 30mmHg		30 - 40mmHg	
		Open Toe	Closed Toe	Open Toe	Closed Toe
Small	Beige	PTS641339	PTS641938	PTS641947	-
Medium	Beige	PTS641340	PTS641330	PTS641948	-
Large	Beige	PTS641341	PTS641939	PTS641949	-
X Large	Beige	PTS641342	PTS641335	PTS641950	-





## Jobst 'UlcerCare' (40mmHg)

- Designed to help in the healing of venous leg ulcers, the Jobst UlcerCare two-stocking system provides the gradient compression required for a venous ulcer to heal
- Starter Kit includes:** stocking and 2 liners. Replacement Liners come in a 3 pack
- Important: Ensure the zipper is on the opposite side to the wound



DVA: AR22

Size Guide			Starter Kit (Left Zip)	Starter Kit (Right Zip)	Replacement Liners
Size	Ankle (cm)	Calf (cm)	Code		
Small	18 - 21	29 - 35	PTS641951	PTS640990	PTS641025
Medium	21 - 24	34 - 41	PTS641952	PTS641000	PTS641030
Large	24 - 27	40 - 47	PTS641953	PTS641010	PTS641040
X Large	27 - 30	46 - 54	PTS641954	PTS641020	PTS641031
XX Large	30 - 33	48 - 56	PTS641955	PTS641021	PTS641032

**Measurement:** All measurements are circumferences.

## Jobst Travel Socks - Unisex

- These socks help reduce the health risk associated with long distance travel
- They prevent swollen ankles and feet and reduce the risk of traveller's thrombosis
- Circulation is improved and legs feel great during and after travelling



DVA: AR22

Size	Colour	Code
1	Beige	PTS640026
	Black	PTS640021
2	Beige	PTS640027
	Black	PTS640022
3	Beige	PTS640028
	Black	PTS640023
4	Beige	PTS640029
	Black	PTS640024
5	Beige	PTS640030
	Black	PTS640025



### TRAVEL COMPRESSION SOCK SIZES

#### CIRCUMFERENCE (cm)

Size	I	II	III	IV	V
Calf	27 - 37	30 - 40	33 - 43	36 - 46	39 - 49
Ankle	18 - 21	20 - 23	22 - 25	24 - 27	26 - 29

## Mediven - Medical Legwear

### Overview

- Mediven offer a variety of compression stockings in a choice of colours and styles to suit a wide range of users



### To Order

Choose your preferred model, then use the Size Guide to select the appropriate size and code

### Size Guide

Take circumferential measurements to determine size (thigh measurement only needed for thigh and waist high stockings)

#### MEDIVEN ELEGANCE - MEDIVEN COMFORT - MEDIVEN PLUS (UNISEX)

##### CIRCUMFERENCE (cm)

Size	I	II	III	IV	V	VI	VII
Ankle	18 - 20	20 - 22	22 - 24	24 - 26	26 - 28	28 - 30	30 - 32
Calf	28 - 34	30 - 37	33 - 40	35 - 43	37 - 46	39 - 49	41 - 51
Below knee	27 - 33	29 - 36	32 - 39	34 - 42	36 - 45	38 - 48	40 - 50
Thigh - plain top	43 - 57	45 - 62	49 - 67	53 - 72	56 - 77	60 - 81	64 - 85
Thigh - grip top	43 - 48	45 - 52	49 - 56	53 - 60	56 - 64	60 - 68	64 - 72

**Measurement:** All measurements are circumferences. **Ankle** - Narrowest part (just above ankle bone). **Calf** - Widest part. **Below Knee** - 2cm below knee. **Thigh** - 5cm below groin

**Note:** Thigh measurement relevant for thigh, pantyhose and chaps styles only

### DVA Contact Details

P 1300 888 052 | F 1300 787 052 | E [dva@aidacare.com.au](mailto:dva@aidacare.com.au)



For NDIS Item Code,  
refer to page: 508





## Mediven - Elegance Series - Knee High

- Sheer, elegant, fashionable and versatile
- Suitable for the female wearer
- Available in short or regular sizes
- Available in **beige only**



DVA: AR22

CLOSED TOE ONLY		
	20 - 30mmHg	30 - 40mmHg
Size	Short (34 - 38cm)	
I	PTS642001	PTS642003
II	PTS642001BEII	PTS642003BEII
III	PTS642001BEIII	PTS642003BEIII
IV	PTS642001BEIV	PTS642003BEIV
V	PTS642001BEV	PTS642003BEV
VI	PTS642001BEVI	PTS642003BEVI
VII	PTS642001BEVII	PTS642003BEVII
Size	Regular (39 - 44cm)	
I	PTS642000	PTS642002
II	PTS642000BEII	PTS642002BEII
III	PTS642000BEIII	PTS642002BEIII
IV	PTS642000BEIV	PTS642002BEIV
V	PTS642000BEV	PTS642002BEV
VI	PTS642000BEVI	PTS642002BEVI
VII	PTS642000BEVII	PTS642002BEVII



**Measurement:** To determine Short or Regular, measure from the floor to 2cm below the knee

## Mediven - Elegance Series - Thigh High

- Sheer, elegant, fashionable and versatile
- Suitable for the female wearer
- Available in short or regular sizes
- Available in **beige only**



DVA: AR22

CLOSED TOE ONLY				
	20 - 30mmHg		30 - 40mmHg	
Size	Short (62 - 71cm)			
	Plain Top	Grip Top	Plain Top	Grip Top
I	PTS642005	PTS642009	PTS642007	PTS642011
II	PTS642005BEII	PTS642009BEII	PTS642007BEII	PTS642011BEII
III	PTS642005BEIII	PTS642009BEIII	PTS642007BEIII	PTS642011BEIII
IV	PTS642005BEIV	PTS642009BEIV	PTS642007BEIV	PTS642011BEIV
V	PTS642005BEV	PTS642009BEV	PTS642007BEV	PTS642011BEV
VI	PTS642005BEVI	PTS642009BEVI	PTS642007BEVI	PTS642011BEVI
VII	PTS642005BEVII	PTS642009BEVII	PTS642007BEVII	PTS642011BEVII
Size	Regular (72 - 83cm)			
	Plain Top	Grip Top	Plain Top	Grip Top
I	PTS642004	PTS642008	PTS642006	PTS642010
II	PTS642004BEII	PTS642008BEII	PTS642006BEII	PTS642010BEII
III	PTS642004BEIII	PTS642008BEIII	PTS642006BEIII	PTS642010BEIII
IV	PTS642004BEIV	PTS642008BEIV	PTS642006BEIV	PTS642010BEIV
V	PTS642004BEV	PTS642008BEV	PTS642006BEV	PTS642010BEV
VI	PTS642004BEVI	PTS642008BEVI	PTS642006BEVI	PTS642010BEVI
VII	PTS642004BEVII	PTS642008BEVII	PTS642006BEVII	PTS642010BEVII



**Measurement:** To determine Short or Regular, measure from the floor to 5cm below the groin

### General Enquiries

P 1300 133 120 | E sales@aidacare.com.au | W www.aidacare.com.au



## Mediven - Elegance Series - Pantyhose

- Sheer, elegant, fashionable and versatile
- Suitable for the female wearer
- Available in short or regular sizes
- Available in **beige only**



DVA: AR22

CLOSED TOE ONLY			
		20 - 30mmHg	30 - 40mmHg
Size	Short (62 - 71cm)		
I	PTS642013		PTS642015
II	PTS642013II		PTS642015II
III	PTS642013III		PTS642015III
IV	PTS642013IV		PTS642015IV
V	PTS642013V		PTS642015V
VI	PTS642013VI		PTS642015VI
VII	PTS642013VII		PTS642015VII
Size	Regular (72 - 83cm)		
I	PTS642012		PTS642014
II	PTS642012BEII		PTS642014II
III	PTS642012BEIII		PTS642014III
IV	PTS642012BEIV		PTS642014IV
V	PTS642012BEV		PTS642014V
VI	PTS642012BEVI		PTS642014VI
VII	PTS642012BEVII		PTS642014VII



**Measurement:** To determine Short or Regular, measure from the floor to 5cm below the groin

## Mediven - Comfort Series - Knee High

- Highly elasticised opaque knit - comfortable to wear
- Available in **beige only**
- Suitable for both males and females
- Two compression options



DVA: AR22

		20 - 30mmHg		30 - 40mmHg	
Size	Short (34 - 38cm)				
	Open Toe	Closed Toe	Open Toe	Closed Toe	
I	PTS642019	PTS642017	PTS642035	PTS642033	
II	PTS642019BEII	PTS642017BEII	PTS642035BEII	PTS642033BEII	
III	PTS642019BEIII	PTS642017BEIII	PTS642035BEIII	PTS642033BEIII	
IV	PTS642019BEIV	PTS642017BEIV	PTS642035BEIV	PTS642033BEIV	
V	PTS642019BEV	PTS642017BEV	PTS642035BEV	PTS642033BEV	
VI	PTS642019BEVI	PTS642017BEVI	PTS642035BEVI	PTS642033BEVI	
VII	PTS642019BEVII	PTS642017BEVII	PTS642035BEVII	PTS642033BEVII	
Size	Regular (39 - 44cm)				
	Open Toe	Closed Toe	Open Toe	Closed Toe	
I	PTS642018	PTS642016	PTS642034	PTS642032	
II	PTS642018BEII	PTS642016BEII	PTS642034BEII	PTS642032BEII	
III	PTS642018BEIII	PTS642016BEIII	PTS642034BEIII	PTS642032BEIII	
IV	PTS642018BEIV	PTS642016BEIV	PTS642034BEIV	PTS642032BEIV	
V	PTS642018BEV	PTS642016BEV	PTS642034BEV	PTS642032BEV	
VI	PTS642018BEVI	PTS642016BEVI	PTS642034BEVI	PTS642032BEVI	
VII	PTS642018BEVII	PTS642016BEVII	PTS642034BEVII	PTS642032BEVII	



**Measurement:** To determine Short or Regular, measure from the floor to 2cm below the knee

### DVA Contact Details

P 1300 888 052 | F 1300 787 052 | E [dva@aidacare.com.au](mailto:dva@aidacare.com.au)



For NDIS Item Code, refer to page: 508



## Mediven - Comfort Series - Thigh High (Grip Top)

- Highly elasticised opaque knit - comfortable to wear
- Available in **beige only**
- Suitable for both males and females
- Two compression options



Size	20 - 30mmHg		30 - 40mmHg	
	Short (62 - 71cm)			
	Open Toe	Closed Toe	Open Toe	Closed Toe
I	PTS642023	PTS642021	PTS642039	PTS642037
II	PTS642023BEII	PTS642021BEII	PTS642039BEII	PTS642037BEII
III	PTS642023BEIII	PTS642021BEIII	PTS642039BEIII	PTS642037BEIII
IV	PTS642023BEIV	PTS642021BEIV	PTS642039BEIV	PTS642037BEIV
V	PTS642023BEV	PTS642021BEV	PTS642039BEV	PTS642037BEV
VI	PTS642023BEVI	PTS642021BEVI	PTS642039BEVI	PTS642037BEVI
VII	PTS642023BEVII	PTS642021BEVII	PTS642039BEVII	PTS642037BEVII
Size	Regular (72 - 83cm)			
	Open Toe	Closed Toe	Open Toe	Closed Toe
I	PTS642022	PTS642020	PTS642038	PTS642036
II	PTS642022BEII	PTS642020BEII	PTS642038BEII	PTS642036BEII
III	PTS642022BEIII	PTS642020BEIII	PTS642038BEIII	PTS642036BEIII
IV	PTS642022BEIV	PTS642020BEIV	PTS642038BEIV	PTS642036BEIV
V	PTS642022BEV	PTS642020BEV	PTS642038BEV	PTS642036BEV
VI	PTS642022BEVI	PTS642020BEVI	PTS642038BEVI	PTS642036BEVI
VII	PTS642022BEVII	PTS642020BEVII	PTS642038BEVII	PTS642036BEVII



**Measurement:** To determine Short or Regular, measure from the floor to 5cm below the groin

## Mediven - Comfort Series - Pantyhose

- Highly elasticised opaque knit - comfortable to wear
- Available in **beige only**
- Suitable for both males and females
- Two compression options



Size	20 - 30mmHg		30 - 40mmHg	
	Short (62 - 71cm)			
	Open Toe	Closed Toe	Open Toe	Closed Toe
I	PTS642031	PTS642029	PTS642047	PTS642045
II	PTS642031BEII	PTS642029BEII	PTS642047BEII	PTS642045BEII
III	PTS642031BEIII	PTS642029BEIII	PTS642047BEIII	PTS642045BEIII
IV	PTS642031BEIV	PTS642029BEIV	PTS642047BEIV	PTS642045BEIV
V	PTS642031BEV	PTS642029BEV	PTS642047BEV	PTS642045BEV
VI	PTS642031BEVI	PTS642029BEVI	PTS642047BEVI	PTS642045BEVI
VII	PTS642031BEVII	PTS642029BEVII	PTS642047BEVII	PTS642045BEVII
Size	Regular (72 - 83cm)			
	Open Toe	Closed Toe	Open Toe	Closed Toe
I	PTS642030	PTS642028	PTS642046	PTS642044
II	PTS642030BEII	PTS642028BEII	PTS642046BEII	PTS642044BEII
III	PTS642030BEIII	PTS642028BEIII	PTS642046BEIII	PTS642044BEIII
IV	PTS642030BEIV	PTS642028BEIV	PTS642046BEIV	PTS642044BEIV
V	PTS642030BEV	PTS642028BEV	PTS642046BEV	PTS642044BEV
VI	PTS642030BEVI	PTS642028BEVI	PTS642046BEVI	PTS642044BEVI
VII	PTS642030BEVII	PTS642028BEVII	PTS642046BEVII	PTS642044BEVII



**Measurement:** To determine Short or Regular, measure from the floor to 5cm below the groin

### General Enquiries

P 1300 133 120 | E sales@aidacare.com.au | W www.aidacare.com.au



## Mediven - Plus Series - Knee High

- Soft but durable with antibacterial action for fresher feet
- Available in **beige only**
- Suitable for both males and females
- Three compression options available



DVA: AR22

OPEN TOE ONLY			
	20 - 30mmHg	30 - 40mmHg	40 - 50mmHg
<b>Size</b>	<b>Short (34 - 38cm)</b>		
I	PTS642051	PTS642052	PTS642053
II	PTS642051BEII	PTS642052BEII	PTS642053BEII
III	PTS642051BEIII	PTS642052BEIII	PTS642053BEIII
IV	PTS642051BEIV	PTS642052BEIV	PTS642053BEIV
V	PTS642051BEV	PTS642052BEV	PTS642053BEV
VI	PTS642051BEVI	PTS642052BEVI	PTS642053BEVI
VII	PTS642051BEVII	PTS642052BEVII	PTS642053BEVII
<b>Size</b>	<b>Regular (39 - 44cm)</b>		
I	PTS642048	PTS642049	PTS642050
II	PTS642048BEII	PTS642049BEII	PTS642050BEII
III	PTS642048BEIII	PTS642049BEIII	PTS642050BEIII
IV	PTS642048BEIV	PTS642049BEIV	PTS642050BEIV
V	PTS642048BEV	PTS642049BEV	PTS642050BEV
VI	PTS642048BEVI	PTS642049BEVI	PTS642050BEVI
VII	PTS642048BEVII	PTS642049BEVII	PTS642050BEVII



**Measurement:** To determine Short or Regular, measure from the floor to 2cm below the knee

## Mediven - Plus Series - Thigh High

- Soft but durable with antibacterial action for fresher feet
- Available in **beige only**
- Choice of Plain Top or Grip Top
- Three compression options available



DVA: AR22

OPEN TOE ONLY						
	20 - 30mmHg		30 - 40mmHg		40 - 50mmHg	
<b>Size</b>	<b>Short (62 - 71cm)</b>					
	Plain Top	Grip Top	Plain Top	Grip Top	Plain Top	Grip Top
I	PTS642059	PTS642065	PTS642060	PTS642066	PTS642061	PTS642067
II	PTS642059BEII	PTS642065BEII	PTS642060BEII	PTS642066BEII	PTS642061BEII	PTS642067BEII
III	PTS642059BEIII	PTS642065BEIII	PTS642060BEIII	PTS642066BEIII	PTS642061BEIII	PTS642067BEIII
IV	PTS642059BEIV	PTS642065BEIV	PTS642060BEIV	PTS642066BEIV	PTS642061BEIV	PTS642067BEIV
V	PTS642059BEV	PTS642065BEV	PTS642060BEV	PTS642066BEV	PTS642061BEV	PTS642067BEV
VI	PTS642059BEVI	PTS642065BEVI	PTS642060BEVI	PTS642066BEVI	PTS642061BEVI	PTS642067BEVI
VII	PTS642059BEVII	PTS642065BEVII	PTS642060BEVII	PTS642066BEVII	PTS642061BEVII	PTS642067BEVII
<b>Size</b>	<b>Regular (72 - 83cm)</b>					
	Plain Top	Grip Top	Plain Top	Grip Top	Plain Top	Grip Top
I	PTS642056	PTS642062	PTS642057	PTS642063	PTS642058	PTS642064
II	PTS642056BEII	PTS642062BEII	PTS642057BEII	PTS642063BEII	PTS642058BEII	PTS642064BEII
III	PTS642056BEIII	PTS642062BEIII	PTS642057BEIII	PTS642063BEIII	PTS642058BEIII	PTS642064BEIII
IV	PTS642056BEIV	PTS642062BEIV	PTS642057BEIV	PTS642063BEIV	PTS642058BEIV	PTS642064BEIV
V	PTS642056BEV	PTS642062BEV	PTS642057BEV	PTS642063BEV	PTS642058BEV	PTS642064BEV
VI	PTS642056BEVI	PTS642062BEVI	PTS642057BEVI	PTS642063BEVI	PTS642058BEVI	PTS642064BEVI
VII	PTS642056BEVII	PTS642062BEVII	PTS642057BEVII	PTS642063BEVII	PTS642058BEVII	PTS642064BEVII

**Measurement:** To determine Short or Regular, measure from the floor to 5cm below the groin

### DVA Contact Details

P 1300 888 052 | F 1300 787 052 | E [dva@aidacare.com.au](mailto:dva@aidacare.com.au)



For NDIS Item Code,  
refer to page: 508



## Mediven - Plus Series - Chaps

- Soft but durable with antibacterial action for fresher feet
- Available in **beige only**
- Choose between left or right for adequate fit
- Three compression options available



DVA: AR22

OPEN TOE ONLY						
20 - 30mmHg		30 - 40mmHg		40 - 50mmHg		
Size	Short (62 - 71cm)					
	Left	Right	Left	Right	Left	Right
I	PTS642071	PTS642077	PTS642072	PTS642078	PTS642073	PTS642079
II	PTS642071BEII	PTS642077BEII	PTS642072BEII	PTS642078BEII	PTS642073BEII	PTS642079BEII
III	PTS642071BEIII	PTS642077BEIII	PTS642072BEIII	PTS642078BEIII	PTS642073BEIII	PTS642079BEIII
IV	PTS642071BEIV	PTS642077BEIV	PTS642072BEIV	PTS642078BEIV	PTS642073BEIV	PTS642079BEIV
V	PTS642071BEV	PTS642077BEV	PTS642072BEV	PTS642078BEV	PTS642073BEV	PTS642079BEV
VI	PTS642071BEVI	PTS642077BEVI	PTS642072BEVI	PTS642078BEVI	PTS642073BEVI	PTS642079BEVI
VII	PTS642071BEVII	PTS642077BEVII	PTS642072BEVII	PTS642078BEVII	PTS642073BEVII	PTS642079BEVII
Size	Regular (72 - 83cm)					
	Left	Right	Left	Right	Left	Right
I	PTS642068	PTS642074	PTS642069	PTS642075	PTS642070	PTS642076
II	PTS642068BEII	PTS642074BEII	PTS642069BEII	PTS642075BEII	PTS642070BEII	PTS642076BEII
III	PTS642068BEIII	PTS642074BEIII	PTS642069BEIII	PTS642075BEIII	PTS642070BEIII	PTS642076BEIII
IV	PTS642068BEIV	PTS642074BEIV	PTS642069BEIV	PTS642075BEIV	PTS642070BEIV	PTS642076BEIV
V	PTS642068BEV	PTS642074BEV	PTS642069BEV	PTS642075BEV	PTS642070BEV	PTS642076BEV
VI	PTS642068BEVI	PTS642074BEVI	PTS642069BEVI	PTS642075BEVI	PTS642070BEVI	PTS642076BEVI
VII	PTS642068BEVII	PTS642074BEVII	PTS642069BEVII	PTS642075BEVII	PTS642070BEVII	PTS642076BEVII

**Measurement:** To determine Short or Regular, measure from the floor to 5cm below the groin

## Mediven - Plus Series - Pantyhose

- Soft but durable with antibacterial action for fresher feet
- Available in **beige only**
- Three compression options available



DVA: AR22

OPEN TOE ONLY						
20 - 30mmHg		30 - 40mmHg		40 - 50mmHg		
Size	Short (62 - 71cm)					
	Left	Right	Left	Right	Left	Right
I	PTS642083	PTS642084	PTS642083	PTS642084	PTS642085	PTS642086
II	PTS642083BEII	PTS642084BEII	PTS642083BEII	PTS642084BEII	PTS642085BEII	PTS642086BEII
III	PTS642083BEIII	PTS642084BEIII	PTS642083BEIII	PTS642084BEIII	PTS642085BEIII	PTS642086BEIII
IV	PTS642083BEIV	PTS642084BEIV	PTS642083BEIV	PTS642084BEIV	PTS642085BEIV	PTS642086BEIV
V	PTS642083BEV	PTS642084BEV	PTS642083BEV	PTS642084BEV	PTS642085BEV	PTS642086BEV
VI	PTS642083BEVI	PTS642084BEVI	PTS642083BEVI	PTS642084BEVI	PTS642085BEVI	PTS642086BEVI
VII	PTS642083BEVII	PTS642084BEVII	PTS642083BEVII	PTS642084BEVII	PTS642085BEVII	PTS642086BEVII
Size	Regular (72 - 83cm)					
	Left	Right	Left	Right	Left	Right
I	PTS642080	PTS642081	PTS642080	PTS642081	PTS642082	PTS642083
II	PTS642080BEII	PTS642081BEII	PTS642080BEII	PTS642081BEII	PTS642082BEII	PTS642083BEII
III	PTS642080BEIII	PTS642081BEIII	PTS642080BEIII	PTS642081BEIII	PTS642082BEIII	PTS642083BEIII
IV	PTS642080BEIV	PTS642081BEIV	PTS642080BEIV	PTS642081BEIV	PTS642082BEIV	PTS642083BEIV
V	PTS642080BEV	PTS642081BEV	PTS642080BEV	PTS642081BEV	PTS642082BEV	PTS642083BEV
VI	PTS642080BEVI	PTS642081BEVI	PTS642080BEVI	PTS642081BEVI	PTS642082BEVI	PTS642083BEVI
VII	PTS642080BEVII	PTS642081BEVII	PTS642080BEVII	PTS642081BEVII	PTS642082BEVII	PTS642083BEVII

**Measurement:** To determine Short or Regular, measure from the floor to 5cm below the groin





## Sigvaris

### To Order

Choose your preferred model. Then, order using: Code, Description, Styles, Compression (mmHg), Size

SIGVARIS

### Sigvaris - Cotton - Unisex

- Particularly suitable for users with sensitive skin
- Colour available: **Natural**
- The mix of fibres also ensures that the stocking slides on and off easily



Size Guide				
Size	Ankle (cm)	Below Knee (cm) (Calf)	Upper Thigh (cm) (Thigh Grip Tops)	Upper Thigh (cm) (Pantyhose & Chaps)
XS	20 - 22	27 - 34	47 - 56	47 - 56
S	22 - 24	31 - 38	52 - 61	52 - 64
M	24 - 26	34 - 41	56 - 65	56 - 68
L	26 - 29	37 - 44	61 - 71	61 - 74

**Measurement:** All measurements are circumferences. **Ankle** - Narrowest part (just above ankle bone).  
**Below Knee** - 2cm below knee. **Upper Thigh** - 5cm below groin



DVA: AR22

Code	Description	Style	Compression (mmHg)			Size
			18 - 21 (Class 1)	23 - 32 (Class 2)	34 - 46 (Class 3)	
PTS642310	Cotton AD Calf	Open / Closed Toe	✓	✓	✓	XS / S / M / L
PTS642315	Cotton Extra AD Calf	Open / Closed Toe	✓	✓	✓	XS / S / M / L
PTS642320	Cotton Calf with Grip Top	Open / Closed Toe	-	✓	-	XS / S / M / L
PTS642325	Cotton Thigh with Grip Top	Open / Closed Toe	✓	✓	-	XS / S / M / L
PTS642330	Cotton Pantyhose	Open / Closed Toe	-	✓	-	XS / S / M / L
PTS642335	Cotton Chaps	Left or Right	✓	✓	✓	XS / S / M / L

### Sigvaris - Traditional - Unisex

- Reliable safe and effective option
- Colour available: **Beige**
- The elasticity and breathability mean that they are very comfortable to wear



Size Guide				
Size	Ankle (cm)	Below Knee (cm) (Calf)	Mid Thigh (cm) (Thigh)	Upper Thigh (cm) (Pantyhose & Chaps)
XS	17 - 19	26 - 32	39 - 48	40 - 50
S	19 - 23	28 - 34	41 - 50	42 - 52
M	23 - 26	31 - 37	48 - 57	50 - 60
L	26 - 29	34 - 40	55 - 64	58 - 68

**Measurement:** All measurements are circumferences. **Ankle** - Narrowest part (just above ankle bone).  
**Below Knee** - 2cm below knee. **Mid Thigh** - Around mid thigh. **Upper Thigh** - 5cm below groin



DVA: AR22

Code	Description	Style	Compression (mmHg)				Size
			18 - 21 (Class 1)	23 - 32 (Class 2)	34 - 46 (Class 3)	49 (Class 4)	
PTS642340	Traditional Calf	Open / Closed Toe	-	✓	✓	✓	XS / S / M / L
PTS642345	Traditional Half Thigh	Open / Closed Toe	-	✓	✓	✓	XS / S / M / L
PTS642350	Traditional Half Thigh with Grip Top	Open / Closed Toe	-	✓	✓	-	XS / S / M / L
PTS642355	Traditional Thigh	Open / Closed Toe	-	✓	✓	-	XS / S / M / L
PTS642360	Traditional Half Thigh with Grip Top	Open / Closed Toe	-	✓	✓	-	XS / S / M / L
PTS642365	Traditional Chaps Open Toe	Left / Right	-	✓	✓	-	S / M / L
PTS642370	Traditional Pantyhose	-	-	✓	-	-	S / M / L
PTS642375	Traditional Pantyhose For Men	-	-	✓	-	-	S / M / L

#### DVA Contact Details

P 1300 888 052 | F 1300 787 052 | E [dva@aidacare.com.au](mailto:dva@aidacare.com.au)



For NDIS Item Code,  
refer to page: 508





## Sigvaris - Magic - Women

- The elegant look and subtle sheer quality of Sigvaris Magic appeals to the senses
- This versatile compression stocking is exceptionally easy to handle and offers a perfect fit
- Colour available: **Skin**

Size Guide				
Size	Ankle (cm)	Below Knee (cm) (Calf)	Upper Thigh (cm) (Thigh Grip Tops)	Upper Thigh (cm) (Pantyhose & Chaps)
XS	20 - 22	27 - 34	47 - 56	47 - 56
S	22 - 24	31 - 38	52 - 61	52 - 64
M	24 - 26	34 - 41	56 - 65	56 - 68
L	26 - 29	37 - 44	61 - 71	61 - 74

**Measurement:** All measurements are circumferences. **Ankle** - Narrowest part (just above ankle bone). **Below Knee** - 2cm below knee. **Upper Thigh** - 5cm below groin



DVA: AR22

Code	Description	Style	Compression (mmHg)		Size
			18 - 21 (Class 1)	23 - 32 (Class 2)	
PTS642380	Magic Calf	Open / Closed Toe	✓	✓	XS / S / M / L
PTS642385	Magic Thigh with Grip Top	Open / Closed Toe	✓	✓	XS / S / M / L
PTS642390	Magic Panty	-	✓	✓	XS / S / M / L

## Sigvaris - Ulcer X - Unisex

- Ulcer X is a compression stocking that is easy to don, comfortable and discrete
- Offers quicker healing rates compared to conventional bandaging
- Colour available: **Beige**

Size Guide		
Size	Ankle (cm)	Below Knee (cm) (Calf)
S	19 - 23	28 - 34
M	23 - 26	31 - 37
L	26 - 29	34 - 40

**Measurement:** All measurements are circumferences. **Ankle** - Narrowest part (just above ankle bone). **Below Knee** - 2cm below knee.



DVA: AR22

Code	Description	Style	Compression (mmHg)	Size
			23 - 32 (Class 2)	
PTS642395	Ulcer X Kit - Calf (1 stocking; 2 underliners)	Open Toe	✓	S / M / L
PTS642400	Ulcer X Underliners	-	-	One Size

### General Enquiries

P 1300 133 120 | E sales@aidacare.com.au | W www.aidacare.com.au



## Sigvaris - Post Surgery - Unisex

- This stocking is suitable for patients who have undergone leg surgery
- Available in traditional quality for maximum pressure stability throughout the day
- Colour available: **Beige**



Size Guide				
Size	Ankle (cm)	Below Knee (cm) (Calf)	Mid Thigh (cm) (Thigh)	Upper Thigh (cm) (Pantyhose & Chaps)
S	19 - 23	28 - 34	41 - 50	42 - 52
M	23 - 26	31 - 37	48 - 57	50 - 60
L	26 - 29	34 - 40	55 - 64	58 - 68

**Measurement:** All measurements are circumferences. **Ankle** - Narrowest part (just above ankle bone). **Below Knee** - 2cm below knee **Mid Thigh** - Around mid thigh. **Upper Thigh** - 5cm below groin



DVA: AR22

Code	Description	Style	Compression (mmHg)		Size
			23 - 32 (Class 2)	34 - 46 (Class 3)	
PTS642405	Post Surgery Kit (1 stocking; 2 underliners)	Open Toe	✓	✓	S / M / L
PTS642410	Post Surgery Underliners	-	-	-	One Size

## Solaris

**SOLARIS**  
FREEDOM TO LIVE

### Overview

- The Solaris brand offers a wide range of compression garments to suit users with different needs
- The range includes ReadyWrap, ExoStrong, ExoFusion, Caresia

### To Order

Choose your preferred model, then use the Size Guide to select the appropriate size and code

## ReadyWrap (Inelastic Compression)

- ReadyWrap garments are designed to aid people living with venous disease or insufficiencies
- Created to replace daytime compression bandaging or serve as an alternative or supplement to elastic compression stockings
- Silver microfibre under-garment liner is available for added comfort
- Contraindications: arterial insufficiency or degeneration, deep vein thrombosis, untreated congestive heart failure, localised or systemic infection or cancer, absent or severely impaired sensation

## Solaris - ReadyWrap - Toe

- Unique design allows for adjustable toe girths
- Provides full foot coverage when paired with a ReadyWrap foot unit



DVA: AR22

Size Guide			Left	Right
Size	MTP Girth (cm)	Colour	Code	
Medium	20.5 - 23.5	Beige	PTS642645	PTS642648
Large	23.6 - 26	Beige	PTS642644	PTS642647
X Large	26.1 - 28.5	Beige	PTS642646	PTS642649





## Solaris - ReadyWrap - Foot

- The simple two-strap design of the ReadyWrap foot unit fits into most shoes and allows for easier donning
- It is the perfect alternative for those having difficulty donning elastic stockings or whose skin may be compromised by shear forces
- Left and right specific design provides enhanced foot contouring



DVA: AR22

Size Guide				Left	Right	
Size	Foot Length (cm)	Y Girth (cm)	Ankle Girth (cm)	Code		
Small	up to 21	28 - 33	18 - 23	Beige	FBS303597	FBS303605
				Black	FBS303598	FBS303606
Medium	up to 23	30 - 38	20 - 28	Beige	FBS303595	FBS303603
				Black	FBS303596	FBS303604
Large	up to 26	35 - 43	25 - 33	Beige	FBS303593	FBS303601
				Black	FBS303594	FBS303602
X Large	up to 29	40 - 48	30 - 38	Beige	FBS303599	FBS303607
				Black	FBS303600	FBS303608

## Solaris - ReadyWrap - Calf

- Maximum therapeutic benefits, excellent contouring and complete comfort
- The strapping system mimics the 50% overlap of short-stretch bandaging and reduces shear force pressure when being applied to the limb
- Velcro strap placement is designed to minimise strap shifting and enhance ease of donning
- Low-stretch materials provide simultaneous low resting/high working pressure, maximising calf muscle function, especially when exercising or walking
- Can be worn alone or on top of compression hosiery



DVA: AR22

Size Guide			Average (length up to 30cm)	Tall (length up to 35cm)	
Size	Ankle Girth (cm)	Calf Girth (cm)	Code		
Small	18 - 23	28 - 38	Beige	FBS303617	FBS303619
			Black	FBS303618	FBS303620
Medium	20 - 28	33 - 43	Beige	FBS303613	FBS303615
			Black	FBS303614	FBS303616
Large	25 - 33	38 - 48	Beige	FBS303609	FBS303611
			Black	FBS303610	FBS303612
X Large	30 - 38	43 - 58	Beige	FBS303621	FBS303623
			Black	FBS303622	FBS303624
XX Large	35 - 43	53 - 68	Beige	FBS303625	FBS303627
			Black	FBS303626	FBS303628



## Solaris - ReadyWrap - Knee

- The ReadyWrap knee unit provides support for those with localised patella swelling or acts as a bridge connecting the thigh and calf units to provide full leg coverage
- The simple 3-strap design makes that unit easy to don and the 50% overlap mimics short-stretch bandaging

✓ DVA: AR22

Size Guide				Code
Size	Calf Girth (cm)	Above Knee Girth (cm)	Colour	
Small	28 - 38	38 - 48	Beige	FBS303633
			Black	FBS303634
Medium	33 - 43	45 - 58	Beige	FBS303631
			Black	FBS303632
Large	38 - 48	52 - 68	Beige	FBS303629
			Black	FBS303630
X Large	43 - 58	59 - 78	Beige	FBS303635
			Black	FBS303636
XX Large	53 - 68	66 - 88	Beige	FBS303637
			Black	FBS303638



## Solaris - ReadyWrap - Thigh

- The perfect addition to the ReadyWrap knee, calf and foot units for those with full leg oedema
- When used on its own, it is also a great option to prevent localised swelling from the superior patella border to the groin
- The strapping system mimics the 50% overlap of short-stretch bandaging and reduces shear force pressure when being applied to the limb

✓ DVA: AR22

Size Guide				Average (length up to 25cm)	Tall (length up to 30cm)
Size	Above Knee Girth (cm)	Groin Girth (cm)	Colour	Code	
Small	38 - 48	48 - 63	Beige	FBS303647	FBS303649
			Black	FBS303648	FBS303650
Medium	45 - 58	58 - 73	Beige	FBS303643	FBS303645
			Black	FBS303644	FBS303646
Large	52 - 68	68 - 83	Beige	FBS303639	FBS303641
			Black	FBS303640	FBS303642
X Large	59 - 78	78 - 93	Beige	FBS303651	FBS303653
			Black	FBS303652	FBS303654
XX Large	66 - 88	88 - 103	Beige	FBS303655	FBS303657
			Black	FBS303656	FBS303658



## Solaris - Extender Strap

- Provides an additional 10cm to a standard ReadyWrap strap
- The unique forked design ensures a secure fit
- Available in **black or beige**

✓ DVA: AR22

Description	Code
Extender Strap - Beige	FBS303591
Extender Strap - Black	FBS303592

## Solaris - Silver Liner

- These non-compressive Solaris Silver Liners are specifically designed to be used under the Solaris ReadyWrap for additional comfort
- Manufactured with unique silver, antimicrobial properties for maximum comfort and protection
- Ordered per pair - fits left or right
- Colour available: **Black**

✓ DVA: AR22

Description	Girth Range (cm)	Calf Girth (cm)	Code
Below Knee	Up to 68	28 - 38	PTS642641
Thigh High - Universal	48 - 74	33 - 43	PTS642643
Thigh High - Large	74 - 103	38 - 48	PTS642642





## Solaris - ExoStrong

- ExoStrong garments are designed to move with you
- With a functional design at the ankle and knee, you can enjoy the freedom to move
- ExoStrong garments use flat seams. This helps reduce skin irritation and keeps you comfortable
- ExoStrong provides 20 - 30mmHg of compression
- An open toe design
- Available in **beige**



### Solaris - ExoStrong - Knee (20 - 30mmHg)



DVA: AR22

Size Guide				Short Foot Length: up to 17cm Calf Length: up to 38cm	Average Foot Length: up to 19cm Calf Length: up to 41cm	Tall Foot Length: up to 22cm Calf Length: up to 44cm
Size	Ankle Girth (cm)	Calf Girth (cm)	Style	Code		
Small	18 - 20	27 - 36	Knit Top	-	PTS642595	PTS642605
			Silicone Top	PTS642587	PTS642596	PTS642606
Medium	20 - 24	29 - 29	Knit Top	PTS642588	PTS642597	PTS642607
			Silicone Top	-	PTS642598	PTS642608
Large	24 - 28	32 - 43	Knit Top	PTS642589	PTS642599	PTS642609
			Silicone Top	PTS642590	PTS642600	PTS642610
X Large	28 - 31	33 - 45	Knit Top	PTS642591	PTS642601	PTS642611
			Silicone Top	PTS642592	PTS642602	PTS642612
XX Large	32 - 34	37 - 50	Knit Top	PTS642593	PTS642603	PTS642613
			Silicone Top	PTS642594	PTS642604	PTS642614

### Solaris - ExoStrong - Thigh (20 - 30mmHg)

Size Guide				Short Foot Length: up to 17cm Thigh Length: up to 71cm	Average Foot Length: up to 19cm Thigh Length: up to 74cm	Tall Foot Length: up to 22cm Thigh Length: up to 77cm
Size	Ankle Girth (cm)	Calf Girth (cm)	Thigh Girth (cm)	Code		
Small	18 - 20	27 - 36	41 - 55	PTS642615S	PTS642616S	PTS642617S
Medium	20 - 24	29 - 29	45 - 61	PTS642615M	PTS642616M	PTS642617M
Large	24 - 28	32 - 43	50 - 66	PTS642615L	PTS642616L	PTS642617L
X Large	28 - 31	33 - 45	56 - 71	PTS642615XL	PTS642616XL	PTS642617XL

### Solaris - ExoFusion - Knee (20 - 30mmHg)

- Focused compression over the foot makes ExoFusion easier to put on than a regular compression stocking
- ExoFusion is made with material that helps regulate temperature and moisture
- ExoFusion provides a focused 20 - 30mmHg compression over the foot
- Available in **black**



DVA: AR22

Size Guide		Short (Foot Length: up to 21cm)	Tall (Foot Length: up to 28cm)
Size	MTP Girth (cm)	Code	
Medium	20 - 24	PTS642581	PTS642584
Large	24 - 28	PTS642582	PTS642585
X Large	28 - 32	PTS642583	-





## Solaris - Caresia - Lymphoedema Compression Bandage Liners

- Simplify complex multi-layered bandaging protocols by replacing and improving upon foam liners, stockinette and gauze
- The unique foam chips used in every Caresia garment help resolve tissue induration, stimulate interstitial fluid movement, and diffuse irregular wrapping pressures. The foam also helps provide padding protection to limbs

### Foot



DVA: AR22

Size Guide			
Size	Foot Length (cm)	Ankle Girth (cm)	Code
Small	20 - 25	22 - 28	PTS6426560
Medium	25 - 30	28 - 34	PTS6426561
Large	30 - 35	34 - 40	PTS6426562



### Below Knee

Size Guide			Short (Calf Length: 35 - 41cm)	Average (Calf Length: 41 - 47cm)	Tall (Calf Length: 47 - 53cm)
Size	Ankle Girth (cm)	Calf Girth (cm)	Code		
Small	22 - 28	30 - 40	PTS642230	PTS642230AS	PTS642230TS
Medium	28 - 34	40 - 52	PTS642230M	PTS642230AM	PTS642230TM
Large	34 - 40	52 - 62	PTS642230L	PTS642230AL	PTS642230TL

### Thigh



DVA: AR22

Size Guide		Short (Thigh Length: 23 - 28cm)	Average (Thigh Length: 28 - 33cm)	Tall (Thigh Length: 33 - 38cm)
Size	Groin Girth (cm)	Code		
Small	45 - 65	PTS642625	PTS642622	PTS642628
Medium	65 - 85	PTS642624	PTS642621	PTS642627
Large	85 - 99.9	PTS642623	PTS642620	PTS642626



For Pressure Care  
Cushions Refer to  
Page 133



## TED Anti-Embolism Legwear

### Overview

- TED anti-embolism stockings with graduated compression are designed to ensure optimum blood flow velocity when the wearer is immobile in bed for long periods of time
- They are widely used in hospitals for non-ambulatory or convalescing persons to avoid the danger of thromboembolic disease (blood clotting)
- TED stockings are full-foot, but feature an inspection opening under the toes
- Unisex and available in **white**



### To Order

Choose your preferred model, then use the Size Guide to select the appropriate size and code

### TED - Knee High

- TED knee high stockings are designed to reduce venous stasis below the knee when thigh length styles are medically contraindicated
- Knee length with soft top band to minimise slippage without constricting circulation
- Available in 6 sizes, with choice of either regular or long fit



DVA: AR22

Size Guide				Product Code (Regular)	Product Code (Long)
Size	Calf (cm)	Leg Length (cm) (Regular)	Leg Length (cm) (Long)		
Small	to 30.5	to 40.6	40.6+	PTS641570	PTS641600
Medium	30.5 - 38.1	to 43.2	43.2+	PTS641580	PTS641610
Large	38.1 - 44.5	to 45.7	45.7+	PTS641590	PTS641620
X Large	44.5 - 50.8	to 45.7	45.7+	PTS641591	PTS641621
XX Large	50.8 - 58.4	to 45.7	45.7+	PTS641592	PTS641622
XXX Large	58.4 - 66.0	to 45.7	45.7+	PTS641593	PTS641623

**Measurement:** All measurements are circumferences. **Calf** - Widest part. **Leg Length** - From heel to bend in back of knee.

Note: if one measurement indicates a larger size than the other, select the larger size.

### TED - Thigh High - Grip Top

- Pressure break at knee, protecting the critical popliteal area and promoting free leg movement in the recumbent patient
- Available in 5 sizes, with choice of either, short, regular or long fit



DVA: AR22

Size Guide						Code (Short)	Code (Regular)	Code (Long)
Size	Calf (cm)	Thigh (cm)	Leg Length (cm)					
			Short	Regular	Long			
Small	to 30.5	to 63.5	to 73.7	73.7 - 83.8	83.8+	PTS641471	PTS641476	PTS641482
Medium	30.5 - 38.1	to 63.5	to 73.7	73.7 - 83.8	83.8+	PTS641475	PTS641477	PTS641483
Large	38.1 - 44.5	to 63.5	to 73.7	73.7 - 83.8	83.8+	PTS641472	PTS641478	PTS641484
X Large	44.5 - 54.6	63.5 - 81.3	to 73.7	73.7 - 83.8	83.8+	PTS641473	PTS641479	PTS641485
XX Large	54.6 - 66.0	81.3 - 91.4	to 73.7	73.7 - 83.8	83.8+	PTS641474	PTS641481	PTS641486

**Measurement:** All measurements are circumferences. **Calf** - Widest part. **Thigh** - 5cm below groin. **Leg Length** - From heel to gluteal furrow (just below groin)

Note: In thigh length stockings, when applied, the stitch change (change in fabric sheerness) should fall between 2.5 to 5cm below the bend in the knee. If thigh exceeds 91.4cm, select knee length style

### General Enquiries

P 1300 133 120 | E sales@aidacare.com.au | W www.aidacare.com.au



## TED - Thigh High - Waist Belt

- The TED thigh high with waist belt is very suitable for thin or obese patients, where stocking slippage is often a problem
- One-piece, snap-on belt is easily adjustable
- Pressure break at knee, protecting the critical popliteal area and promoting free leg movement in the recumbent patient
- Available in 5 sizes, with choice of either regular or long fit
- Supplied per pair



DVA: AR22

Size Guide					Code (Regular)	Code (Long)
Size	Calf (cm)	Thigh (cm)	Leg Length (cm) (Regular)	Leg Length (cm) (Long)		
X Small	to 25.4	to 63.5	to 71.1	71.1+	PTS641425	PTS641501
Small	25.4 - 30.5	to 63.5	to 72.4	72.4+	PTS641430	PTS641502
Medium	30.5 - 38.1	to 63.5	to 72.4	72.4+	PTS641460	PTS641503
Large	38.1 - 44.5	to 63.5	to 73.7	73.7+	PTS641470	PTS641504
X Large	38.1 - 44.5	63.5 - 81.3	to 72.4	72.4+	PTS641500	PTS641505

**Measurement:** All measurements are circumferences. **Calf** - Widest part. **Thigh** - 5cm below groin. **Leg Length** - From heel to gluteal furrow (just below groin)  
Note: In high length stockings, when applied, the stitch change (change in fabric sheerness) should fall between 2.5 to 5cm below the bend in the knee.

## TED - Continuing Care

- Designed for the continuing care of the recuperating patient after leaving hospital
- To be worn only on physician's advice and during the time period recommended
- Unisex, knee length, closed toe without inspection opening
- Available in 4 sizes, with choice of either regular or long fit
- Supplied per pair
- Colour: **White**



DVA: AR22

Size Guide				Code (Regular)	Code (Long)
Size	Calf (cm)	Leg Length (cm) (Regular)	Leg Length (cm) (Long)		
Small	to 30.5	to 40.6	40.6+	PTS641630	PTS641634
Medium	30.5 - 38.1	to 43.2	43.2+	PTS641631	PTS641635
Large	38.1 - 44.5	to 45.7	45.7+	PTS641632	PTS641636
X Large	44.5 - 50.8	to 45.7	45.7+	PTS641633	PTS641637

**Measurement:** All measurements are circumferences. **Calf** - Widest part. **Leg Length** - From heel to bend in back of knee.

## Venosan - Medical Legwear

### Overview

- Venosan compression garments have been manufactured since 1942 and are distributed in over 70 countries



### To Order

Choose your preferred model, then use the Size Guide to select the appropriate size and code

### Size Guide

- Take circumferential measurements to determine size (thigh measurement only needed for thigh & waist high stockings)

Size Guide				
Circumference	Small	Medium	Large	X Large
Ankle (cm)	19 - 23	23 - 26	26 - 29	29 - 31
Calf (cm)	29 - 39	33 - 42	36 - 45	39 - 47
Below Knee (cm)	28 - 38	32 - 41	35 - 44	38 - 46
Thigh (cm)	48 - 63	54 - 67	58 - 72	63 - 74

**Measurement:** All measurements are circumferences. **Ankle** - Narrowest part (just above ankle bone). **Calf** - Widest part. **Below Knee** - 2cm below knee.  
**Upper Thigh** - 5cm below groin

### DVA Contact Details

P 1300 888 052 | F 1300 787 052 | E [dva@aidacare.com.au](mailto:dva@aidacare.com.au)



For NDIS Item Code, refer to page: 508





## Venosan 'Perflor' Medical Legwear

- VENOSAN® Perflor is a soft, strong and robust garment with a high cotton content
- Suitable for: lymphoedema, severe swelling, lipoeidema & ulcer-care
- Available in **beige and open toe only**. Unisex sizes
- Compression: 23-32mmHg



DVA: AR22

Size Guide				Code
Size	Ankle (cm)	Calf (cm)	Below Knee (cm)	
Small	20 - 22	31 - 36	29 - 34	PTS641999
Medium	22 - 24	34 - 39	32 - 37	PTS641999M
Large	24 - 26	37 - 42	35 - 40	PTS641999L
X Large	26 - 28	40 - 45	38 - 43	PTS641999XL

**Measurement:** All measurements are circumferences. **Ankle** - Narrowest part (just above ankle bone). **Calf** - Widest part. **Below Knee** - 2cm below knee

## Venosan 4000 Series - Nylon - Unisex

- Venosan 4000 is manufactured in a refined sandwich construction and is the first compression stocking in the world to be awarded the TACTEL climate effect label
- Suitable for: varicose veins, ulceration, thrombosis, sclerotherapy, pregnancy, work & travel
- The Venosan 4000 Series is available in: knee high, thigh high, chaps, pantyhose styles



## Venosan 4000 Series - Knee High



DVA: AR22

Size	Colour	18 - 22mmHg		23 - 32mmHg	
		Open Toe	Closed Toe	Open Toe	Closed Toe
Small	Black	PTS641956OBLS	PTS641956CBLS	PTS641957OBLS	PTS641957CBLS
	Marokko	PTS641956	PTS641956CMAS	PTS641957	PTS641957CMAS
Medium	Black	PTS641956OBLM	PTS641956CBLM	PTS641957OBLM	PTS641957CBLM
	Marokko	PTS641956OMAM	PTS641956CMAM	PTS641957OMAM	PTS641957CMAM
Large	Black	PTS641956OBLL	PTS641956CBLL	PTS641957OBLL	PTS641957CBLL
	Marokko	PTS641956OMAL	PTS641956CMAL	PTS641957OMAL	PTS641957CMAL
X Large	Black	PTS641956OBXL	PTS641956CBXL	PTS641957OBXL	PTS641957CBXL
	Marokko	PTS641956OMAXL	PTS641956CMAXL	PTS641957OMAXL	PTS641957CMAXL

## Venosan 4000 Series - Thigh High - Grip Top



DVA: AR22

Size	Colour	18 - 22mmHg		23 - 32mmHg	
		Open Toe	Closed Toe	Open Toe	Closed Toe
Small	Black	PTS641959OBLS	PTS641959PTBLS	PTS641960OBLS	PTS641960PTBLS
	Marokko	PTS641959	PTS641959PTMAS	PTS641960	PTS641960PTMAS
Medium	Black	PTS641959OBLM	PTS641959PTBLM	PTS641960OBLM	PTS641960PTBLM
	Marokko	PTS641959OMAM	PTS641959PTMAM	PTS641960OMAM	PTS641960PTMAM
Large	Black	PTS641959OBLL	PTS641959PTBLL	PTS641960OBLL	PTS641960PTBLL
	Marokko	PTS641959OMAL	PTS641959PTMAL	PTS641960OMAL	PTS641960PTMAL
X Large	Black	PTS641959OBXL	PTS641959PTBLXL	PTS641960OBXL	PTS641960PTBLXL
	Marokko	PTS641959OMAXL	PTS641959PTMAXL	PTS641960OMAXL	PTS641960PTMAXL

## Venosan 4000 Series - Chaps - Open Toe



DVA: AR22

Size	Colour	23 - 32mmHg	
		Code (Left)	Code (Right)
Small	Mexico	PTS641958LS	PTS641958
Medium	Mexico	PTS641958LM	PTS641958RM
Large	Mexico	PTS641958LL	PTS641958RL
X Large	Mexico	PTS641958LXL	PTS641958RXL

## Venosan 4000 Series - Pantyhose - Closed Toe



DVA: AR22

Size	Colour	18 - 22mmHg	23 - 32mmHg
		Code	Code
Small	Black	PTS641963BLS	PTS641964BLS
	Marokko	PTS641963	PTS641964
Medium	Black	PTS641963BLM	PTS641964BLM
	Marokko	PTS641963MAM	PTS641964MAM
Large	Black	PTS641963BLL	PTS641964BLL
	Marokko	PTS641963MAL	PTS641964MAL
X Large	Black	PTS641963BLXL	PTS641964BLXL
	Marokko	PTS641963MAXL	PTS641964MAXL

### General Enquiries

P 1300 133 120 | E sales@aidacare.com.au | W www.aidacare.com.au



## Venosan 5000 Series - Cotton - Unisex

- The combination of the thermal properties of X-static, cotton and TACTEL provide the wearer with optimal comfort
- These compression garments are suitable for active men and women
- Styles available: knee high or chaps, in a choice of **two colours**



### Venosan 5000 Series - Knee High



DVA: AR22

Size	Colour	18 - 22mmHg		23 - 32mmHg		36 - 48mmHg	
		Open Toe	Closed Toe	Open Toe	Closed Toe	Open Toe	Closed Toe
Small	Black	PTS641965OBLS	PTS641965BLS	PTS641966OBLS	PTS641966BLS	PTS641967OBLS	PTS641967BLS
	Marokko	PTS641965	PTS641965MAS	PTS641966	PTS641966MAS	PTS641967	PTS641967MAS
Medium	Black	PTS641965OBLM	PTS641965BLM	PTS641966OBLM	PTS641966BLM	PTS641967OBLM	PTS641967BLM
	Marokko	PTS641965OMAM	PTS641965MAM	PTS641966OMAM	PTS641966MAM	PTS641967OMAM	PTS641967MAM
Large	Black	PTS641965OBLL	PTS641965BLL	PTS641966OBLL	PTS641966BLL	PTS641967OBLL	PTS641967BLL
	Marokko	PTS641965OMAL	PTS641965MAL	PTS641966OMAL	PTS641966MAL	PTS641967OMAL	PTS641967MAL
X Large	Black	PTS641965OBXL	PTS641965BLXL	PTS641966OBXL	PTS641966BLXL	PTS641967OBXL	PTS641967BLXL
	Marokko	PTS641965OMAXL	PTS641965MAXL	PTS641966OMAXL	PTS641966MAXL	PTS641967OMAXL	PTS641967MAXL

### Venosan 5000 Series - Chaps - Open Toe



DVA: AR22

Size	Colour	18 - 22mmHg	
		Code (Left)	Code (Right)
Small	Black	PTS641970LBLS	PTS641970RBLS
	Marokko	PTS641970LMAS	PTS641970
Medium	Black	PTS641970LBLM	PTS641970RBLM
	Marokko	PTS641970LMAM	PTS641970RMAM
Large	Black	PTS641970LBLL	PTS641970RBLL
	Marokko	PTS641970LMAL	PTS641970RMAL
X Large	Black	PTS641970LBXL	PTS641970RBLXL
	Marokko	PTS641970LMAXL	PTS641970RMAXL

## Venosan 6000 Series - Nylon / Lycra - Unisex

- Fulfills the strict requirements of RAL certification
- Cost effective without compromise, optimal fit, easy care
- The Venosan 6000 Series is available in: knee high, thigh high, pantyhose styles
- Available in **black or beige**, with a choice of three compression ratings



### Venosan 6000 Series - Knee High



DVA: AR22

Size	Colour	18 - 22mmHg		23 - 32mmHg		36 - 48mmHg
		Open Toe	Closed Toe	Open Toe	Closed Toe	Open Toe
<b>Short (34 - 39cm)</b>						
Small	Black	PTS641974	PTS641974CSBLS	PTS641975	PTS641975CSBLS	-
	Beige	PTS641974OSBES	PTS641974CSBES	PTS641975OSBES	PTS641975CSBES	PTS641976OSBES
Medium	Black	PTS641974OSBLM	PTS641974CSBLM	PTS641975OSBLM	PTS641975CSBLM	-
	Beige	PTS641974OSBEM	PTS641974CSBEM	PTS641975OSBEM	PTS641975CSBEM	PTS641976OSBEM
Large	Black	PTS641974OSBLL	PTS641974CSBLL	PTS641975OSBLL	PTS641975CSBLL	-
	Beige	PTS641974OSBEL	PTS641974CSBEL	PTS641975OSBEL	PTS641975CSBEL	PTS641976OSBEL
X Large	Black	PTS641974OSBLXL	PTS641974CSBLXL	PTS641975OSBLXL	PTS641975CSBLXL	-
	Beige	PTS641974OSBEXL	PTS641974CSBEXL	PTS641975OSBEXL	PTS641975CSBEXL	PTS641976OSBEXL
<b>Long (39 - 44cm)</b>						
Small	Black	PTS641974OLBLS	PTS641974CLBLS	PTS641975OLBLS	PTS641975CLBLS	-
	Beige	PTS641974OLBES	PTS641974CLBES	PTS641975OLBES	PTS641975CLBES	PTS641976OLBES
Medium	Black	PTS641974OLBLM	PTS641974CLBLM	PTS641975OLBLM	PTS641975CLBLM	-
	Beige	PTS641974OLBEM	PTS641974CLBEM	PTS641975OLBEM	PTS641975CLBEM	PTS641976OLBEM
Large	Black	PTS641974OLBLL	PTS641974CLBLL	PTS641975OLBLL	PTS641975CLBLL	-
	Beige	PTS641974OLBEL	PTS641974CLBEL	PTS641975OLBEL	PTS641975CLBEL	PTS641976OLBEL
X Large	Black	PTS641974OLBLXL	PTS641974CLBLXL	PTS641975OLBLXL	PTS641975CLBLXL	-
	Beige	PTS641974OLBEXL	PTS641974CLBEXL	PTS641975OLBEXL	PTS641975CLBEXL	PTS641976OLBEXL

**Measurement:** To determine Short or Long, measure from the floor to 2cm below the knee

#### DVA Contact Details

P 1300 888 052 | F 1300 787 052 | E [dva@aidocare.com.au](mailto:dva@aidocare.com.au)



For NDIS Item Code, refer to page: 508





## Venosan 6000 Series - Thigh High - Grip Top



DVA: AR22

Size	Colour	18 - 22mmHg		23 - 32mmHg		36 - 48mmHg
		Open Toe	Closed Toe	Open Toe	Closed Toe	Open Toe
<b>Short (59 - 67cm)</b>						
Small	Black	PTS641977	PTS641977CSBLS	PTS641978	PTS641978CSBLS	-
	Beige	PTS641977OSBES	PTS641977CSBES	PTS641978OSBES	PTS641978CSBES	PTS641979OSBES
Medium	Black	PTS641977OSBLM	PTS641977CSBLM	PTS641978OSBLM	PTS641978CSBLM	-
	Beige	PTS641977OSBEM	PTS641977CSBEM	PTS641978OSBEM	PTS641978CSBEM	PTS641979OSBEM
Large	Black	PTS641977OSBLL	PTS641977CSBLL	PTS641978OSBLL	PTS641978CSBLL	-
	Beige	PTS641977OSBEL	PTS641977CSBEL	PTS641978OSBEL	PTS641978CSBEL	PTS641979OSBEL
X Large	Black	PTS641977OSBLXL	PTS641977CSBLXL	PTS641978OSBLXL	PTS641978CSBLXL	-
	Beige	PTS641977OSBEXL	PTS641977CSBEXL	PTS641978OSBEXL	PTS641978CSBEXL	PTS641979OSBEXL
<b>Long (68 - 78cm)</b>						
Small	Black	PTS641977OLBLS	PTS641977CLBLS	PTS641978OLBLS	PTS641978CLBLS	-
	Beige	PTS641977OLBES	PTS641977CLBES	PTS641978OLBES	PTS641978CLBES	PTS641979
Medium	Black	PTS641977OLBLM	PTS641977CLBLM	PTS641978OLBLM	PTS641978CLBLM	-
	Beige	PTS641977OLBEM	PTS641977CLBEM	PTS641978OLBEM	PTS641978CLBEM	PTS641979OLBEM
Large	Black	PTS641977OLBLL	PTS641977CLBLL	PTS641978OLBLL	PTS641978CLBLL	-
	Beige	PTS641977OLBEL	PTS641977CLBEL	PTS641978OLBEL	PTS641978CLBEL	PTS641979OLBEL
X Large	Black	PTS641977OLBLXL	PTS641977CLBLXL	PTS641978OLBLXL	PTS641978CLBLXL	-
	Beige	PTS641977OLBEXL	PTS641977CLBEXL	PTS641978OLBEXL	PTS641978CLBEXL	PTS641979OLBEXL

**Measurement:** To determine Short or Long, measure from the floor to 5cm below the groin

## Venosan 6000 Series - Pantyhose



DVA: AR22

<b>CLOSED TOE ONLY</b>						
Size	Colour	18 - 22mmHg	23 - 32mmHg	36 - 48mmHg		
		<b>Short (67 - 74cm)</b>				
Small	Black	PTS641980	PTS641981	-		
	Beige	PTS641980CSBES	PTS641981CSBES	PTS641982CSBES		
Medium	Black	PTS641980CSBLM	PTS641981CSBLM	-		
	Beige	PTS641980CSBEM	PTS641981CSBEM	PTS641982CSBEM		
Large	Black	PTS641980CSBLL	PTS641981CSBLL	-		
	Beige	PTS641980CSBEL	PTS641981CSBEL	PTS641982CSBEL		
X Large	Black	PTS641980CSBLXL	PTS641981CSBLXL	-		
	Beige	PTS641980CSBEXL	PTS641981CSBEXL	PTS641982CSBEXL		
<b>Long (74 - 85cm)</b>						
Small	Black	PTS641980CLBLS	PTS641981CLBLS	-		
	Beige	PTS641980CLBES	PTS641981CLBES	PTS641982		
Medium	Black	PTS641980CLBLM	PTS641981CLBLM	-		
	Beige	PTS641980CLBEM	PTS641981CLBEM	PTS641982CLBEM		
Large	Black	PTS641980CLBLL	PTS641981CLBLL	-		
	Beige	PTS641980CLBEL	PTS641981CLBEL	PTS641982CLBEL		
X Large	Black	PTS641980CLBLXL	PTS641981CLBLXL	-		
	Beige	PTS641980CLBEXL	PTS641981CLBEXL	PTS641982CLBEXL		

**Measurement:** To determine Short or Long, measure from the floor to the groin





## Venosan 7000 Series - Opaque - Unisex

- Compression stockings with high stiffness and increased massage effect. Suitable for: lymphoedema/heavy swelling & ulcerated legs with compromised skin condition
- Antibacterial and fungicidal action inhibits the growth of bacteria and fungi



## Venosan 7000 Series - Knee High



DVA: AR22

Size	Colour	23 - 32mmHg		36 - 48mmHg	
		Open Toe	Closed Toe	Open Toe	Closed Toe
<b>Short (34 - 39cm)</b>					
Small	Black	PTS641983	PTS641983CSBLS	PTS641984	PTS641984CSBLS
	Beige	PTS641983OSBES	PTS641983CSBES	PTS641984OSBES	PTS641984CSBES
Medium	Black	PTS641983OSBLM	PTS641983CSBLM	PTS641984OSBLM	PTS641984CSBLM
	Beige	PTS641983OSBEM	PTS641983CSBEM	PTS641984OSBEM	PTS641984CSBEM
Large	Black	PTS641983OSBLL	PTS641983CSBLL	PTS641984OSBLL	PTS641984CSBLL
	Beige	PTS641983OSBEL	PTS641983CSBEL	PTS641984OSBEL	PTS641984CSBEL
X Large	Black	PTS641983OSBLXL	PTS641983CSBLXL	PTS641984OSBLXL	PTS641984CSBLXL
	Beige	PTS641983OSBEXL	PTS641983CSBEXL	PTS641984OSBEXL	PTS641984CSBEXL
<b>Long (39 - 44cm)</b>					
Small	Black	PTS641983OLBLS	PTS641983CLBLS	PTS641984OLBLS	PTS641984CLBLS
	Beige	PTS641983OLBES	PTS641983CLBES	PTS641984OLBES	PTS641984CLBES
Medium	Black	PTS641983OLBLM	PTS641983CLBLM	PTS641984OLBLM	PTS641984CLBLM
	Beige	PTS641983OLBEM	PTS641983CLBEM	PTS641984OLBEM	PTS641984CLBEM
Large	Black	PTS641983OLBLL	PTS641983CLBLL	PTS641984OLBLL	PTS641984CLBLL
	Beige	PTS641983OLBEL	PTS641983CLBEL	PTS641984OLBEL	PTS641984CLBEL
X Large	Black	PTS641983OLBLXL	PTS641983CLBLXL	PTS641984OLBLXL	PTS641984CLBLXL
	Beige	PTS641983OLBEXL	PTS641983CLBEXL	PTS641984OLBEXL	PTS641984CLBEXL

**Measurement:** To determine Short or Long, measure from the floor to 2cm below the knee

## Venosan 7000 Series - Thigh High - Grip Top



DVA: AR22

Size	Colour	23 - 32mmHg		36 - 48mmHg	
		Open Toe	Closed Toe	Open Toe	Closed Toe
<b>Short (59 - 67cm)</b>					
Small	Black	PTS641986	PTS641986CSBLS	PTS641987	PTS641987CSBLS
	Beige	PTS641986OSBES	PTS641986CSBES	PTS641987OSBES	PTS641987CSBES
Medium	Black	PTS641986OSBLM	PTS641986CSBLM	PTS641987OSBLM	PTS641987CSBLM
	Beige	PTS641986OSBEM	PTS641986CSBEM	PTS641987OSBEM	PTS641987CSBEM
Large	Black	PTS641986OSBLL	PTS641986CSBLL	PTS641987OSBLL	PTS641987CSBLL
	Beige	PTS641986OSBEL	PTS641986CSBEL	PTS641987OSBEL	PTS641987CSBEL
X Large	Black	PTS641986OSBLXL	PTS641986CSBLXL	PTS641987OSBLXL	PTS641987CSBLXL
	Beige	PTS641986OSBEXL	PTS641986CSBEXL	PTS641987OSBEXL	PTS641987CSBEXL
<b>Long (68 - 78cm)</b>					
Small	Black	PTS641986OLBLS	PTS641986CLBLS	PTS641987OLBLS	PTS641987CLBLS
	Beige	PTS641986OLBES	PTS641986CLBES	PTS641987OLBES	PTS641987CLBES
Medium	Black	PTS641986OLBLM	PTS641986CLBLM	PTS641987OLBLM	PTS641987CLBLM
	Beige	PTS641986OLBEM	PTS641986CLBEM	PTS641987OLBEM	PTS641987CLBEM
Large	Black	PTS641986OLBLL	PTS641986CLBLL	PTS641987OLBLL	PTS641987CLBLL
	Beige	PTS641986OLBEL	PTS641986CLBEL	PTS641987OLBEL	PTS641987CLBEL
X Large	Black	PTS641986OLBLXL	PTS641986CLBLXL	PTS641987OLBLXL	PTS641987CLBLXL
	Beige	PTS641986OLBEXL	PTS641986CLBEXL	PTS641987OLBEXL	PTS641987CLBEXL

**Measurement:** To determine Short or Long, measure from the floor to 5cm below the groin

### DVA Contact Details

P 1300 888 052 | F 1300 787 052 | E [dva@aidacare.com.au](mailto:dva@aidacare.com.au)



For NDIS Item Code, refer to page: 508



## Venosan 7000 Series - Chaps - Open Toe



DVA: AR22

		23 - 32mmHg	
Size	Colour	Code (Left)	Code (Right)
<b>Short (67 - 74cm)</b>			
Small	Beige	PTS641985LSBES	PTS641985
Medium	Beige	PTS641985LSBEM	PTS641985RSBEM
Large	Beige	PTS641985LSBEL	PTS641985RSBEL
X Large	Beige	PTS641985LSBEXL	PTS641985RSBEXL
<b>Long (74 - 85cm)</b>			
Small	Beige	PTS641985LLBES	PTS641985RLBES
Medium	Beige	PTS641985LLBEM	PTS641985RLBEM
Large	Beige	PTS641985LLBEL	PTS641985RLBEL
X Large	Beige	PTS641985LLBEXL	PTS641985RLBEXL

**Measurement:** To determine Short or Long, measure from the floor to the groin

## Venosan 'Legline' Series

- **Venosan 'Legline 20' Series:** suitable for everyday wear, work & travel. An effective compression stocking with an extremely fine mesh. **Closed toe only**
- **Venosan 'Legline 30' Series:** suitable for work, travel & post-sclerotherapy. An effective compression stocking with an extremely fine mesh. **Closed toe only**



Size Guide				
Circumference	Small	Medium	Large	X Large
Ankle (cm)	22 - 23	24 - 25	26 - 27	28 - 29
Calf (cm)	34 - 36	37 - 39	40 - 42	43 - 45
Below Knee (cm)	32 - 34	35 - 37	38 - 40	41 - 43
Thigh (cm)	45 - 47	48 - 50	51 - 53	54 - 60

**Measurement:**

All measurements are circumferences. **Ankle** - Narrowest part (just above ankle bone). **Calf** - Widest part. **Below Knee** - 2cm below knee. **Thigh** - 5cm below groin



DVA: AR22

		CLOSED TOE ONLY					
		Venosan 'Legline 20' Series (20mmHg)			Venosan 'Legline 30' Series (30mmHg)		
		Knee high	Thigh high (Plain top)	Pantyhose	Knee high	Thigh high (Plain top)	Pantyhose
Size	Colour	Code					
Small	Black	PTS641988	PTS641990	PTS641992	PTS641989	PTS641991	PTS641993
	Nude	PTS641988NUS	PTS641990NUS	PTS641992NUS	PTS641989NUS	PTS641991NUS	PTS641993NUS
Medium	Black	PTS641988BLM	PTS641990BLM	PTS641992BLM	PTS641989BLM	PTS641991BLM	PTS641993BLM
	Nude	PTS641988NUM	PTS641990NUM	PTS641992NUM	PTS641989NUM	PTS641991NUM	PTS641993NUM
Large	Black	PTS641988BLL	PTS641990BLL	PTS641992BLL	PTS641989BLL	PTS641991BLL	PTS641993BLL
	Nude	PTS641988NUL	PTS641990NUL	PTS641992NUL	PTS641989NUL	PTS641991NUL	PTS641993NUL
X Large	Black	PTS641988BLXL	PTS641990BLXL	PTS641992BLXL	PTS641989BLXL	PTS641991BLXL	PTS641993BLXL
	Nude	PTS641988NUXL	PTS641990NUXL	PTS641992NUXL	PTS641989NUXL	PTS641991NUXL	PTS641993NUXL



## Venosan 'Microfibre' Medical Legwear

- Cotton on the inside with a reinforced heel and toe
- Microfibre softness with a comfortable non-restricting top band
- **Closed toe only**



Size Guide					
Circumference		Small	Medium	Large	X Large
Ankle (cm)	Female	16.5 - 20.5	20.5 - 24.5	24.5 - 28	28 - 32
	Male	19.5 - 21.5	21.5 - 24	24 - 26.5	26.5 - 32
Calf (cm)	Female	26.5 - 37	29 - 39.5	32 - 43	34.5 - 47
	Male	28 - 38	33 - 43.5	35.5 - 46	38.5 - 51.5
Shoe Size	Female	34 - 36	37 - 39	40 - 42	43 - 45
	Male	37 - 39	40 - 43	44 - 47	48 - 51

**Measurement:** All measurements are circumferences. **Ankle** - Narrowest part (just above ankle bone). **Calf** - Widest part. **Shoe Size** - European sizes



DVA: AR22

Size	Colour	Code	
		Female	Male
		15 -20mmHg	18 -22mmHg
		15 -20mmHg	18 -22mmHg
Size	Colour	Code	
Small	Black	PTS641997BLS	PTS641996
	Beige	PTS641997	-
Medium	Black	PTS641997BLM	PTS641996M
	Beige	PTS641997BEM	-
Large	Black	PTS641997BLL	PTS641996L
	Beige	PTS641997BEL	-
X Large	Black	PTS641997BLXL	PTS641996XL
	Beige	PTS641997BEXL	-

## Venosan 'Silverline' Medical Legwear (20 - 30mmHg)

- X-static® Silver yarn helps eliminate bacteria and fungi in the socks associated with foot odour, athlete's foot and fungal nail disease. Anti-microbial effect will not wash or wear out
- Superior moisture wicking for dry, comfortable feet and legs. Cool in summer, warm in winter



DVA: AR22

Size Guide					
Circumference		Small	Medium	Large	X Large
Ankle (cm)	Female	16.5 - 20.5	20.5 - 24.5	24.5 - 28	28 - 32
	Male	19.5 - 21.5	21.5 - 24	24 - 26.5	26.5 - 32
Calf (cm)	Female	26.5 - 37	29 - 39.5	32 - 43	34.5 - 47
	Male	28 - 38	33 - 43.5	35.5 - 46	38.5 - 51.5
Shoe Size	Female	34 - 36	37 - 39	40 - 42	43 - 45
	Male	37 - 39	40 - 43	44 - 47	48 - 51

**Measurement:** All measurements are circumferences. **Ankle** - Narrowest part (just above ankle bone). **Calf** - Widest part. **Shoe Size** - European sizes



DVA: AR22

CLOSED TOE ONLY			
Size	Colour	Code	
		Female	Male
Small	Black	PTS641995BLS	PTS641994
	Beige	PTS641995	-
Medium	Black	PTS641995BLM	PTS641994M
	Beige	PTS641995BEM	-
Large	Black	PTS641995BLL	PTS641994L
	Beige	PTS641995BEL	-
X Large	Black	PTS641995BLXL	PTS641994XL
	Beige	PTS641995BEXL	-



### DVA Contact Details

P 1300 888 052 | F 1300 787 052 | E [dva@aidacare.com.au](mailto:dva@aidacare.com.au)



For NDIS Item Code,  
refer to page: 508



## Stocking Accessories

### Easy 'Sim - Slide' On / Off Aid (Open Toe)



- The ultimate donning and doffing aid for open toe compression stockings and tights
- Reduces the physical strain for both the caregiver and user
- Available in 4 sizes



DVA: AU13

Size	Shoe Size	Code
Small	34 - 37	PTS642508
Medium	38 - 41	PTS642509
Large	42 - 45	PTS642510
X Large	46	PTS642511

Shoe Size - European sizes

### Easy Slide 'Magnide' On / Off Aid (Closed Toe)



- The easiest donning and doffing aid for closed toe compression stockings and tights
- Reduces the physical strain for both the caregiver and user



DVA: AU13

Size	Shoe Size	Code
Medium / Large	40 - 45	PTS642514

Shoe Size - European sizes

### Easy Slide 'Magnide' Applicator (Closed Toe)



- The ultimate donning aid for closed toe compression stockings and tights
- Reduces the physical strain for both the caregiver and user



DVA: AU13

Size	Shoe Size	Code
Small / Medium	40	PTS642512
Large / X Large	41	PTS642513

Shoe Size - European sizes

### Medi-Butler Stocking Donner



- The Medi-Butler is used for applying compression knee highs and thigh highs



DVA: AU13

Code	Size
PTS642542	Regular

### Medi-Butler Off - Doffing Aid



- This long handled device assists with the removal of compression stockings, socks and normal pantyhose
- It can also double as a shoehorn



DVA: AU13

Code	Size
PTS642543	Universal

### JOBST Stocking Donner



- Application aid for closed-toe garments
- Slide stockings over, then remove from top of stocking
- Suggest to use with rubber gloves

Code	Size	Shoe Size	DVA:
PTS641090	Small / Med	Up to 38	AU13

Note: Shoe size - European sizes

### Sigvaris Doff N' Donner



- Soft device that allows you to quickly guide a compression garment up and down your limb
- The Cone acts as a loading device to make using the Sigvaris Doff N' Donner even easier
- Sold separately or as a set



DVA: AU13

Code	Description
PTS642660	Doff N' Donner Device
PTS642661	Doff N' Donner Cone (Black)
PTS642662	Doff N' Donner Device & Cone

### Jobst Donning Gloves



- Jobst gloves help create friction, provide grip and help to evenly distribute the fabric on the leg
- This product contains natural rubber Latex



DVA: AU13

Code	Description
FBS303490	Jobst Donning Gloves - Small
FBS303491	Jobst Donning Gloves - Medium



## Stocking Accessories

### Jobst Body Adhesive



- Roll-on body adhesive helps Jobst garments stay in place
- Easy application
- Washes off easily with water without leaving a stain



DVA: AR26

Code	Size
PTS641100	59ml

### Compression Assist Limb Lubricant



- Hypoallergenic skin lubricant makes donning your compression garments an easier process
- Spray bottle for easy application



DVA: AR26

Code	Size
GMS336050	60ml

### Compression Stocking Aid



- Applies support hosiery quickly and evenly
- Grooves catch the compression stocking and prevent it from popping off
- Works like a traditional sock aid - pull the stocking over the shell, insert the foot and pull the cord to bring the hose up onto the leg
- Suitable for Class 1 and 2 stockings

Code	Description	Warranty	DVA:
DLD269110	Compression Stocking Aid - Small	1 Year	AU13
DLD269120	Compression Stocking Aid - Large	1 Year	AU13

### Compression Stocking Aid



- EUREKA-ON Plastic Fabric Slide is a compression stocking applicator for the leg or arm
- Consists of a triangular shaped durable paper-like slippery material with a central extended pull tab and eyelet holes on the sides for threading a thin tubular plastic lacing pin

Code	Description	Warranty	DVA:
DLD269010	Compression Stocking Aid - Eureka	1 Year	AU13



### EzyAs Compression Stocking Applicator

- Unique plastic gutter to assist in pulling on compression stockings
- Stocking is fed onto gutter, held in place by side notches, slipped over foot, then pulled into place

Code	Description	Width	Length	Calf/Arm Circ.	Warranty	DVA:
DLD269001	Small - Red	140 mm	140 mm	280 - 350 mm	1 Year	AU13
DLD269002	Med - Yellow	140 mm	140 mm	320 - 400 mm	1 Year	AU13
DLD269003	Large - Blue	140 mm	175 mm	380 - 470 mm	1 Year	AU13
DLD269004	Handle	210 mm	270 mm	-	1 Year	AU13



For Pressure Care  
Cushions Refer to  
Page 133



# Compression - Armwear



For NDIS Item Code, refer to page: 508



## Compression Armsleeve Overview

### What is Lymphoedema?

- If the lymphatic system is damaged or blocked, excess fluid, which would normally be drained away by the lymphatics, can build up in the tissues (most commonly the arms or legs)
- Lymphoedema in the upper limb is frequently a consequence of surgery or radiotherapy relating to breast cancer, resulting in fluid build-up in the arm, and often the hand

### Importance of compression in the treatment of Lymphoedema

Compression is an important adjunct to ongoing professional treatment of the affected limb. Compression plays a major role in the treatment of lymphoedema by encouraging lymph flow.

Your lymphoedema therapist will advise you on the style and compression appropriate for your particular needs.

INDICATORS	
20-30 mmHG (class 1)	30-40 mmHg (class 2)
<ul style="list-style-type: none"> <li>• Treatment of primary and secondary lymphoedema in stages 1 and 2 of the arm with permanent or partial oedema of the hand</li> <li>• Post-operative (eg. mastectomy) and post-traumatic oedema</li> <li>• Blood poisoning and burn therapy</li> </ul>	

### Styles Available

- The diagrams below depict the most commonly used styles of arm sleeves and hand pieces
- Not all of these styles are available in every brand - the type of top selected (plain or grip) is a personal preference

Arm-Wrist To Axilla			
Plain Top	Grip Top	Bra Attachment	Chest Strap



## Styles Available (contd)

Arm/Hand Combination		Handpiece		
Plain Top	Grip Top	Gauntlet Style (to knuckles)	Short Finger (open tips)	Long Fingers (open tips)

## Fitting & Selection Tips

- Never allow the top of the sleeve to roll or double-over. If there seems to be excess material, ease it gently down the arm until the top is flat against the skin, and ensure no creases or wrinkles remain
- Ensure correct measurements are taken, and that the garment is not too tight or loose
- Advise the therapist of any pain, swelling or colour change of the hand or fingers, or numbness in any part of the limb

DVA:	DVA Approval Rules	Eligible Prescriber*
AR22	Limit of 3 every 6 months	S, RN, Physio, OT, LMO
DVA Comments	*For lymphoedema garments, health providers should have specialist post graduate training in oedema/lymphoedema management in order to access, measure, fit and review these garments.	



## Isotoner Therapeutic Pressure Gloves (pair)

- Washable lycra and spandex blend gives Isotoner gloves a comfortable fit while controlling swelling
- Use this glove anytime day or night and the gentle, even compression will soothe and reduce swollen aching hands
- Seamless support-seams are on the outside and away from pain-sensitive areas like the base of the thumb



DVA: AR22

Size	Palm (cm)	Code (open finger)	Code (full finger)
Small	17 - 19	FBS301159	FBS301142
Medium	19 - 22	FBS301160	FBS301143
Large	22 - 24	FBS301161	FBS301144

Measure (cm) around palm (widest part of hand)

- 2-way stretch provides gentle compression
- Isotoner therapeutic glove compression is considered moderate: **23 - 32mmHg**



## Norco Oedema Glove (each)



DVA: AR22

Size	Palm (cm)	Full Finger				Open Finger	
		1. Wrist		2. Over Wrist		3. Over Wrist	
		Left	Right	Left	Right	Left	Right
XS	18	-	-	FBS301151	FBS301152	FBS301162	FBS301163
S	20	FBS301145	FBS301146	FBS301153	FBS301154	FBS301164	FBS301165
M	23	FBS301147	FBS301148	FBS301155	FBS301156	FBS301166	FBS301167
L	25	FBS301149	FBS301150	FBS301157	FBS301158	FBS301168	FBS301169

Measure (cm) around palm (widest part of hand).

- Made of nylon/lycra with seams on the outside for smooth oedema control
- Mild compression **15 - 25mmHg**
- Closed finger style available in wrist length or over-the-wrist
- Open finger styles available in over-the-wrist and full arm styles
- Sold individually

### DVA Contact Details

P 1300 888 052 | F 1300 787 052 | E [dva@aidacare.com.au](mailto:dva@aidacare.com.au)



For NDIS Item Code, refer to page: 508



## Handeze Support Gloves (pair)



DVA: AR22

- The unique four-way stretch fabric provides three main proven pain relievers: heat, support and massage
- The Handeze glove traps natural body heat, which stimulates blood circulation in wrist, hand and fingers. This reduces swelling and helps maintain flexibility
- Made of modified lycra fabric
- The form-fitting design provides additional support for the muscles, tendons and ligaments of the hand and wrist

Size	Knuckles (cm)	Colour	Code
Extra Small	Up to 7.0	Beige	FBS301170
		Slate	FBS301170G0
Small	6.5 - 8.0	Beige	FBS301170S1
		Slate	FBS301170G1
Medium	7.5 - 9.5	Beige	FBS301170S2
		Slate	FBS301170G2
Large	8.5 - 11.0	Beige	FBS301170S3
		Slate	FBS301170G3

Measure the width hand across the four knuckles (not finger joints). Do not include the thumb

## Jobst - Medical Armwear



### Overview

Jobst upper limb garments focus on improving the quality of life for those suffering from lymphatic conditions

### To Order

Choose your preferred model, then use the Size Guide to select the appropriate size and code

## Jobst Bella Lite

- Soft and air-permeable
- Lightweight knit construction
- Fits a wide range of hand and arm shapes
- Fits both the left or right arm/hand
- The combination sleeve/glove can be worn separately together

## Jobst Bella Lite - Standard Arm Sleeve (20 - 30mmHg)



DVA: AR22

Size	Size Guide			Code	
	Wrist (cm)	Mid-Lower Arm (cm)	Mid-Upper Arm (cm)	Regular (length up to 43cm)	Long (length over 43cm)
Small	14 - 20	18 - 23	22 - 40	FBS303479	FBS303478
Medium	16 - 22	23 - 29	27 - 45	FBS303481	FBS303480
Large	18 - 24	29 - 34	33 - 51	FBS303483	FBS303482

**Measurement:** Wrist and arm measurements are circumferences. Length is from axilla to wrist

## Jobst Bella Lite - Combination Sleeve/Glove (20 - 30mmHg)



DVA: AR22

Size	Size Guide			Code	
	Palm (cm)	Mid-Lower Arm (cm)	Mid-Upper Arm (cm)	Regular (length up to 43cm)	Long (length over 43cm)
Small	15 - 19	18 - 23	22 - 40	FBS303484	FBS303487
Medium	19 - 22	23 - 29	27 - 45	FBS303485	FBS303488
Large	22 - 26	29 - 34	33 - 51	FBS303486	FBS303489

**Measurement:** Palm and arm measurements are circumferences. Length is from axilla to wrist

### General Enquiries

P 1300 133 120 | E sales@aidacare.com.au | W www.aidacare.com.au



## Jobst Bella Strong

- Ideal for managing moderate upper extremity lymphoedema
- Donning device included with every sleeve for easy donning
- Open knit structure allows for improved air permeability which keeps skin dry
- Two-way stretch makes the arm sleeve comfortable without compromising medical efficacy
- Circular knit construction
- Cotton-like feel; feels soft to the skin
- Dotted, 2" silicone band keeps sleeve firmly in place

### Jobst Bella Strong - Standard Arm Sleeve (20 - 30mmHg)



DVA: AR22

Size	Size Guide			Code	
	Wrist (cm)	Mid-Forearm (cm)	Axilla (cm) (Top of Arm)	Regular (length up to 43cm)	Long (length over 43cm)
1	14 - 18	17 - 21	22 - 31	FBS303458	FBS303468
2	14 - 18	17 - 21	31 - 41	FBS303459	FBS303469
3	14 - 18	21 - 25	25 - 34	FBS303460	FBS303470
4	16 - 19	21 - 25	28 - 38	FBS303461	FBS303471
5	17 - 20	21 - 25	34 - 43	FBS303462	FBS303472
6	14 - 18	25 - 29	29 - 38	FBS303463	FBS303473
7	17 - 20	25 - 29	33 - 43	FBS303464	FBS303474
8	18 - 21	25 - 29	38 - 48	FBS303465	FBS303475
9	16 - 19	29 - 33	32 - 42	FBS303466	FBS303476
10	19 - 22	29 - 33	36 - 46	FBS303467	FBS303477



**Measurement:** Wrist, arm and axilla measurements are circumferences. Length is from axilla to wrist

### Jobst Bella Strong - Gauntlet (20 - 30mmHg)



DVA: AR22

Size	Size Guide		Code
	Wrist (cm)	Palm (cm)	
1	14 - 18	15 - 17	PTS642534
2	14 - 18	17 - 19	PTS642535
3	18 - 21	17 - 19	PTS642536
4	14 - 18	19 - 21	PTS642537
5	18 - 21	19 - 21	PTS642538
6	16 - 19	21 - 23	PTS642539
7	19 - 22	21 - 23	PTS642540
8	19 - 22	23 - 26	PTS642541



**Measurement:** Wrist and palm measurements are circumferences



## Jobst Elvarex

- JOBST Elvarex garments feature a special low-stretch, 'double-knit' fabric, which exerts a light massaging effect on the initial lymphatics, and minimises re-oedematisation
- The high cotton content, flat knit construction and short stretch thread means that Elvarex products provide a good anatomical fit with maximum comfort
- A variety of styles available including: Standard Arm Sleeve; Arm Sleeve with Bra Attachment; Arm Sleeve with Shoulder Strap; Hand Piece with and without Fingers
- Available in **beige**



### Jobst Elvarex - Standard Arm Sleeve (20 - 30mmHg)



DVA: AR22

Size	Size Guide					Code	
	Wrist (cm) (Narrowest Part)	Mid-Lower Arm (cm)	Elbow Crease (cm)	Mid-Upper Arm (cm)	Top of Arm (cm) (Below Armpit)	Left	Right
Small	16 - 18	23 - 26	24 - 26	26 - 29	31 - 34	PTS642150	PTS642149
Medium	18 - 20	26 - 28	26 - 29	29 - 33	34 - 38	PTS642152	PTS642151
Large	20 - 23	28 - 30	29 - 32	33 - 37	38 - 44	PTS642154	PTS642153

**Measurement:** All measurements are circumferences

### Jobst Elvarex - Arm Sleeve with Bra Attachment (20 - 30mmHg)



DVA: AR22

Size	Size Guide					Code	
	Wrist (cm) (Narrowest Part)	Mid-Lower Arm (cm)	Elbow Crease (cm)	Mid-Upper Arm (cm)	Top of Arm (cm) (Below Armpit)	Left	Right
Small	16 - 18	23 - 26	24 - 26	26 - 29	31 - 34	PTS642162	PTS642161
Medium	18 - 20	26 - 28	26 - 29	29 - 33	34 - 38	PTS642164	PTS642163
Large	20 - 23	28 - 30	29 - 32	33 - 37	38 - 44	PTS642166	PTS642165

**Measurement:** All measurements are circumferences

### Jobst Elvarex - Arm Sleeve with Shoulder Strap (20 - 30mmHg)



DVA: AR22

Size	Size Guide					Code	
	Wrist (cm) (Narrowest Part)	Mid-Lower Arm (cm)	Elbow Crease (cm)	Mid-Upper Arm (cm)	Top of Arm (cm) (Below Armpit)	Left	Right
Small	16 - 18	23 - 26	24 - 26	26 - 29	31 - 34	PTS642156	PTS642155
Medium	18 - 20	26 - 28	26 - 29	29 - 33	34 - 38	PTS642158	PTS642157
Large	20 - 23	28 - 30	29 - 32	33 - 37	38 - 44	PTS642160	PTS642159

**Measurement:** All measurements are circumferences

### Jobst Elvarex - Handpiece with Thumb (20 - 30mmHg)



DVA: AR22

Size	Size Guide				Code	
	Hand (cm) (at knuckles)	Palm (cm) (widest part)	Wrist (cm) (narrowest part)	Thumb (cm) (at base)	Left	Right
Small	16 - 18	17 - 19	16 - 18	5 - 6	PTS642168	PTS642167
Medium	17.5 - 19.5	19 - 21	18 - 20	6 - 7	PTS642170	PTS642169
Large	19.5 - 20.5	21 - 23	20 - 22	7 - 8	PTS642172	PTS642171

**Measurement:** All measurements are circumferences

### Jobst Elvarex - Handpiece with Fingers (20 - 30mmHg)

- Note: For correct sizing, use the Handpiece Size Guide above and the below Size Guide



DVA: AR22

Size	Size Guide				Code	
	Index Finger (cm) (at base)	Middle Finger (cm) (at base)	Ring Finger (cm) (at base)	Little Finger (cm) (at base)	Left	Right
Small	5 - 6	5 - 6	4.5 - 5.5	4 - 5	PTS642174	PTS642173
Medium	6 - 7	6 - 7	5.5 - 6.5	5 - 6	PTS642176	PTS642175
Large	6 - 7	6.5 - 7	6.5 - 7.5	6 - 7	PTS642178	PTS642177

**Measurement:** All measurements are circumferences

#### General Enquiries

P 1300 133 120 | E sales@aidacare.com.au | W www.aidacare.com.au



## Mediven

- Mediven Harmony uses a unique fabric that is soft to touch, clinically effective and easy to apply
- It features a new design that incorporates a double ellipse - one in the crease and one on the point of the elbow - for maximum patient comfort
- Seamless, soft fibre offers a comfortable fit
- RAL compression classes 1 and 2



### To Order

Choose your preferred model, then use the appropriate Size Guide to select the appropriate size and code

### Mediven Harmony - Arm Sleeve (CG)

- CG Arm Sleeves stop at the wrist
- The CG Arm Sleeve is available in 3 styles: Arm Sleeve, Arm Sleeve with Top Band, Arm Sleeve with Shoulder cap
- Colour available: **Caramel**
- Compression: 18 - 21 mmHg and 23 - 32mmHg



Arm Sleeve



Arm Sleeve w Top Band



Arm Sleeve w Shoulder cap

	Size Guide							
	Size 1	Size 2	Size 3	Size 4	Size 5	Size 6	Size 7	Size 8
Top of Arm (cm)	25.5- 28	28 - 30.5	30 - 33	32 - 35	33.5 - 36.5	36 - 39.5	38 - 41.5	40.5 - 44.5
Elbow (cm)	23 - 25	24.5 - 26.5	26 - 28.5	27.5 - 30	29 - 31.5	30.5 - 33.5	32.5 - 35.5	35 - 38.5
Wrist (cm)	13.5 - 14.5	14.5 - 15.5	16 - 17.5	17.5 - 19	19 - 20.5	20.5 - 22.5	22.5 - 24.5	25 - 27.5

**Measurement:** All measurements are circumferences and are in cm



DVA: AR22

Size	Class 1 (18 - 21 mmHg)			Class 2 (23 - 32 mmHg)		
	CG Arm Sleeve	CG Arm Sleeve with Top Band	CG Arm Sleeve with Shoulder cap	CG Arm Sleeve	CG Arm Sleeve with Top Band	CG Arm Sleeve with Shoulder cap
1	FBS303000	FBS303280	FBS303152	FBS303032	FBS303312	FBS303216
2	FBS303001	FBS303281	FBS303153	FBS303033	FBS303313	FBS303217
3	FBS303002	FBS303282	FBS303154	FBS303034	FBS303314	FBS303218
4	FBS303003	FBS303283	FBS303155	FBS303035	FBS303315	FBS303219
5	FBS303004	FBS303284	FBS303156	FBS303036	FBS303316	FBS303220
6	FBS303005	FBS303285	FBS303157	FBS303037	FBS303317	FBS303221
7	FBS303006	FBS303286	FBS303158	FBS303038	FBS303318	FBS303222
8	FBS303007	FBS303287	FBS303159	FBS303039	FBS303319	FBS303223

#### DVA Contact Details

P 1300 888 052 | F 1300 787 052 | E [dva@aidacare.com.au](mailto:dva@aidacare.com.au)



For NDIS Item Code, refer to page: 508



## Mediven Harmony - Arm Sleeve (CG) - Extra Wide

- The Extra Wide CG Arm Sleeve can accommodate increased swelling
- CG Arm Sleeves stop at the wrist
- The CG Arm Sleeve is available in 3 styles: Arm Sleeve, Arm Sleeve with Top Band, Arm Sleeve with Shoulder cap
- Colour available: **Caramel**
- Compression: 18 - 21mmHg and 23 - 32mmHg

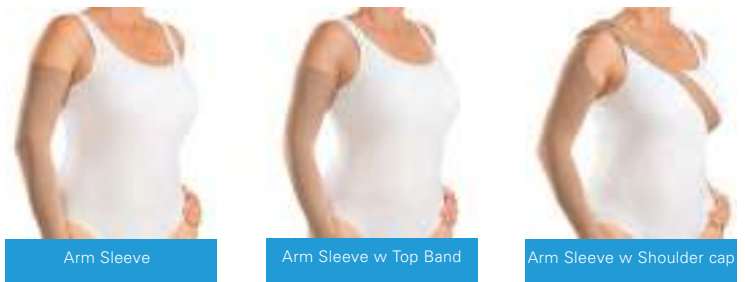

Size Guide								
	Size 1	Size 2	Size 3	Size 4	Size 5	Size 6	Size 7	Size 8
Top of Arm (cm)	28.5 - 31	30.5 - 33.5	33 - 36	35 - 38.5	37 - 40.5	39.5 - 43	41.5 - 45.5	45 - 49.5
Elbow (cm)	24 - 26	26.5 - 29	28.5 - 31	30 - 33	31.5 - 34.5	33.5 - 36.5	35.5 - 39	38.5 - 42
Wrist (cm)	13.5 - 14.5	14.5 - 15.5	16 - 17.5	17.5 - 19	19 - 20.5	20.5 - 22.5	22.5 - 24.5	25 - 27.5

**Measurement:** All measurements are circumferences and are in cm



DVA: AR22

Size	Class 1 (18 - 21 mmHg)			Class 2 (23 - 32 mmHg)		
	CG Arm Sleeve (Extra Wide)	CG Arm Sleeve with Top Band (Extra Wide)	CG Arm Sleeve with Shoulder cap (Extra Wide)	CG Arm Sleeve (Extra Wide)	CG Arm Sleeve with Top Band (Extra Wide)	CG Arm Sleeve with Shoulder cap (Extra Wide)
	Code					
1	FBS303016	FBS303296	FBS303168	FBS303048	FBS303328	FBS303232
2	FBS303017	FBS303297	FBS303169	FBS303049	FBS303329	FBS303233
3	FBS303018	FBS303298	FBS303170	FBS303050	FBS303330	FBS303234
4	FBS303019	FBS303299	FBS303171	FBS303051	FBS303331	FBS303235
5	FBS303020	FBS303300	FBS303172	FBS303052	FBS303332	FBS303236
6	FBS303021	FBS303301	FBS303173	FBS303053	FBS303333	FBS303237
7	FBS303022	FBS303302	FBS303174	FBS303054	FBS303334	FBS303238
8	FBS303023	FBS303303	FBS303175	FBS303055	FBS303335	FBS303239

## Mediven Harmony - Combined Arm Sleeve (AG)

- AG Arm Sleeves incorporate a gauntlet
- The AG Arm Sleeve is available in 3 styles: Arm Sleeve, Arm Sleeve with Top Band, Arm Sleeve with Shoulder cap
- Colour available: **Caramel**
- Compression: 18 - 21mmHg and 23 - 32mmHg



Size Guide								
	Size 1	Size 2	Size 3	Size 4	Size 5	Size 6	Size 7	Size 8
Top of Arm (cm)	25.5 - 28	28 - 30.5	30 - 33	32 - 35	33.5 - 36.5	36 - 39.5	38 - 41.5	40.5 - 44.5
Elbow (cm)	23 - 25	24.5 - 26.5	26 - 28.5	27.5 - 30	29 - 31.5	30.5 - 33.5	32.5 - 35.5	35 - 38.5
Wrist (cm)	13.5 - 14.5	14.5 - 15.5	16 - 17.5	17.5 - 19	19 - 20.5	20.5 - 22.5	22.5 - 24.5	25 - 27.5
Palm (cm)	15 - 18	16 - 19	17 - 20	19 - 22	20 - 23	22 - 25	24 - 27	26 - 29

**Measurement:** All measurements are circumferences and are in cm

### General Enquiries

P 1300 133 120 | E sales@aidacare.com.au | W www.aidacare.com.au



## Mediven Harmony - Combined Arm Sleeve (AG) (contd)



DVA: AR22

Size	Class 1 (18 - 21 mmHg)			Class 2 (23 - 32 mmHg)		
	AG Arm Sleeve	AG Arm Sleeve with Top Band	AG Arm Sleeve with Shoulder cap	AG Arm Sleeve	AG Arm Sleeve with Top Band	AG Arm Sleeve with Shoulder cap
Code						
1	FBS303088	FBS303344	FBS303184	FBS303120	FBS303376	FBS303248
2	FBS303089	FBS303345	FBS303185	FBS303121	FBS303377	FBS303249
3	FBS303090	FBS303346	FBS303186	FBS303122	FBS303378	FBS303250
4	FBS303091	FBS303347	FBS303187	FBS303123	FBS303379	FBS303251
5	FBS303092	FBS303348	FBS303188	FBS303124	FBS303380	FBS303252
6	FBS303093	FBS303349	FBS303189	FBS303125	FBS303381	FBS303253
7	FBS303094	FBS303350	FBS303190	FBS303126	FBS303382	FBS303254
8	FBS303095	FBS303351	FBS303191	FBS303127	FBS303383	FBS303255

## Mediven Harmony - Combined Arm Sleeve (AG) - Extra Wide

- The Extra Wide AG Arm Sleeve can accommodate increased swelling
- AG Arm Sleeves incorporate a gauntlet
- The AG Arm Sleeve is available in 3 styles: Arm Sleeve, Arm Sleeve with Top Band, Arm Sleeve with Shoulder cap
- Colour available: **Caramel**
- Compression: 18 - 21mmHg and 23 - 32mmHg



	Size Guide							
	Size 1	Size 2	Size 3	Size 4	Size 5	Size 6	Size 7	Size 8
Top of Arm (cm)	28.5 - 31	30.5 - 33.5	33 - 36	35 - 38.5	37 - 40.5	39.5 - 43	41.5 - 45.5	45 - 49.5
Elbow (cm)	24 - 26	26.5 - 29	28.5 - 31	30 - 33	31.5 - 34.5	33.5 - 36.5	35.5 - 39	38.5 - 42
Wrist (cm)	13.5 - 14.5	14.5 - 15.5	16 - 17.5	17.5 - 19	19 - 20.5	20.5 - 22.5	22.5 - 24.5	25 - 27.5
Palm (cm)	15 - 18	16 - 19	17 - 20	19 - 22	20 - 23	22 - 25	24 - 27	26 - 29

**Measurement:** All measurements are circumferences and are in cm



DVA: AR22

Size	Class 1 (18 - 21 mmHg)			Class 2 (23 - 32 mmHg)		
	AG Arm Sleeve (Extra Wide)	AG Arm Sleeve with Top Band (Extra Wide)	AG Arm Sleeve with Shoulder cap (Extra Wide)	AG Arm Sleeve (Extra Wide)	AG Arm Sleeve with Top Band (Extra Wide)	AG Arm Sleeve with Shoulder cap (Extra Wide)
Code						
1	FBS303104	FBS303360	FBS303200	FBS303136	FBS303392	FBS303264
2	FBS303105	FBS303361	FBS303201	FBS303137	FBS303393	FBS303265
3	FBS303106	FBS303362	FBS303202	FBS303138	FBS303394	FBS303266
4	FBS303107	FBS303363	FBS303203	FBS303139	FBS303395	FBS303267
5	FBS303108	FBS303364	FBS303204	FBS303140	FBS303396	FBS303268
6	FBS303109	FBS303365	FBS303205	FBS303141	FBS303397	FBS303269
7	FBS303110	FBS303366	FBS303206	FBS303142	FBS303398	FBS303270
8	FBS303111	FBS303367	FBS303207	FBS303143	FBS303399	FBS303271







## Mediven Harmony - AC1 Hand Part

- The AC1 Hand Part is available with or without compressive fingers
- Colour available: **Caramel**

Size Guide						
	Size 2	Size 3	Size 4	Size 5	Size 6	Size 7
Wrist	13.5 - 15.5	15 - 18	17 - 20	19 - 21	20 - 23.5	22.5 - 27.5
Palm	15 - 19	17 - 20	19 - 22	20 - 23	22 - 25	24 - 29

**Measurement:** All measurements are circumferences and are in cm

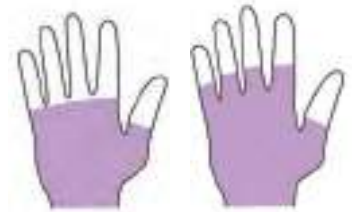

Compressive Fingers

Without Fingers



DVA: AR22

Size	Class 1 (18 - 21 mmHg)		Class 2 (23 - 32 mmHg)	
	Hand Part (with fingers)	Hand Part (without fingers)	Hand Part (with fingers)	Hand Part (without fingers)
	Code			
2	FBS303408	FBS303064	FBS303420	FBS303076
3	FBS303409	FBS303065	FBS303421	FBS303077
4	FBS303410	FBS303066	FBS303422	FBS303078
5	FBS303411	FBS303067	FBS303423	FBS303079
6	FBS303412	FBS303068	FBS303424	FBS303080
7	FBS303413	FBS303069	FBS303425	FBS303081

## Sigvaris

### To Order

Choose your preferred model. Then, order using: Code, Description, Style, Compression ( mmHg), Size

SIGVARIS

### Sigvaris - Traditional - Unisex

- The Traditional series is a reliable safe and effective option
- The elasticity and breathability mean that they are very comfortable to wear
- Colour available: **Beige**

Size Guide				
Size	Wrist (cm) (Narrowest Part)	Forearm (cm) (Mid-Forearm)	Upper Arm (cm) (Thickest Part)	Palm (cm) (Around Knuckles)
S	13 - 16	20 - 24	24 - 30	16 - 19
M	16 - 19	24 - 28	30 - 36	19 - 22
L	19 - 22	28 - 32	36 - 42	22 - 26

**Measurement:** All measurements are circumferences. Palm measurement only required for arm sleeves with mittens



DVA: AR22

Code	Description	Style	Compression 23 - 32 mmHg (Class 2)	Size
PTS642415	Traditional Sleeve	Without Mitten	✓	S / M / L
PTS642420	Traditional Sleeve	With Mitten	✓	S / M / L
PTS642445	Traditional Mitten	-	✓	S / M / L

### General Enquiries

P 1300 133 120 | E sales@aidacare.com.au | W www.aidacare.com.au



## Sigvaris - Advance - Unisex

- The Advance series has been developed with the help of patients and clinicians to create a garment that meets medical efficacy standards and exceeds expectations
- Constructed with a polyamide microfibre for extreme softness and anti-bacterial properties
- Colour available: **Light beige**



Size Guide			
Size	Wrist (cm) (narrowest part)	Mid-Upper Arm (cm) (mid-way between elbow & axilla)	Palm (cm) (around knuckles)
XS	13 - 14	24 - 32	16 - 20
S	14 - 16	26 - 34	17 - 21
M	16 - 18	29 - 37	18 - 22
L	18 - 20	32 - 40	19 - 23
XL	20 - 23	34 - 42	20 - 24

**Measurement:** All measurements are circumferences. Palm measurement only required for arm sleeves with mittens



DVA: AR22

Code	Description	Style	Compression ( mmHg)		Size
			14 - 18	20 - 25	
PTS642425	Advance Sleeve	Without Mitten	✓	✓	XS / S / M / L / XL
PTS642430	Advance Sleeve	With Mitten	✓	✓	XS / S / M / L / XL
PTS642435	Advance Sleeve with Grip Top	Without Mitten	✓	✓	XS / S / M / L / XL
PTS642440	Advance Sleeve with Grip Top	With Mitten	✓	✓	XS / S / M / L / XL

## Solaris



### Overview

- The Solaris brand offers a wide range of compression garments to suit users with different needs
- Their upper limb range includes: ReadyWrap, ExoStrong and Caresia

### To Order

Choose your preferred model, then use the appropriate Size Guide to select the appropriate size and code

## ReadyWrap (Inelastic Compression)

- Created to replace daytime compression bandaging or serve as an alternative/supplement to compression garments
- Inelastic materials produce high working pressure and low resting pressure
- Breathable and wickable materials ensure maximum comfort

## Solaris - ReadyWrap - Gauntlet

- Provides coverage from the wrist to the MCP (quarter finger) and overlaps the ReadyWrap arm garment to reduce gapping
- Left / Right specific design contours more naturally to the hand
- Pocket design allows for swell spots or foam pads to provide additional support



DVA: AR22



Size Guide					Code	
Size	Length (cm)	Wrist (cm)	Palm (cm)	Colour	Left	Right
Small	up to 12.5	13.5 - 17	18 - 20	Beige	FBS303663	FBS303671
				Black	FBS303664	FBS303672
Medium	up to 13.5	15.5 - 20	20 - 22	Beige	FBS303661	FBS303669
				Black	FBS303662	FBS303670
Large	up to 14.5	17.5 - 23	22 - 24	Beige	FBS303659	FBS303667
				Black	FBS303660	FBS303668
X Large	up to 15.5	19.5 - 26	24 - 26	Beige	FBS303665	FBS303673
				Black	FBS303666	FBS303674

**Measurement:** All measurements are circumferences

### DVA Contact Details

P 1300 888 052 | F 1300 787 052 | E [dva@aidacare.com.au](mailto:dva@aidacare.com.au)



For NDIS Item Code,  
refer to page: 508





## Solaris - ReadyWrap - Arm

- Double-sewn liner allows for easy, one-handed donning and doffing
- Bilateral design contours to both left and right arms
- Features a padded wrist and elbow to eliminate compression hot spots and provide additional comfort



DVA: AR22

Size Guide				Short (Arm length up to 43cm)	Average (Arm length up to 46cm)	Tall (Arm length up to 49.5cm)	
Size	Wrist (cm)	Elbow (cm)	Axilla (cm)	Colour	Code		
Small	13.5 - 17	19 - 26	22 - 29	Beige	FBS303687	FBS303689	FBS303691
				Black	FBS303688	FBS303690	FBS303692
Medium	15.5 - 20	24 - 33	26 - 36	Beige	FBS303681	FBS303683	FBS303685
				Black	FBS303682	FBS303684	FBS303686
Large	17.5 - 23	29 - 40	31 - 43	Beige	FBS303675	FBS303677	FBS303679
				Black	FBS303676	FBS303678	FBS303680
X Large	17.5 - 23	30 - 43	36 - 50	Beige	FBS303693	FBS303695	FBS303697
				Black	FBS303694	FBS303696	FBS303698

**Measurement:** All measurements are circumferences

## Solaris - ExoStrong (20 - 30 mmHg)

- ExoStrong garments are designed to move with you. With a functional design at the elbow, wrist and web spaces, you can enjoy the freedom to move
- ExoStrong provides **20 - 30mmHg** of compression
- Available in **beige**



## Solaris - ExoStrong - Arm



DVA: AR22

Size Guide				Short (Arm length up to 43cm)	Average (Arm length up to 46cm)	Tall (Arm length up to 49cm)	
Size	Wrist (cm)	Elbow (cm)	Upper Arm (cm)	Style	Code		
Small	15 - 17	24 - 27	27 - 30	Knit Top	FBS303564	FBS303572	FBS303580
				Silicone Top	FBS303565	FBS303573	FBS303581
Medium	17 - 19	27 - 31	31 - 35	Knit Top	FBS303566	FBS303574	FBS303582
				Silicone Top	FBS303567	FBS303575	FBS303583
Large	20 - 22	31 - 35	35 - 40	Knit Top	FBS303568	FBS303576	FBS303584
				Silicone Top	FBS303569	FBS303577	FBS303585
X Large	23 - 25	36 - 41	40 - 45	Knit Top	FBS303570	FBS303578	FBS303586
				Silicone Top	FBS303571	FBS303579	FBS303587

**Measurement:** All measurements are circumferences

## Solaris - ExoStrong - Glove & Gauntlet

Size Guide		Glove (to DIPs)	Gauntlet (to MCPs)
Size	Palm (cm)	Wrist (cm)	Code
Small	17 - 19	15 - 17	FBS303558S   FBS303559S
Medium	19 - 21	17 - 19	FBS303558M   FBS303559M
Large	22 - 24	20 - 22	FBS303558L   FBS303559L
X Large	25 - 27	23 - 25	FBS303558XL   FBS303559XL

**Measurement:** All measurements are circumferences

\*DIPs - Half finger

\*MCPs - Quarter Finger





## Solaris Caresia - Lymphoedema Compression Bandage Liners

- Caresia standard sized bandage liners simplify complex multi-layered bandaging protocols by replacing and improving upon foam liners, stockinette, and gauze
- Caresia over-wrapping is more comfortable and effective than standard bandaging during the active phase of therapy
- The unique foam chips used in every Caresia garment help resolve tissue induration, stimulate interstitial fluid movement, and diffuse irregular wrapping pressures



### Glove



DVA: AR22

Size Guide			
Size	Palm (cm)	Wrist (cm)	Code
S	15 - 19	13.5 - 16	FBS303590
M	19 - 23	16 - 22	FBS303589
L	23 - 28	22 - 28	FBS303588

**Measurement:** All measurements are circumferences

### Gauntlet



DVA: AR22

Size Guide			
Size	Palm (cm)	Wrist (cm)	Code
S	15 - 19	13.5 - 16	PTS642631
M	19 - 23	16 - 22	PTS642630
L	23 - 28	22 - 28	PTS642629

**Measurement:** All measurements are circumferences

### Arm - MCPs to Axilla



DVA: AR22

Size Guide				Code	
Size	Palm (cm)	Wrist (cm)	Biceps (cm)	Left	Right
				S	15 - 19
M	19 - 23	16 - 22	30 - 40	PTS642633	PTS642636
L	23 - 28	22 - 28	40 - 50	PTS642632	PTS642635

**Measurement:** All measurements are circumferences

\*MCPs - Quarter Finger

### Arm - Wrist to Axilla



DVA: AR22

Size Guide			
Size	Wrist (cm)	Biceps (cm)	Code
S	13.5 - 16	20 - 30	PTS642638
M	16 - 22	30 - 40	PTS642640
L	22 - 28	40 - 50	PTS642639

**Measurement:** All measurements are circumferences

## Solaris Swell Spots - Lymphoedema Pressure Pads

- Designed to be used under compression bandaging, to address areas of swelling, pad bony prominences, soften scars, or fill crevices
- Tailored (breast, foot, ankle, patella, thigh etc), and multi-function types are available to be used wherever is appropriate



DVA: AR22

Solaris Swell Spots	Dimensions	Code
Swell Spot - Curved	5 x 12cm	PTS642233
Swell Spot - Dorsal - (S)	9 x 14.5cm	PTS642234S
Swell Spot - Dorsal - (L)	9 x 18cm	PTS642234L
Swell Spot - Palmar - (S)	8.5 x 7cm	PTS642235S
Swell Spot - Palmar - (L)	9.5 x 8cm	PTS642235L
Swell Spot - Oval	8 x 19cm	PTS642236
Swell Spot - Katina - (S)	10 x 38cm	PTS642237
Swell Spot - Katina - (L)	18 x 42cm	PTS642238
Swell Spot - Sobol - (S)	18cm (diam)	PTS642239S
Swell Spot - Sobol - (L)	23cm (diam)	PTS642239L
Swell Spot - Jo-Ju	5 x 8cm	PTS642240
Swell Spot - Kimbe	25 x 15cm	PTS642241
Swell Spot - Breast - (S)	A - B cup	PTS642242S
Swell Spot - Breast - (M)	C - D cup	PTS642242M
Swell Spot - Breast - (L)	D - DD cup	PTS642242L
Swell Spot - Versi - Face	26 x 17cm	PTS642243

Solaris Swell Spots	Dimensions	Code
Swell Spot - Thora - Thigh	50 x 22cm	PTS642244
Swell Spot - Crescent - (S)	54(L) x 6.5(H) x 9(D)cm	PTS642245S
Swell Spot - Crescent - (M)	60(L) x 6.5(H) x 11(D)cm	PTS642245M
Swell Spot - Crescent - (L)	71(L) x 6.5(H) x 12(D)cm	PTS642245L
Swell Spot - We'a Toe - (S)	Up to 22cm (MTP Circ)	PTS642246S
Swell Spot - We'a Toe - (M)	Up to 25cm (MTP Circ)	PTS642246M
Swell Spot - We'a Toe - (L)	Up to 32cm (MTP Circ)	PTS642246L
Swell Spot - Female Labia	30 x 50cm	PTS642247
Swell Spot - Male Scrotum	30 X 50cm	PTS642248
Swell Spot - Lateral Bra	10 x 16cm	PTS642249
Swell Spot - LT Knee Shaper	35 x 65cm (Patella Girth)	PTS642250
Swell Spot - Sweet Spot	7 x 14cm	PTS642251
Swell Spot - Tic Tac - (S)	18 x 18cm	PTS642252S
Swell Spot - Tic Tac - (M)	28 x 28cm	PTS642252M
Swell Spot - Tic Tac - (L)	38 x 38cm	PTS642252L



## Solaris Tribute - Night

- Tribute custom-designed garments are essential for a successful lymphoedema home management program
- Worn nightly, Tribute garments eliminate the need for complex bandaging, and offer an effective solution to help regulate fluid fluctuations, decrease tissue turgor, assist a weakened lymphatic system, and maintain gains made in therapy
- Foam-filled channels in the garments create localised tissue stretch and pressure differential, opening the initial lymphatic gaps to encourage re-absorption of interstitial fluids and particles
- **Note:** Custom garments - require DVA prior approval on a case-by-case basis



Solaris Tribute - Night	Code
Fingertips to Axilla (20 mmHg)	PTS642223
Toes to Knee (20 mmHg)	PTS642224

## Flowtron 'Hydroven 3' Compression Pump

**hydroven**

### Application

- The 'Hydroven 3' intermittent pneumatic compression system treats a wide variety of vascular and lymphatic conditions, including venous ulceration, dependent and traumatic oedema and chronic venous insufficiency
- **Client should be assessed by a qualified medical professional before using this product.**

### Features

- Clinically effective, non-invasive dynamic compression
- Efficient use in both the clinic or home environment
- Three chamber leg or arm compression
- Adjustable pressure control provides tailored therapy to suit individual patients needs
- Pressure range of 30-110 mmHg
- Inflation/deflation cycle time of 90 seconds each
- Secure snap-lock connection of all garments to the pump promotes easy set up and prevents accidental disconnection
- Single tube attachment to each garment ensures less clutter

### Garments

- Hydroven's triple-chamber arm and leg garments provide gradient sequential compression, with 10% reduction in pressure in each chamber distally to proximally
- All garments can be used on either left or right limb, or two units can be used concurrently on both limbs



DVA: AR23

Product	Code
'Hydroven 3' Pump	MDC402100



DVA: AR26

Garments	Limb Garment	Inserts
Half leg 50cm	MDC402118	MDC402100
Full leg 66cm	MDC402119	MDC402110
Full leg 71cm	MDC402120	MDC402111
Full leg 76cm	MDC402121	MDC402112
Full leg 84cm	MDC402122	MDC402113
Full leg 92cm	MDC402123	MDC402114
Full arm 68cm	MDC402124	MDC402115
Full arm 78cm	MDC402125	MDC402116



## VenaPro Post-Op DVT Leg Pump

### Application

- A completely portable device which helps prevent post-operative DVT for moderate to high risk patients
- **Client should be assessed by a qualified medical professional before using this product.**

### Features

- Product comprises of **two** wrap-around leg units, one for each leg
- Each leg unit has an attached re-chargeable battery (5-6 hours)
- No tubes or cords – simple one button operation – weighs less than 0.5kg
- Graduated and asymmetric compression - applies 50mmHg once per minute



DVA: AR23

Product	Code
VenaPro Post-Op DVT Leg Pump	PTS642655



# NDIS Assessment & Assistive Technology

# Contents

- P 504 Introducing NDIS & Aidacare
- P 505 Assessment Form
- P 508 Product Index
- P 521 Maintenance & Service

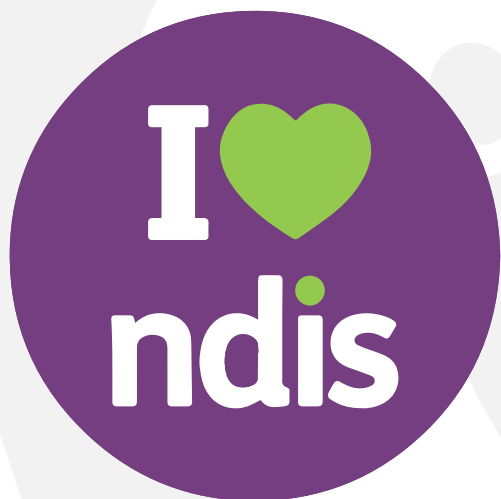

NDIS Catalogue also available,  
Contact Aidacare today to  
receive a copy!





## Aidacare, Your NDIS Assistive Technology Support Team

Aidacare is one of Australia's largest Healthcare Equipment and Service providers, offering practical solutions to clients who may be ageing-in-place, have an illness or living with a disability.

We work extensively with Healthcare Professionals and Care Providers in the Community, Home, Aged Care Facilities and Hospitals to identify and provide solutions to a range of challenges.

Our focus on product quality, services and ongoing support has made Aidacare & Aspire trusted brands throughout Australia, and that is why you will find us on many Government Healthcare Equipment Contracts and Private Healthcare Supply Agreements.



## Our Strengths

**Integrity:** Aidacare staff are trained to respond sensitively and helpfully to our clients' needs in the home and assisted-living environments. We are professional and conduct ourselves with integrity, so as to build long-term trusting and supportive partnerships.

**Total Quality:** Our internal training program for our staff at the "Aidacare University" ensures we provide the highest service and consistent equipment expertise. Our Quality Systems (ISO 9001) are supported by a rigorous Internal Audit Program.

### Service & Support:

We support what we sell. Our national Technical Service and Maintenance teams provide maintenance and asset management systems for Government Departments, Aged Care Facilities, Community Care providers and Hospitals.

### National Distribution with Local Service:

With Aidacare locations and Distribution Partner locations around the country, Aidacare has the network to support our customers wherever they are.

**NDIS Focus:** Aidacare are the Assistive Technology equipment experts who strive to offer a supportive and knowledgeable service to NDIS Participants, Healthcare Professionals and Case Managers.

This booklet is intended to assist in assessing the Participant's needs for assistive devices (AT), clinical equipment and home modifications, so that they can reach their goals.

Please refer to the information on the following pages to assist with the application and selection process



*Please Note: The following forms are available in an editable pdf format on the Aidacare Website*

## CONTACT DETAILS

### NDIS Participant Details

*Please complete ALL applicable fields*

Name \_\_\_\_\_ DOB \_\_\_\_\_

Address \_\_\_\_\_

NDIS Number \_\_\_\_\_ Phone Number \_\_\_\_\_ Email Address \_\_\_\_\_

Participant's NDIS Contact Name \_\_\_\_\_ Phone Number \_\_\_\_\_

### Clinician Contact Details

*Please complete ALL applicable fields*

Name \_\_\_\_\_ Phone Number \_\_\_\_\_

Occupation \_\_\_\_\_ Business Name \_\_\_\_\_ Email Address \_\_\_\_\_

### Plan Manager Details if not Agency or Self-Managed

Name \_\_\_\_\_ Phone Number \_\_\_\_\_

Email Address \_\_\_\_\_

## PARTICIPANT GOALS & ASPIRATIONS

Refer to goals in the participant's plan. Goals and aspirations should consider along with the environmental and personal context of the participant (living arrangements, community supports; social and economic participation).

*Please rank the goals in order of priority – most important at the top of the list, least important towards the bottom.*

Priority	Goal / Aspiration	Potential Assistive Technology (Refer to NDIS Product Selection Guide)





## EVALUATION / ASSESSMENT

### A. Background

*Note the participant's social and environmental circumstances with regard to use of Assistive Technology (AT)*

Participants Weight \_\_\_\_\_ kg      Participants Height \_\_\_\_\_ cm

Please list relevant medical information, including presenting condition: \_\_\_\_\_

Participant's Living Situation:      Lives Alone       Spouse       Other Family       Friend

Participant's Home Type:      House       Unit       Other  \_\_\_\_\_

Home Ownership Status:      Owner       Rents       Other  \_\_\_\_\_

Stairs to Access or in the Home:      Front Access       Rear Access       How Many Floor Levels \_\_\_\_\_

Other Considerations:      Narrow Doorway       Tight Corners       Other Restrictions? \_\_\_\_\_

### B. Function

*Outline the participant's functional limitation/s related to their disability which indicates the need for Assistive Technology. Relevant assessments should be conducted where required.*

Is assistance required to:	N	Y	If YES, AT that may be required	Refer to section in AT Selection Guide	Current AT & equipment in use
Mobilise?	<input type="checkbox"/>	<input type="checkbox"/>	Scooters	Scooters	
			Wheelchairs - Manual / Electric	Wheelchairs	
			Walkers & Frames	Mobility Aids	
Use stairs?	<input type="checkbox"/>	<input type="checkbox"/>	Rails	Home Mods	
			Stair Lift/Lift		
Get in / out of bed?	<input type="checkbox"/>	<input type="checkbox"/>	Electric Profiling Bed	Bedroom	
			Bedsticks / Poles / Support Rails		
Sit to stand?	<input type="checkbox"/>	<input type="checkbox"/>	Riser Recliner / Day Chairs	Chairs	
			Lifter / Transfer Aids	Lifters & Slings	
Get on / off the toilet?	<input type="checkbox"/>	<input type="checkbox"/>	Grab Rails	Home Mods	
			Toilet Aids	Bathroom & Toilet	
Bathe / shower?	<input type="checkbox"/>	<input type="checkbox"/>	Shower Commode	Bathroom & Toilet	
			Bath / Shower Aids		



## PRODUCT SELECTION SUMMARY

Once the relevant assessments are completed, list the AT recommended in order to meet the participant's goals. It is Good Practice to have equipment with electrical components and/or moving parts serviced at regular intervals to ensure safety, functionality and longevity. To avoid unforeseen and unbudgeted emergency breakdowns, Aidacare recommends including Preventative Maintenance and Repair costs in your participant plan. Please refer to schedules and pricing in Section 9 of this booklet.

Product Name	Product Code	Comments/Mods	Pg No.	NDIS Code	Priority Number of Goal	Quote Ref No.	Product Cost	Preventative Maintenance Costs
1								
2								
3								
4								
5								
6								
7								
8								
9								
10								
11								
12								
13								

**Equipment Trials:** Certain products are available for in-home evaluation & short-term trial. Please refer to the terms and conditions in Section 6 of this booklet.



## NDIS CODES QUICK REFERENCE GUIDE

This table is intended to assist Participants, Healthcare Professionals and Case Managers to easily identify NDIS codes for products and services commonly used in relation to equipment and home modifications.

Composite item codes are included for when several items are required in a specific area to meet the participant's needs ie: Manual wheelchair with head rest and seat cushion can be submitted against *Wheelchair Manual-Composite 05\_417\_0105\_1\_2*

NDIS Guide & Pricing Guide, please refer to [www.aidacare.com.au/contracts/national/ndis/](http://www.aidacare.com.au/contracts/national/ndis/)

## EQUIPMENT

### Bathroom & Toileting

Group	Item	Support Item Description	NDIS Item Code
Bath	Board	Bath board plastic no handle	05_093304076_0103_1_2
	Insert	Insert for reducing length or depth of a bathtub	05_093327083_0103_1_2
	Seat	Bath corner seat size 1	05_093305077_0103_1_2
	Support	Postural support inserted into a bath or placed on a stand, for a participant unable to sit or recline unaided safely - Over 5yr & Adult	05_093303079_0103_1_2
	Transfer Bench	Bath transfer bench no back	05_123121160_0103_1_2
Change Table	Electric	Change table-electronic	05_093312080_0103_1_2
	Manual	Change table manual	05_093312081_0103_1_2
Commode	Bedside - Folding	Bedside commode adjustable folding	05_091203047_0103_1_2
	Bedside - Height Adjust	Bedside commode adjustable height	05_091203048_0103_1_2
	Bedside - Wide	Bedside commode extra wide	05_091203049_0103_1_2
	Mobile - Low	Mobile shower commode - low transporter	05_091203053_0103_1_2
	Mobile - Self Propelled	Mobile shower commode - self propel folding	05_091203052_0103_1_2
	Seating	Custom made seating for shower commode or like bathroom item	05_093330084_0103_1_2
	Mobile Shower Commode - <b>Composite</b>		05_413_0103_1_2
Shower	Chair	Chair shower adjustable with arms wide	05_093307070_0103_1_2
	Chair - Swivel	Chair shower swivel type	05_093307072_0103_1_2
	Stool	Stool shower adjustable	05_093307073_0103_1_2
	Stool - Arms / Back	Stool shower adjustable with arms and/or back	05_093307074_0103_1_2
	Trolley	Specialised shower trolley	05_093312075_0103_1_2
	Shower Support - <b>Composite</b>		05_415_0103_1_2
Toilet	Bidet	Detachable. Equipment attached to toilet with air and water dispenser for washing following toileting	05_093318082_0103_1_2
	Seat Raiser	Seat toilet raise	05_091221067_0103_1_2
	Seat Raiser - Adjustable	Seat toilet raise adjustable	05_091221064_0103_1_2
	Seat Raiser - Adjustable Wide	Seat toilet raise adjustable wide	05_091221065_0103_1_2
	Seat Raiser - Fixed	Raised toilet seats fixed to toilet	05_091218063_0103_1_2
	Seat Raiser - Folding	Seat toilet raise folding	05_091221066_0103_1_2
	Support Arms	Arm supports and toilet back supports, free-standing	05_091225069_0103_1_2
	Support - Mounted	Arm and back supports mounted on toilet	05_091224068_0103_1_2
	Surround Adjustable	Toilet surround adjustable	05_091212061_0103_1_2
	Toilet Aids - <b>Composite</b>		05_414_0103_1_2



## Bedroom

Group	Item	Support Item Description	NDIS Item Code
Bed	Electric	Beds - power adjust, estimate	05_181210197_0103_1_2
	Electric - 4 Section	Beds - power adjust 4 section	05_181210198_0103_1_2
	Electric - Extra Width / Height	Beds - extra width or height power adjust	05_181210200_0103_1_2
	Electric - with Companion Bed	Hi-lo bed with second detachable bed for partner, detachment is to assist with care needs	05_181210201_0103_1_2
	Extension	Beds - extensions	05_181233208_0103_1_2
	Power Bed - <b>Composite</b>		05_423_0103_1_2
Bed Accessories	Blocks	Bed blocks	05_181212202_0103_1_2
	Cradle	Bed cradle- adjustable height	05_181221203_0103_1_2
	Rail Covers	Bed rails covers	05_181227206_0103_1_2
	Rail	Rails which attach to a bed to prevent the participant falling out. Price guidance is for one bed rail	05_181227207_0103_1_2
	Bed Table	Over bed table	05_180315322_0103_1_2
	Cushions - Positioning	Sleep system. Positioning cushions to help a participant maintain a consistent / optimal position while sleeping or resting	05_181224204_0103_1_2
	Wedges	Bed wedges (positioning)	05_181288205_0103_1_2
	Minor Bed - <b>Composite</b>		05_428_0103_1_2
Bed Transfer	Belt	Transfer belt	05_123115159_0105_1_2
	Ladder	Grip ladder	05_123112158_0105_1_2
	Pole	Bed pole for electric bed	05_123109157_0103_1_2
	Stick - Long	Bed sticks - Townsend long	05_123109156_0103_1_2
	Stick - Standard	Bed sticks - standard	05_123109155_0103_1_1
	Minor Bed - <b>Composite</b>		05_428_0103_1_2
Mattress	Alternating	Alternating pressure, low air loss for very complex needs, usually for participants in bed for most of the day and night	05_043306005_0103_1_2
	Foam / Air Combination	Pressure mattress air filled section	05_043306002_0103_1_2
	Overlay	Alternating or Static. Overlay with air or other substance, mechanical or not	05_043306004_0103_1_2
	Static	Mattress with pressure reduction properties	05_043306003_0103_1_2
	Power Bed - <b>Composite</b>		05_423_0103_1_2



NDIS Guide & Pricing Guide, please refer to [www.aidacare.com.au/contracts/national/ndis/](http://www.aidacare.com.au/contracts/national/ndis/)



## Chairs

Group	Item	Support Item Description	NDIS Item Code
Electric	Electric Lift	Chairs with in built mechanical or electric system to assist participant in movement to standing position	05_180903180_0103_1_2
Pressure Relieving	Air	Custom fit seating for people with body shape or pressure care needs to accommodate	05_180939183_0103_1_2
	Water	Chairs with full pressure relief via water filled inserts	05_043318006_0103_1_2
	Custom Seating	Lounge chairs with moulded seating. Custom fit seating for people with body shape or pressure care needs to accommodate	05_180921181_0103_1_2
	Custom Seating - Modular	Modular seating systems. Custom fit seating for people with body shape or pressure care needs to accommodate	05_180939182_0105_1_2

## Daily Living Aids

Group	Item	Support Item Description	NDIS Item Code
Personal Care	Dressing Aid	One or more small devices to assist with dressing and undressing	05_090900046_0103_1_2
	Bath & Grooming Aids	Bathing care and grooming aids	05_093300317_0103_1_2
	Safety & Personal Care	Includes other reasonable and necessary personal care and safety equipment not listed, due to impact of participant's disability.	05_098800044_0103_1_2
Cognitive Aids	Clock	Adapted clocks	05_222712259_0123_1_2
	Reminder	Programmable memory aids	05_222716260_0123_1_2
Environment Control	System	Environmental control systems	05_241303281_0123_1_2
	Wireless	ECU controlled wireless mains socket	05_241303282_0123_1_2
	Software	Environmental control software	05_241306283_0123_1_2
Cleaning	Dish Washing	One or more assistive devices to assist with dish washing, such as adapted dish cloths, utensils, detergent dispensers etc	05_150600320_0123_1_2
	Other & Maintenance	Other equipment specially selected due to the persons disability that enables them to perform household tasks like cleaning or maintenance	05_158800321_0123_1_2
Eating & Drinking	Aids	Adapted cups, spoons, cutlery and other assistive products for eating and drinking	05_150900319_0103_1_2
	Food Preparation	Small devices to assist with food and drink preparations - Includes adapted cooking utensils and basic appliances	05_150300318_0103_1_2



NDIS Guide & Pricing Guide, please refer to [www.aidacare.com.au/contracts/national/ndis/](http://www.aidacare.com.au/contracts/national/ndis/)



## Manual Handling & Transfer

Group	Item	Support Item Description	NDIS Item Code
Hoists / Lifters	Mobile	Hoist - mobile, standing position	05_123604167_0105_1_2
	Mobile - Sitting	Hoist mobile, sitting position solid seat	05_123606168_0105_1_2
	Fixed - Ceiling / Wall	Hoist- fixed to wall floor or ceiling	05_123612169_0105_1_2
	<b>Hoist - Composite</b>		05_420_0105_1_2
Slings	Full Body	Sling - full body	05_123603165_0105_1_2
	General Purpose	Sling - divided leg (with/without head support)	05_123603164_0105_1_2
	Specialised	Sling - specialist, including bariatric	05_123603166_0105_1_2
	Standing	Sling - band, standard	05_123603162_0105_1_2
	Toileting	Sling - toileting (with/without head support)	05_123603163_0105_1_2
	<b>Sling - Composite</b>		05_421_0105_1_2
Boards & Discs	Wood Board	Board transfer wood	05_123103152_0105_1_2
	Rotation Disc	Transfer turn table	05_123106154_0105_1_2
	Rotation Disc - Car	Car transfer pad	05_123103153_0105_1_2
	<b>Minor transfer - Composite</b>		05_430_0103_1_2
Slide Products	Slide Sheet	Transfer equipment- slide sheet	05_123103151_0105_1_2
Stretcher	Self-Propelled	Wheeled stretcher- self propelled	05_122718150_0105_1_2

## Mobility

Group	Item	Support Item Description	NDIS Item Code
Canes	Quad Stick	Quadrapod walking stick	05_120303086_0105_1_2
	Walking Stick	Walking sticks and canes	05_120303085_0105_1_2
	<b>Walking aids - Composite</b>		05_416_0105_1_2
Crutches	Elbow	Elbow crutches	05_120306087_0105_1_2
	Forearm	Forearm support crutches	05_120309088_0105_1_2
Frames & Rollators	Standing	Apparatus to hold a person in a standing position	05_053603009_0103_1_2
	Walking Frame	Walking frame	05_120603089_0105_1_2
	Walker - 6" Wheels	Wheeled walker - with frame 6" wheel	05_120606092_0105_1_2
	Walker - Gutter	Wheeled walker - with frame adult gutter	05_120606094_0105_1_2
	Walker - Mini	Rollator - mini	05_120606097_0105_1_2
	Walker - Posterior	Wheeled walker - posterior	05_120606095_0105_1_2
	Walker with Supports	Rollator with supports	05_120606098_0105_1_2
	Walker with Brakes & Seat	Four wheeled walker with brakes and seat	05_120606096_0105_1_2
	<b>Walking aids - Composite</b>		05_416_0105_1_2

NDIS Guide & Pricing Guide, please refer to [www.aidacare.com.au/contracts/national/ndis/](http://www.aidacare.com.au/contracts/national/ndis/)



## Scooters

Group	Item	Support Item Description	NDIS Item Code
Scooters	3 Wheeled	Scooters - 3 wheels	05_122303121_0105_1_2
	4 Wheeled	Scooters - 4 wheels	05_122303122_0105_1_2
	4 Wheeled Heavy Duty	Scooters - 4 wheels heavy duty	05_122303123_0105_1_2
	Scooter - <b>Composite</b>		05_418_0105_1_2

## Wheelchairs

Group	Item	Support Item Description	NDIS Item Code
Manual	Folding	Wheelchair- manually propelled - average folding	05_122203104_0105_1_2
	Folding	Wheelchair- manual - basic folding adult	05_122203105_0105_1_2
	Powered Assist	Manual wheelchair - powered wheels that amplify pushing effort	05_122212120_0105_1_2
	Tilt	Manual frame with seat and back rest able to be tipped as a unit past 90 degrees	05_122203115_0105_1_2
	Transit	Wheelchairs that cannot be self-propelled, so are propelled by an attendant	05_122203106_0105_1_2
	Wheelchair manual - <b>Composite</b>		05_417_0105_1_2
Manual Customised	Manual Rx	Frame is made to individual measurements	05_122203111_0105_1_2
	Amputee	Manual wheelchair. For example, balanced for lower limb amputee	05_122203118_0105_1_2
	Folding	Frame is made to individual measurements	05_122203108_0105_1_2
	Lightweight	Frame that is made to individual measurements. Made of titanium, aluminium or other lightweight material	05_122203113_0105_1_2
	One Arm	Manual wheelchair propelled by lever or dual hand rims	05_122209119_0105_1_2
	Custom Seating	Wheelchair and customised seating	05_122203117_0105_1_2
	Steel	Frame is made to individual measurements	05_122203112_0105_1_2
	Wheelchair manual - <b>Composite</b>		05_417_0105_1_2



NDIS Guide & Pricing Guide, please refer to [www.aidacare.com.au/contracts/national/ndis/](http://www.aidacare.com.au/contracts/national/ndis/)



**Wheelchairs Cont.**

Group	Item	Support Item Description	NDIS Item Code	
<b>ADULT</b>				
Powered	RWD Basic - Folding	Basic rear-wheel drive powered wheelchair which folds when disassembled, for adults	05_122306124_0105_1_2	
	RWD Basic	Rear-wheel drive basic powered wheelchair, for adults	05_122306125_0105_1_2	
	MWD Basic	Mid-wheel drive basic powered wheelchair, for adults	05_122306126_0105_1_2	
	RWD Tilt-in-Space	Rear-wheel drive with seat and back rest, able to be tipped as a unit past 90 degrees, for adults	05_122306129_0105_1_2	
	MWD Tilt-in-Space	Mid-wheel drive with seat and back rest, able to be tipped as a unit past 90 degrees, for adults	05_122306130_0105_1_2	
	RWD Tilt / Recline	Rear-wheel drive with seat and back rest, able to be tipped as a unit past 90 degrees & recline, for adults	05_122306134_0105_1_2	
	MWD Tilt / Recline	Mid-wheel drive with seat and back rest, able to be tipped as a unit past 90 degrees, for adults	05_122306135_0105_1_2	
	<b>BARIATRIC</b>			
	Bariatric - Over 200kg	Powered wheelchair for person with increased weight in obese range.	05_122306141_0105_1_2	
	<b>CHILD</b>			
	RWD Basic	Rear-wheel drive basic powered wheelchair for children	05_122306127_0105_1_2	
	MWD Basic	Mid-wheel drive basic powered wheelchair for children	05_122306128_0105_1_2	
	RWD Tilt-in-Space	Rear-wheel drive with seat and back rest able to be tipped as a unit past 90 degrees for children	05_122306132_0105_1_2	
MWD Tilt-in-Space	Mid-wheel drive with seat and back rest able to be tipped as a unit past 90 degrees for children	05_122306133_0105_1_2		
RWD Tilt / Recline	Rear-wheel drive with seat and back rest, able to be tipped as a unit past 90 degrees & recline.	05_122306136_0105_1_2		
MWD Tilt / Recline	Mid-wheel drive with seat and back rest, able to be tipped as a unit past 90 degrees & recline.	05_122306137_0105_1_3		
<b>SPECIALISED &amp; OTHER</b>				
Attendant Assist	Powered wheelchair with attendant control instead of or as well as participant control	05_122312142_0105_1_2		
4WD	Powered four-wheel drive wheelchair	05_122306140_0105_1_2		
Power Recline/Leg Elevation	Wheelchair- powered with powered recline or leg elevation	05_122306131_0105_1_2		
Power Seat Elevation	Wheelchair- powered with powered seat elevation	05_122306138_0105_1_2		



NDIS Guide & Pricing Guide, please refer to [www.aidacare.com.au/contracts/national/ndis/](http://www.aidacare.com.au/contracts/national/ndis/)





## Wheelchairs Cont.

Group	Item	Support Item Description	NDIS Item Code
Powered	Power Standing	Wheelchair- powered with powered standing mechanism	05_122306139_0105_1_2
	Stair Climbing	Wheelchair- powered stair climbing	05_122315143_0105_1_2
	Special Controls	Controls other than joy stick	05_122403144_0105_1_2
	Wheelchair powered - <b>Composite</b>		05_419_0105_1_2
Seating & Positioning	Air - Low	Air cushion low profile	05_181006189_0105_1_2
	Air - High	Air cushion high profile	05_181006188_0105_1_2
	Air - Other	Seat cushion- air cushion - other	05_181006187_0105_1_2
	Foam Combination	Combination cushion - gel, foam, and air	05_181006190_0105_1_2
	Custom Back Rest	Customised back rest with components individually aligned for participant	05_181003192_0105_1_2
	Wheelchair Head Rest	Head support for person with very high support needs due to high muscle tone or complete paralysis	05_181012191_0105_1_2
	Custom Back Rest - Moulded	Custom made - For example, moulded or shaped rest or seat	05_181003193_0105_1_2
	Custom Seating Postural	Custom made postural seating system - For example, moulded or shaped rest or seat	05_181088195_0105_1_2
	Custom Seating Postural	Customised postural seating system - For example, moulded or shaped back rest and seats with components individually aligned for participant	05_181088196_0105_1_2
	Pressure Care Cushion - <b>Composite</b>		05_429_0103_1_2
Wheelchair Other	Wheelchair Tray		05_181024194_0105_1_2
	Wheelchair Tie Downs	System to hold a wheelchair safely and steady whilst in transit	05_121224368_0109_1_2
	Wheelchair manual - <b>Composite</b>		05_417_0105_1_2
	Wheelchair powered - <b>Composite</b>		05_419_0105_1_2

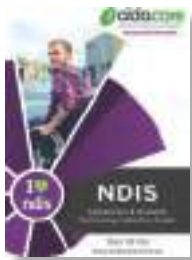

NDIS Guide & Pricing Guide, please refer to [www.aidacare.com.au/contracts/national/ndis/](http://www.aidacare.com.au/contracts/national/ndis/)



## Safety & Alarms

Group	Item	Support Item Description	NDIS Item Code
Alarms	Door / Other	Amplified, visual alert and/or vibratory alarms	05_222704219_0123_1_2
	Personal alarm - <b>Composite</b>		05_427_0103_1_2
Adaptive	Equipment	Daily adaptive equipment for personal Care & Safety	03_131_0103_1_1
	Furniture	Includes therapy cushions, conductive education furniture, hand grips mounted on furniture etc	05_188800051_0103_1_2
Protective Clothing	Helmets	Protective helmet for people with seizures or falls etc	05_090603045_0103_1_2
	Vest - Cooling	Vest used for people with thermoregulatory problems	05_043006001_0103_1_2

## Seating & Positioning

Group	Item	Support Item Description	NDIS Item Code
Cushions Air - Other	Air - Low	Air cushion low profile	05_181006189_0105_1_2
	Air - High	Air cushion high profile	05_181006188_0105_1_2
	Air - Other	Seat cushion- air cushion - other	05_181006187_0105_1_2
	Foam Combination	Combination cushion - gel, foam, and air	05_181006190_0105_1_2
Back Rest	Custom Back Rest	Customised back rest with components individually aligned for participant	05_181003192_0105_1_2
	Custom Back Rest - Moulded	Custom made - For example, moulded or shaped rest or seat	05_181003193_0105_1_2
Postural	Custom Seating Postural	Custom made postural seating system - For example, moulded or shaped rest or seat	05_181088195_0105_1_2
	Custom Seating Postural	Customised postural seating system - For example, moulded or shaped back rest and seats with components individually aligned for participant	05_181088196_0105_1_2

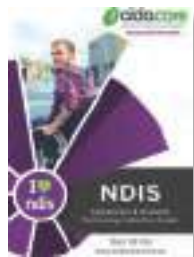

NDIS Guide & Pricing Guide, please refer to [www.aidacare.com.au/contracts/national/ndis/](http://www.aidacare.com.au/contracts/national/ndis/)



## Braces & Support

Group	Item	Support Item Description	NDIS Item Code
Hand	Splints - Short Term	Hand splints provided as part of a shorter term therapy program	05_060606010_0135_1_2
Arm	Splints - Various	Lycra or other splints designed to improve functioning	05_060688011_0135_1_2
Foot	Wheelchair Foot Support - Custom	Foot supports or restraints for a wheelchair where conventional supports do not suffice	05_061203014_0135_1_2
	Ankle	Ankle-foot orthoses ankle joint	05_061206019_0135_1_2
	Ankle/Foot	Ankle-foot orthoses prefabricated- average price	05_061206016_0135_1_2
	Ankle/Foot Small	Ankle-foot orthoses prefabricated sizes 1-4	05_061206017_0135_1_2
Leg	Ankle/Foot Reg - XLarge	Ankle-foot orthoses prefabricated reg, large, xlge	05_061206018_0135_1_2
	Ankle/Foot - Custom	Ankle-foot orthoses (AFO) static custom made	05_061206020_0135_1_2
	Foot Orthoses		05_061203015_0135_1_2
	Lower Limb - Dynamic	Lower limb orthotic - dynamic/lycra	05_061218013_0135_1_2
	Lower Limb	Leg orthoses	05_061213023_0135_1_2
	Knee	Knee-ankle-foot orthoses	05_061212022_0135_1_2
	Knee/Ankle/Foot	Knee orthoses	05_061209021_0135_1_2
	Hip/Knee/Ankle	Hip-knee-ankle-foot orthoses	05_061218027_0135_1_2
Other	Hip/Knee	Hip-knee orthoses	05_061216025_0135_1_2
	Hip	Hip orthoses	05_061215024_0135_1_2
Shoes	Thigh	Thigh orthoses	05_061217026_0135_1_2
	Body - Dynamic	Body orthotic - dynamic/lycra	05_060318012_0135_1_2
	Spine/Hip/Knee/Ankle	Thoracolumbar/lumbo-sacral - hip - knee - ankle - foot orthoses	05_061219028_0135_1_2
	Orthopaedic Shoes - Raised	Adjustments to regular shoes required due to disability, to add to the length of the leg and foot i.e. shoe raise	05_061203043_0135_1_2
Shoes	Orthopaedic Shoes - Extra Width/Depth	Pair of shoes with extra depth or width that are commercially available - to compensate for muscle weakness/activity	05_061203042_0135_1_2
	Orthopaedic Shoes - Custom	Customised pair of shoes made for a participant who is unable to fit off-the-shelf or specialist shoes	05_061203041_0135_1_2
	Orthoses - <b>Composite</b>		05_410_0135_1_2



NDIS Guide & Pricing Guide, please refer to [www.aidacare.com.au/contracts/national/ndis/](http://www.aidacare.com.au/contracts/national/ndis/)



## RENTALS

Group	Item	Support Item Description	NDIS Item Code
Multi	Rental - <b>Composite</b>		05_424_0105_1_2
Bathroom & Toilet		Short term rental or hire of bathroom or toilet equipment	05_800912344_0103_1_2
Bed & Mattress		Bed and mattress rental - per week	05_801812347_0103_1_2
Communication		Electronic Communication Unit rental	05_802413323_0123_1_2
Mobility	General	Short term rental of personal mobility equipment, quote not required but marked this way to allow price adjustment	05_805012350_0105_1_2
	Frames - Seating / Standing	Seating/standing frame equipment rental	05_801809436_0103_1_2
	Walking	Walking equipment rental	05_801206345_0105_1_2
Other	Flexible Package	Flexible equipment package (for changing need) - annual amount	05_801288434_0103_1_2
Transfer	Rental - Transfer	Transfer equipment rental - per week	05_801236346_0105_1_2
Vehicle	Adaptive Vehicle	Rental of adapted vehicle	05_353_0108_1_2

## SERVICES

### Repairs

Group	Item	Support Item Description	NDIS Item Code
After Hours	Non-Mobility	Repairs - personal care/safety, after-hours (one unit)	05_501288435_0105_1_2
Bathroom	Bath & Toilet	Repairs to any toileting and bathing equipment	05_500933306_0103_1_2
Bed	Electric	Electric bed repair	05_501812311_0103_1_2
	Battery / Charger	Battery or charger	05_501224310_0105_1_2
	Major	Mobility domain, wheeled mobility major repair - Includes repairs for chairs usually over 4 years old, which may require work on actuators or other parts	05_501200308_0105_1_2
	Standard	Mobility domain, wheeled mobility minor repair - Smaller repairs on newer chairs recently past warranty	05_501200307_0105_1_2
	Tyres	Tyres	05_501224309_0105_1_2
Transfer	After Hours		05_500433443_0103_1_2
	Standard	Transfer equipment repair	05_501236025_0105_1_2
	Hoist	Hoist repair- mobile or portable	01_501236025_0103_1_1
Feeding Equipment		HEN equipment repairs	03_501509092_0103_1_1



NDIS Guide & Pricing Guide, please refer to [www.aidacare.com.au/contracts/national/ndis/](http://www.aidacare.com.au/contracts/national/ndis/)



**Delivery / Set-Up / Training**

Group	Item	Support Item Description	NDIS Item Code	
Training		Training for carers in matters related to caring for a person with disability	15_038_0117_1_3	
Post		General satchel/post delivery of equipment to a participant	05_71888439_0103_1_2	
Delivery	Metro	Delivery of continence items in regional Metropolitan areas - expected maximum up to 4 deliveries per year. Price guidance is per Delivery	03_710930094_0103_1_1	
	Non-Metro	Delivery of continence items in regional and remote areas - expected maximum up to 4 deliveries per year. Price guidance is per delivery	03_710930093_0103_1_1	
	Bathroom & Toilet	Equipment delivery and removal from wrapping ready for use	05_710912335_0103_1_2	
	Bed / Mattress	Bed/ mattress equipment delivery and removal from wrapping ready for use	05_711812339_0103_1_2	
	Elec Communication	Equipment delivery and removal from wrapping ready for use	05_712413341_0123_1_2	
	Wheelchairs & Other Mobility	Equipment delivery and removal from wrapping ready for use	05_715012343_0105_1_2	
	Transfer & Manual Handling	Equipment delivery and removal from wrapping ready for use	05_711236337_0105_1_2	
	Seating & Standing Frames	Equipment delivery, removal from wrapping, fitting/adjusting for participant's disability specific needs and or training	05_701809328_0103_1_2	
	Walking	Equipment delivery and removal from wrapping ready for use	05_711206336_0105_1_2	
	Feeding Equipment	HEN equipment delivery	03_711509095_0103_1_1	
		Delivery/Set up - <b>Composite</b>		05_422_0105_1_2
	Delivery Setup & Training	Bed / Mattress	Equipment delivery, removal from wrapping, fitting/adjusting for the participant's disability specific needs and/or training in usage	05_701812329_0103_1_2
		Bathroom & Toilet	Equipment delivery, removal from wrapping, fitting/adjusting for participant's disability specific needs and or training	05_700912325_0103_1_2
Elec Communication		Equipment delivery, removal from wrapping, fitting/adjusting for participant disability specific needs and/ or training	05_702413331_0123_1_2	
Mobility - Walking		Equipment delivery, removal from wrapping, fitting/adjusting for participant's disability specific needs and or training	05_701206326_0105_1_2	
Wheelchairs & Other Mobility		Equipment delivery, removal from wrapping ready, fitting/adjusting for participant and or training	05_705012333_0105_1_2	
Transfer & Manual Handling		Equipment delivery, removal from wrapping ready, fitting/adjusting for participant and or training	05_701236327_0105_1_2	
Seating & Standing Frames		Equipment delivery, removal from wrapping ready, fitting/adjusting for participant and or training	05_701809338_0103_1_2	



NDIS Guide & Pricing Guide, please refer to [www.aidacare.com.au/contracts/national/ndis/](http://www.aidacare.com.au/contracts/national/ndis/)



## HOME MODIFICATIONS

Group	Item	Support Item Description	NDIS Item Code
Miscellaneous	Minor Low Cost	Lower cost minor miscellaneous adjustments and adaptations such as door adjustments, safety installations and bathroom fittings	06_182488380_0111_2_2
Lifts Elevators	Elevator	Elevator - home	06_183003384_0111_2_2
	Platform	Platform attached to stairs or vertical drop which a wheelchair or scooter rides on	06_183005385_0111_2_2
	Platform - Free Standing	Free standing vertical non-enclosed lifting platform similar to a lift usually traversing smaller distances than an enclosed lift/ elevator	06_183007386_0111_2_2
	Stairs - Platform	Stair lift with platform attached to rail or track to traverse person over stairs to upper or lower levels	06_183011388_0111_2_2
	Stairs - Seat	Stair lift with seat and rails attached to stairs or incline for ambulant person to ride upstairs on	06_183010387_0111_2_2
	Minor Mods	Home mods - minor step ramp mod supply & fit landings, risers & bilateral hand rails	06_183018403_0111_2_2
Ramps	Minor Step Ramp	Supply and installation of a minor step ramp, with landings and risers to a home.	06_183018402_0111_2_2
	Concrete with Rails	Permanently installed concrete ramp with galvanised rails - per lineal meter	06_183018397_0111_2_2
	Portable - 1200 mm	Portable ramp suitable for outings etc but not permanently affixed	06_183015389_0103_2_2
	Portable - 1350 mm	Portable ramp suitable for outings etc but not permanently affixed	06_183015390_0103_2_2
	Portable - 1650 mm	Portable ramp suitable for outings etc but not permanently affixed	06_183015391_0103_2_2
	Portable - 2000 mm	Portable ramp suitable for outings etc but not permanently affixed	06_183015392_0103_2_2
	Portable - 2000 mm with Edge	Portable ramp suitable for outings etc but not permanently affixed	06_183015393_0103_2_2
	Portable - 700 mm	Portable ramp suitable for outings etc but not permanently affixed	06_183015395_0103_2_2
	Portable - 875 mm	Portable ramp suitable for outings etc but not permanently affixed	06_183015394_0103_2_2
	Portable Stair Climber	Portable stair climber which a wheelchair attaches to and then is tracked upstairs by attendant	06_121703375_0111_2_2
	Temporary 1200 mm x 1200 mm	Temporary removable ramps which are not portable. Modular aluminium removable 1200 mm x 1200 mm (landing)	06_183018401_0111_2_2
	Temporary 2400 mm x 1200 mm	Temporary removable ramps which are not portable - modular aluminium removable 2400 mm x 1200 mm	06_183018398_0111_2_2
	Temporary 2400 mm x 1800 mm	Temporary removable ramps which are not portable - modular aluminium removable 2400 mm x 1800 (landing) mm	06_183018400_0111_2_2
	Temporary 600 mm x 1200 mm	Temporary removable ramps which are not portable - modular aluminium removable 600 mm x 1200 mm	06_183018399_0111_2_2
	Timber	Permanently installed timber ramp with galvanised rails	06_183018396_0111_2_2
Minor Mods	Home mods - minor step ramp mod supply & fit landings, risers & bilateral hand rails	06_183018403_0111_2_2	
	Ramp - <b>Composite</b>		06_426_0111_1_2

NDIS Guide & Pricing Guide, please refer to [www.aidacare.com.au/contracts/national/ndis/](http://www.aidacare.com.au/contracts/national/ndis/)





## MAINTENANCE & SERVICE

*It is Good Practice to have equipment with electrical components and/or moving parts serviced at regular intervals to ensure safety, functionality and longevity.*

*To avoid unforeseen and unbudgeted emergency breakdowns, Aidacare **strongly** recommends including **Preventative Maintenance (PM) and Repair** costs in your participant plan.*

	Equipment Category	NDIS Service Code	NDIS Category
1	Electric Bed	05_501812311_0103_1_2	Repairs - Bed
2	Alternating Air Mattress	05_501812311_0103_1_2	Repairs - Bed
3	Electric Hoist	01_501236025_0103_1_1	Repairs - Hoist
4	Electric Ceiling Hoist	01_501236025_0103_1_1	Repairs - Hoist
5	Transfer Equipment Other	05_501236025_0105_1_2	Repairs - Transfer
6	Manual Wheelchair - Standard	05_501200308_0105_1_2 05_501200307_0105_1_2 05_501224309_0105_1_2	Repairs - Mobility - Major Repairs - Mobility - Standard Repairs - Mobility - Tyres
7	Manual Wheelchair - Customised/Hi End	05_501200308_0105_1_2 05_501200307_0105_1_2 05_501224309_0105_1_2	Repairs - Mobility - Major Repairs - Mobility - Standard Repairs - Mobility - Tyres
8	Manual Wheelchair - Tilt-in-Space	05_501200308_0105_1_2 05_501200307_0105_1_2 05_501224309_0105_1_2	Repairs - Mobility - Major Repairs - Mobility - Standard Repairs - Mobility - Tyres
9	Motorised Wheelchair	05_501200308_0105_1_2 05_501200307_0105_1_2 05_501224310_0105_1_2 05_501224309_0105_1_2	Repairs - Mobility - Major Repairs - Mobility - Standard Repairs - Mobility - Battery/Charger Repairs - Mobility - Tyres
10	Electric Scooter	05_501200308_0105_1_2 05_501200307_0105_1_2 05_501224310_0105_1_2 05_501224309_0105_1_2	Repairs - Mobility - Major Repairs - Mobility - Standard Repairs - Mobility - Battery/Charger Repairs - Mobility - Tyres
11	Mobile Shower Transporter/ Commode	05_500933306_0103_1_2	Repairs - Bathroom
12	Non-Mobility After Hours	05_501288435_0105_1_2	Repairs - Personal Care/ Safety, After-Hours (One Unit)

NDIS Guide & Pricing Guide, please refer to [www.aidacare.com.au/contracts/national/ndis/](http://www.aidacare.com.au/contracts/national/ndis/)



# Start Your NDIS Journey

## Plan & Achieve Your Goals



### STEP ONE Am I Eligible?

Complete the Eligibility Checklist through the NDIS website & answer some simple questions.

*These questions are just a guide, the final decision is decided by the NDIA*

If eligible, you can apply for funding.  
Contact the **NDIA on 1800 800 110** or visit [www.NDIS.gov.au/applying-access-ndis/am-i-eligible](http://www.NDIS.gov.au/applying-access-ndis/am-i-eligible)

### STEP TWO I Have NDIS Approval

Check if NDIS is available to you. The NDIS is rolling out in stages across Australia.

*Find out if this has rolled out in your state or territory*

Contact the **NDIA on 1800 800 110** or visit [www.NDIS.gov.au/understanding/ndis-rollout](http://www.NDIS.gov.au/understanding/ndis-rollout)

## STEP THREE Building Your NDIS Plan

1. Collect information & reports about the supports you need
2. Plan a meeting with LAC or NDIA planner to create your plan
3. Your plan is submitted for approval
4. Receive your approved plan & start accessing supports
5. Aidacare assists OT's to conduct AT Equipment Assessment needs

## STEP FOUR Managing Your Plan

### 1 NDIA Manages Your Plan

- Use only NDIS registered providers to quote services and any ongoing Maintenance
- NDIA coordinates your supports & pays providers for you

### 2 Use a Plan Manager

- Use both NDIS registered & unregistered providers
- Your Plan Manager coordinates your supports & pays providers for you

### 3 Manage Yourself

- Use both NDIS registered & unregistered providers
- You coordinate your own supports & pay providers directly

### 4 A Combination of 1, 2 & 3

- Specific supports are coordinated by NDIS or Plan Manager
- Other supports are managed by you

**aidacare** IS A REGISTERED PROVIDER  
HEALTHCARE EQUIPMENT

**PLAN REVIEW**  
(Usually after 12 Months)

# Index Overview



PRODUCT AND SERVICES  
**CATALOGUE**



Home Modifications  
Refer to Page 12



Bariatric  
Refer to Page 13



Bathroom & Toilet  
Refer to Page 18



Bedroom  
Refer to Page 60



Chair & Table Furnishings  
Refer to Page 99

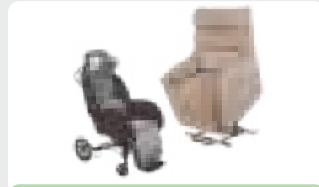

Chairs - Therapeutic  
Refer to Page 107



Contenance  
Refer to Page 123

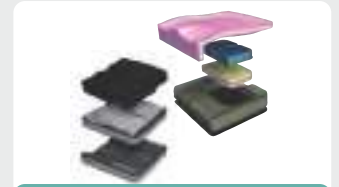

Cushions & Seating  
Refer to Page 131



Daily Living Aids  
Refer to Page 156



Laundry & Cleaning  
Refer to Page 173

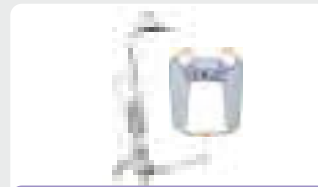

Manual Handling - Lifters  
Refer to Page 184



Manual Handling - Other  
Refer to Page 217



Mobility Scooters  
Refer to Page 224

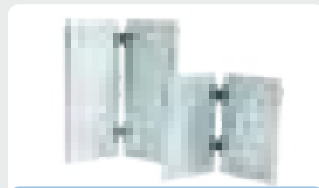

Mobility Ramps  
Refer to Page 233



Mobility Paediatric  
Refer to Page 238



Mobility Walking Frames & Aids  
Refer to Page 252



Mobility Wheelchairs & Positioning  
Refer to Page 271



Utility & Pan Room  
Refer to Page 310



Hospital & Ward Equipment  
Refer to Page 318



Hospital Mortuary & Funeral Homes  
Refer to Page 368



Therapy & Exercise  
Refer to Page 375



Pressure Care & Circulation  
Refer to Page 442



NDIS Assessment  
Refer to Page 503

## Copyright

© Copyright Aidacare Pty Ltd 2019 Version 3.0

No part of this catalogue may be copied, distributed, reproduced, scanned or stored on any electronic database, whether in whole or in part in any form or by any means.

## Disclaimer

Due care has been taken to ensure all the information contained in this catalogue is correct at the time of printing. All measurements, pictures, colours and weight capacities are to be used as a guide only. Our suppliers reserve the right to modify the design or appearance of any product displayed in this catalogue without prior notice.



# aidacare

HEALTHCARE EQUIPMENT



PROPERTY OF:

AIDACARE SALES REPRESENTATIVE:

**1300 133 120**  
[www.aidacare.com.au](http://www.aidacare.com.au)